

Parallel Type Air Gripper/2 Finger, 3 Finger, 4 Finger

MHS Series

ø16, ø20, ø25, ø32, ø40, ø50, ø63, ø80, ø100, ø125

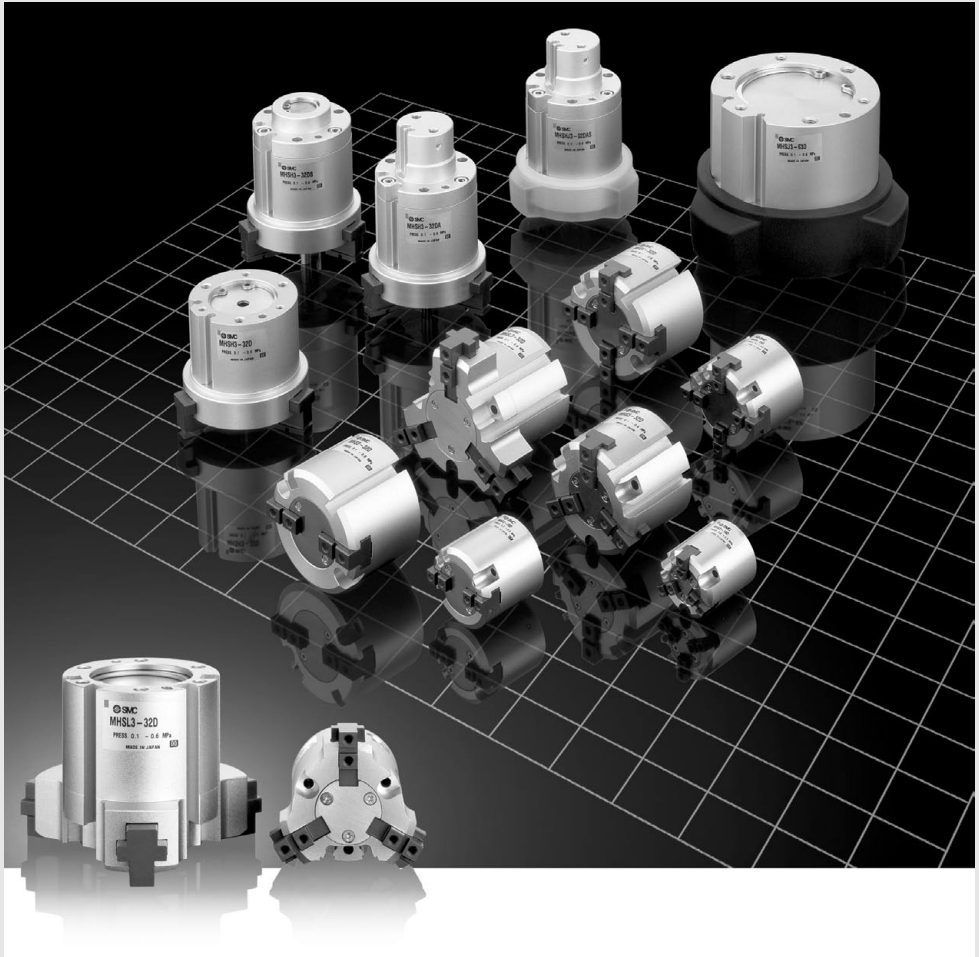

MHZ

MHF

MHL

MHR

MHK

MHS

MHC

MHT

MHY

MHW

-X□

MRHQ

MA

D-□

Lightweight, compact design with reduced height

High repeatability: ± 0.01 mm

Auto switch capable

A wide variety of solid state auto switches can be mounted using the body's side mounting grooves. Selections include 2-color indication and water resistant types.

Easy alignment when mounting

Positioning pin holes are provided on the top of the gripper.

Can be mounted from two directions

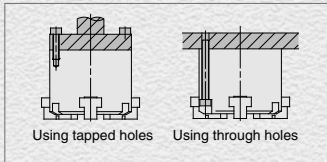

Smaller auto switch mountable

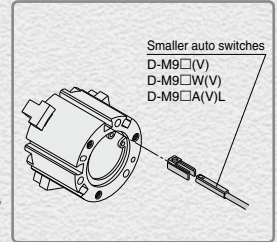

Employs wedge cam construction

The wedge cam mechanism allows strong gripping force to be obtained from a compact design.

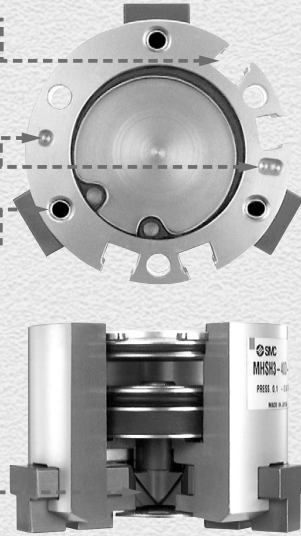

Series Variations

Bore size (mm)

			16	20	25	32	40	50	63	80	100	125	
2-Finger		MHS2 Series Gripping of diverse workpieces	●	●	●	●	●	●	●	●	●	●	P.576
3-Finger		MHS3 Series Axial gripping of cylindrical workpieces	●	●	●	●	●	●	●	●	●	●	P.584
3-Finger		Long stroke MHS3 Series Accommodates a wide range of workpiece diameters	●	●	●	●	●	●	●	●	●	●	P.618
4-Finger		MHS4 Series Positioning of square workpieces	●	●	●	●	●	●	●	●	●	●	P.628

Ideal for gripping workpieces of different diameters

MHSL3 Long Stroke

P.618

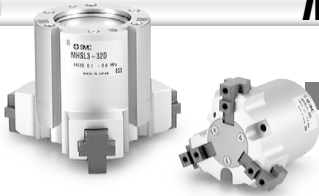

Opening/Closing stroke more than twice the standard (MHS3)

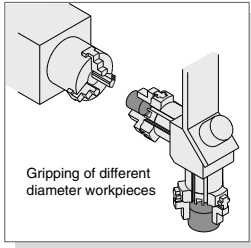

● The mounting pitch is compatible with the standard type.

Bore size (mm)	Stroke (mm)	Height (mm)	Weight (g)
	Dia.: Open - Closed		
16	10 (4)	43.5	80
20	12 (6)	46	135
25	16 (8)	49	180
32	20 (8)	58	370
40	28 (12)	64	550
50	32 (16)	77.5	930
63	40 (20)	89	1,550
80	48 (24)	116	2,850
100	64 (32)	135	5,500
125	64 (32)	175	11,300

Standard inside () MHS3 stroke

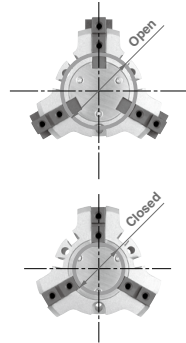

MHS3 Variations

With dust cover/MHSJ3



P.594

Through-hole/MHSH3

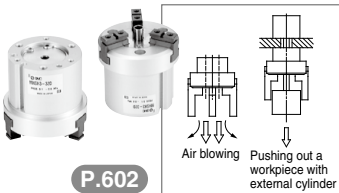

P.602

Single acting/MHS3-X84

ø16, ø20, ø25, ø32, ø40, ø50, ø63

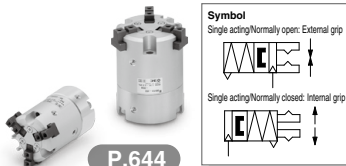

P.644

Bore size (mm)

16 20 25 32 40 50 63 80

Model	Configuration	16	20	25	32	40	50	63	80
MHSJ3	With dust cover	●	●	●	●	●	●	●	●
MHSH3	Through-hole	○	○	○	○	○	○	○	○
	With center pusher (Cylinder type)	○	○	○	○	○	○	○	○
MHSHJ3	With center pusher (Spring type)	○	○	○	○	○	○	○	○
	Through-hole with dust cover	○	○	○	○	○	○	○	○
MHS3-X84	With dust cover/Center pusher (Cylinder type)	○	○	○	○	○	○	○	○
	With dust cover/Center pusher (Spring type)	○	○	○	○	○	○	○	○
MHS3-X84	Single acting (Normally open, Normally closed)	○	○	○	○	○	○	○	○

With dust cover/Center pusher



The dust cover and center pusher assembly can be modularized for the through-hole MHSH3.

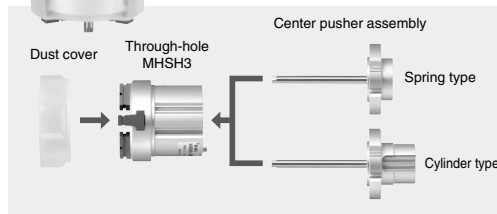

MHZ

MHF

MHL

MHR

MHK

MHS

MHC

MHT

MHY

MHW

-X□

MRHQ

MA

D-□

Added single acting (Made to Order -X84) to 3-finger type (MHS3 Series).

ø16, ø20, ø25, ø32, ø40, ø50, ø63

Normally open or normally closed type can be selected.

P.644



Port position can be changed according to installation conditions.

The piping can be connected from the side port or top port of the body, which allows for improved piping flexibility.

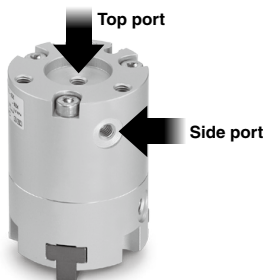

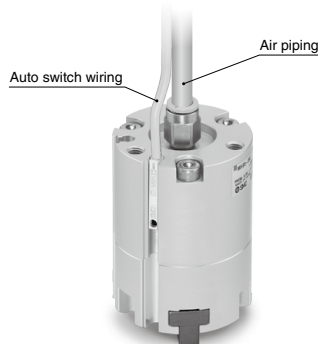

Piping and auto switch wiring entries are one way. (For top ported)

Space reduced through integration of air piping and auto switch wiring.



Series Variations

Series		Action	Bore size [mm]									
			16	20	25	32	40	50	63	80	100	125
	MHS3	Double acting	●	●	●	●	●	●	●	●	●	●
		Single acting	Normally open	●	●	●	●	●	●	●	—	—
		Normally closed	●	●	●	●	●	●	●	—	—	—

MHZ

MHF

MHL

MHR

MHK

MHS

MHC

MHT

MHY

MHW

-X□

MRHQ

MA

D-□

MHS Series Model Selection

Model Selection

Selection Procedure



Step 1 Confirmation of Greeting Force



Example

Workpiece mass: 0.4 kg

Gripping method: External gripping

Number of fingers: 2

Model selection criteria with respect to workpiece weight

- Although differences will exist depending on the coefficient of friction between attachments and workpieces, select a model which will provide a gripping force as shown in the table below.
- Note 1) Refer to the model selection illustration regarding multiples of the workpiece weight.

Model	Multiples of gripping force by workpiece weight
MHS2	10 to 20 times or more
MHS3	7 to 13 times or more
MHSJ3	
MHSH3	
MHSL3	5 to 10 times or more
MHS4	

- If high acceleration, deceleration or impact forces are encountered during motion, a further margin of safety should be considered.
- Example) When it is desired to set the gripping force at 20 times or more above the workpiece weight.
Required gripping force
= 0.4 kg x 20 x 9.8 m/s² = 78.4 N or more

Gripping point: 20 mm

Operating pressure: 0.4 MPa

MHS2-32D

External Gripping Force

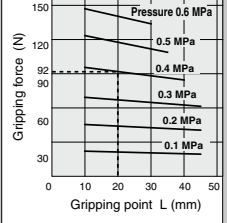

Selecting the MHS2-32D

A gripping force of 92 N is obtained from the intersection point of the gripping point distance L = 20 mm and a pressure of 0.4 MPa.

- The gripping force is 23 times greater than the workpiece mass, and therefore satisfies a gripping force setting value of 20 times or more.

Note) For Step 2, refer to the gripping point for the effective gripping force of each model.

Model Selection Illustration

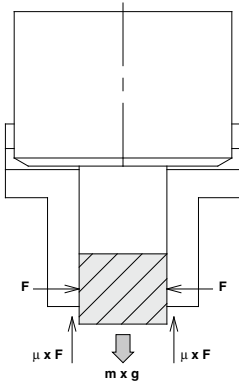

When gripping a workpiece as in the figure to the left, and with the following definitions,

- n**: Number of fingers
- F**: Gripping force (N)
- μ**: Coefficient of friction between attachments and workpiece
- m**: Workpiece mass (kg)
- g**: Gravitational acceleration (= 9.8 m/s²)
- mg**: Workpiece weight (N)

the conditions under which the workpiece will not drop are

$$n \times \mu F > mg$$

and therefore,

$$F > \frac{mg}{n \times \mu}$$

With "a" as the safety margin, **F** is determined as follows:

$$F = \frac{a \times mg}{n \times \mu}$$

Multiples of Gripping Force by Workpiece Mass

Number of fingers: When n = 2

- SMC performs calculations allowing for impacts which occur during normal transfer, etc., using a safety margin of a = 4.

When $\mu = 0.2$	When $\mu = 0.1$
$F = \frac{mg}{2 \times 0.2} \times 4$ $= 10 \times mg$	$F = \frac{mg}{2 \times 0.1} \times 4$ $= 20 \times mg$
<div style="border: 1px solid black; padding: 2px; width: fit-content; margin: 0 auto;">10 x workpiece weight</div>	<div style="border: 1px solid black; padding: 2px; width: fit-content; margin: 0 auto;">20 x workpiece weight</div>

Note) • Even in cases where the coefficient of friction is greater than $\mu = 0.2$, for safety reasons, SMC recommends selecting a gripping force which is at least 10 to 20 times the workpiece weight.

- If high acceleration, deceleration or impact forces are encountered during motion, a further margin of safety should be considered.

- MHZ
- MHF
- MHL
- MHR
- MHK
- MHS
- MHC
- MHT
- MHY
- MHW
- X□
- MRHQ
- MA
- D-□

Parallel Type Air Gripper/2-Finger Type

MHS2 Series

ø16, ø20, ø25, ø32, ø40, ø50, ø63

How to Order

Bore size

ø16 to ø25 **MHS2 - 20D - M9BW** [] - []

Number of fingers: 2 | 2 fingers

Bore size: 16 | 16 mm, 20 | 20 mm, 25 | 25 mm

Action: D | Double acting

Auto switch: Nil | Without auto switch (Built-in magnet), S | For the applicable auto switch model, refer to the table below.

Number of auto switches: Nil | 2 pcs., S | 1 pc.

Made to Order: Refer to page 577 for details.

Applicable Auto Switches/Refer to pages 797 to 850 for further information on auto switches.

Type	Special function	Electrical entry	Indicator light	Wiring (Output)	Load voltage		Auto switch model		Lead wire length (m)*			Pre-wired connector	Applicable load		
					DC	AC	Perpendicular	In-line	0.5 (Nil)	1 (M)	3 (L)			5 (Z)	
Solid state auto switch	—	Grommet	Yes	3-wire (NPN)	5 V,	24 V	—	M9NV	M9N	●	●	○	○	Relay, PLC	
				3-wire (PNP)	12 V			M9PV	M9P	●	●	○	○		
				2-wire	12 V			M9BV	M9B	●	●	○	○		
				3-wire (NPN)	5 V,			M9NVW	M9NW	●	●	○	○		
				3-wire (PNP)	12 V			M9PVW	M9PW	●	●	○	○		
				2-wire	12 V			M9BWW	M9BW	●	●	○	○		
	Diagnosis (2-color indicator)			3-wire (NPN)	5 V,			M9NAV**	M9NA**	○	○	●	○		IC circuit
				3-wire (PNP)	12 V			M9PAV**	M9PA**	○	○	○	●		
				2-wire	12 V			M9BAV**	M9BA**	○	○	○	○		
				3-wire (NPN)	5 V,			M9NAV**	M9NA**	○	○	●	○		
				3-wire (PNP)	12 V			M9PAV**	M9PA**	○	○	○	●		
				2-wire	12 V			M9BAV**	M9BA**	○	○	○	○		
Water resistant (2-color indicator)	3-wire (NPN)	5 V,	M9NAV**	M9NA**	○	○	●	○	IC circuit						
	3-wire (PNP)	12 V	M9PAV**	M9PA**	○	○	○	●							
	2-wire	12 V	M9BAV**	M9BA**	○	○	○	○							
	3-wire (NPN)	5 V,	M9NAV**	M9NA**	○	○	●	○							
	3-wire (PNP)	12 V	M9PAV**	M9PA**	○	○	○	●							
	2-wire	12 V	M9BAV**	M9BA**	○	○	○	○							

** Water resistant type auto switches can be mounted on the above models, but in such case SMC cannot guarantee water resistance.

* Lead wire length symbols: 0.5 m Nil (Example) M9N * Auto switches marked with a "O" symbol are produced upon receipt of order.

1 m M (Example) M9NW
3 m L (Example) M9NL
5 m Z (Example) M9NZ

Note) When using the 2-color indicator type, please make the setting so that the indicator is lit in red to ensure the detection at the proper position of the air gripper.

Bore size

ø32 to ø63 **MHS2 - 50D - M9BW** [] - []

Number of fingers: 2 | 2 fingers

Bore size: 32 | 32 mm, 40 | 40 mm, 50 | 50 mm, 63 | 63 mm

Action: D | Double acting

Auto switch: Nil | Without auto switch (Built-in magnet), S | For the applicable auto switch model, refer to the table below.

Number of auto switches: Nil | 2 pcs., S | 1 pc.

Made to Order: Refer to page 577 for details.

Applicable Auto Switches/Refer to pages 797 to 850 for further information on auto switches.

Type	Special function	Electrical entry	Indicator light	Wiring (Output)	Load voltage		Auto switch model		Lead wire length (m)*			Pre-wired connector	Applicable load		
					DC	AC	Perpendicular	In-line	0.5 (Nil)	1 (M)	3 (L)			5 (Z)	
Solid state auto switch	—	Grommet	Yes	3-wire (NPN)	5 V,	24 V	—	M9NV	M9N	●	●	○	○	Relay, PLC	
				3-wire (PNP)	12 V			M9PV	M9P	●	●	○	○		
				2-wire	12 V			M9BV	M9B	●	●	○	○		
				3-wire (NPN)	5 V,			M9NVW	M9NW	●	●	○	○		
				3-wire (PNP)	12 V			M9PVW	M9PW	●	●	○	○		
				2-wire	12 V			M9BWW	M9BW	●	●	○	○		
	Diagnosis (2-color indicator)			3-wire (NPN)	5 V,			M9NAV**	M9NA**	○	○	●	○		IC circuit
				3-wire (PNP)	12 V			M9PAV**	M9PA**	○	○	○	●		
				2-wire	12 V			M9BAV**	M9BA**	○	○	○	○		
				3-wire (NPN)	5 V,			M9NAV**	M9NA**	○	○	●	○		
				3-wire (PNP)	12 V			M9PAV**	M9PA**	○	○	○	●		
				2-wire	12 V			M9BAV**	M9BA**	○	○	○	○		
Water resistant (2-color indicator)	3-wire (NPN)	5 V,	M9NAV**	M9NA**	○	○	●	○	IC circuit						
	3-wire (PNP)	12 V	M9PAV**	M9PA**	○	○	○	●							
	2-wire	12 V	M9BAV**	M9BA**	○	○	○	○							
	3-wire (NPN)	5 V,	M9NAV**	M9NA**	○	○	●	○							
	3-wire (PNP)	12 V	M9PAV**	M9PA**	○	○	○	●							
	2-wire	12 V	M9BAV**	M9BA**	○	○	○	○							

** Water resistant type auto switches can be mounted on the above models, but in such case SMC cannot guarantee water resistance.

* Lead wire length symbols: 0.5 m Nil (Example) M9N * Auto switches marked with a "O" symbol are produced upon receipt of order.

1 m M (Example) M9NW
3 m L (Example) M9NL
5 m Z (Example) M9NZ

Note 1) When using the 2-color indicator type, please make the setting so that the indicator is lit in red to ensure the detection at the proper position of the air gripper.

Note 2) When ordering the air gripper with auto switch, auto switch mounting brackets are supplied with the air gripper having a bore size of ø32 to ø63.

Note 3) When ordering the auto switch separately, auto switch mounting brackets (BMG2-012) are required.

Model/Specifications



Model		MHS2-16D	MHS2-20D	MHS2-25D	MHS2-32D	MHS2-40D	MHS2-50D	MHS2-63D
Bore size (mm)		16	20	25	32	40	50	63
Fluid		Air						
Operating pressure (MPa)		0.2 to 0.6			0.1 to 0.6			
Ambient and fluid temperature (°C)		-10 to 60						
Repeatability (mm)		±0.01						
Max. operating frequency (c.p.m.)		120			60			
Lubrication		Not required						
Action		Double acting						
Effective gripping force (N) at 0.5 MPa <small>(Note)</small>	External grip	21	37	63	111	177	280	502
	Internal grip	23	42	71	123	195	306	537
Opening/Closing stroke (Both sides) (mm)		4	4	6	8	8	12	16
Weight (g)		58	96	134	265	345	515	952

(Note) Values for $\phi 16$ to $\phi 25$ are with gripping point $L = 20$ mm, and for $\phi 32$ to $\phi 63$ with gripping point $L = 30$ mm.
Refer to "Effective Gripping Force" data on pages 579 and 580 for the gripping force at each gripping position.

Symbol

Double acting:
Internal grip

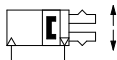

Double acting:
External grip

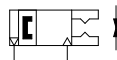

 **Made to Order**
[Click here for details](#)

Symbol	Specifications/Description
-X4	Heat resistance (100°C)
-X5	Fluororubber seal
-X50	Without magnet
-X53	EPDM seal/Fluorine grease
-X56	Axial ported
-X63	Fluorine grease
-X79	Grease for food processing machines, Fluorine grease
-X79A	Grease for food processing machines

Refer to pages 636 to 643 for the specifications of products with auto switches.

- Auto switch installation examples and mounting positions
- Auto switch hysteresis
- Auto switch mounting
- Protrusion of auto switch from edge of body

MHZ

MHF

MHL

MHR

MHK

MHS

MHC

MHT

MHY

MHW

-X□

MRHQ

MA

D-□

MHS2 Series

Construction

Closed condition

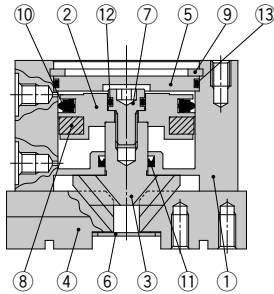

Open condition

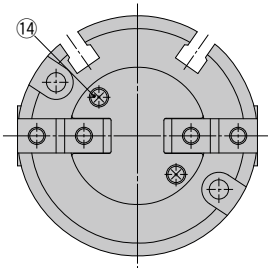
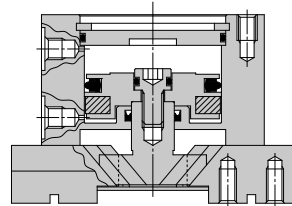

Component Parts

No.	Description	Material	Note
1	Body	Aluminum alloy	Hard anodized
2	Piston	Aluminum alloy	Hard anodized
3	Cam	Carbon steel	Heat treated, Specially treated
4	Finger	Carbon steel	Heat treated, Specially treated
5	Cap	Aluminum alloy	Hard anodized
6	End plate	Stainless steel	
7	Piston bolt	Stainless steel	

No.	Description	Material	Note
8	Magnet	—	
9	Type C retaining ring	Carbon steel	Phosphate coated
10	Piston seal	NBR	
11	Rod seal	NBR	
12	Gasket	NBR	
13	Gasket	NBR	
14	Cross recessed flat head screw	Carbon steel	Zinc chromated

Replacement Parts

Description	MHS2-16D	MHS2-20D	MHS2-25D	MHS2-32D	MHS2-40D	MHS2-50D	MHS2-63D	Main parts
Seal kit	MHS16-PS	MHS20-PS	MHS25-PS	MHS32-PS	MHS40-PS	MHS50-PS	MHS63-PS	⑩⑪⑫⑬
Finger	P3316004	P3346104	P3316204	P3316304	P3316404	P3316504	P3316604	④
Cam	P3316023	P3316123	P3316223	P3316323	P3316423	P3316523	P3316623	③
Piston assembly	MHS-A1601	MHS-A2001	MHS-A2501	MHS-A3201	MHS-A4001	MHS-A5001	MHS-A6301	②⑦⑧
End plate assembly	MHS-A1613-2	MHS-A2013-2	MHS-A2513-2	MHS-A3213-2	MHS-A4013-2	MHS-A5013-2	MHS-A6313-2	⑥⑭
Cap	MHS-A1614	MHS-A2014	MHS-A2514	MHS-A3214	MHS-A4014	MHS-A5014	MHS-A6314	⑤

* Order 2 pieces of fingers for one unit.

Replacement part/Grease pack part no.: MH-G01 (30 g)

Gripping Point

- The workpiece gripping point distance should be within the gripping force ranges given for each pressure in the effective gripping force graphs below.
- If operated with the workpiece gripping point beyond the indicated ranges, an excessive offset load will be applied to the sliding section of the fingers, which can have an adverse effect on the service life of the product.
- If there is an overhang, please consult with SMC.

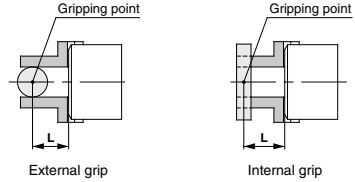

L: Gripping point distance

Effective Gripping Force

- Indication of effective gripping force
The effective gripping force shown in the graphs to the right is expressed as F , which is the thrust of one finger, when both fingers and attachments are in full contact with the workpiece as shown in the figure below.

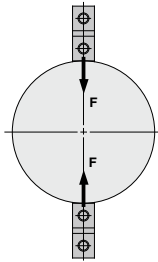

External grip

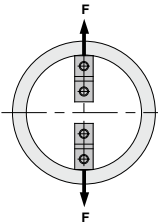

Internal grip

External Grip

MHS2-16D

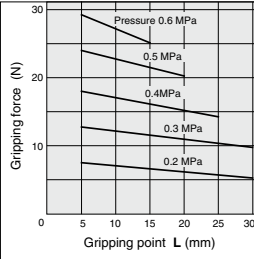

MHS2-20D

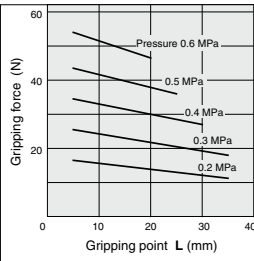

MHS2-25D

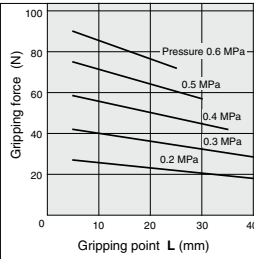

Internal Grip

MHS2-16D

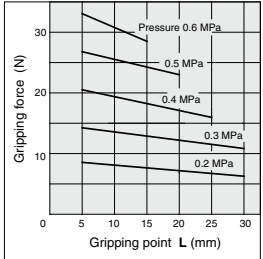

MHS2-20D

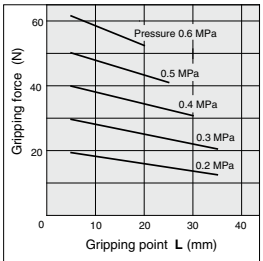

MHS2-25D

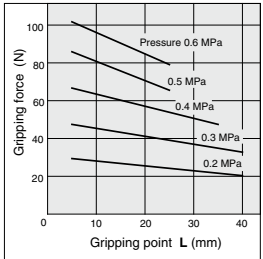

MHZ

MHF

MHL

MHR

MHK

MHS

MHC

MHT

MHY

MHW

-X

MRHQ

MA

D-

MHS2 Series

Effective Gripping Force

• Indication of effective gripping force

The effective gripping force shown in the graphs to the right is expressed as F , which is the thrust of one finger, when both fingers and attachments are in full contact with the workpiece as shown in the figure below.

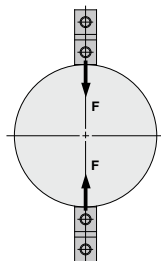

External grip

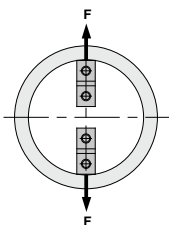

Internal grip

External Grip

MHS2-32D

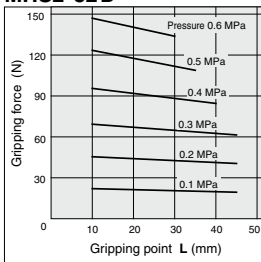

MHS2-40D

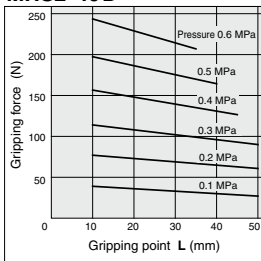

MHS2-50D

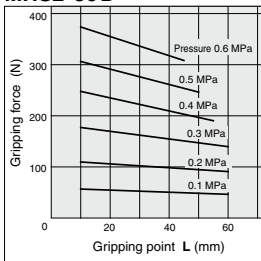

MHS2-63D

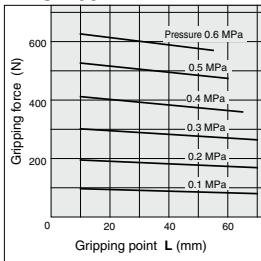

Internal Grip

MHS2-32D

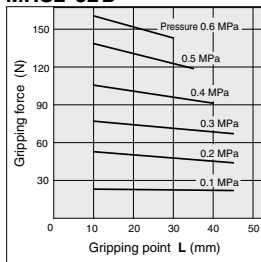

MHS2-40D

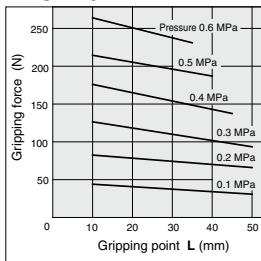

MHS2-50D

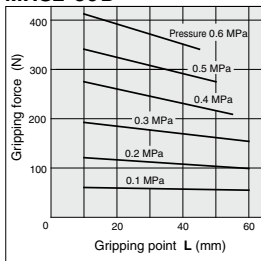

MHS2-63D

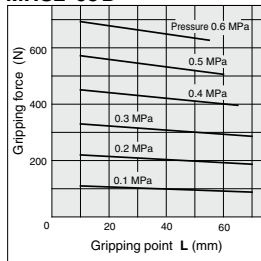

Dimensions

MHS2-16D to 25D

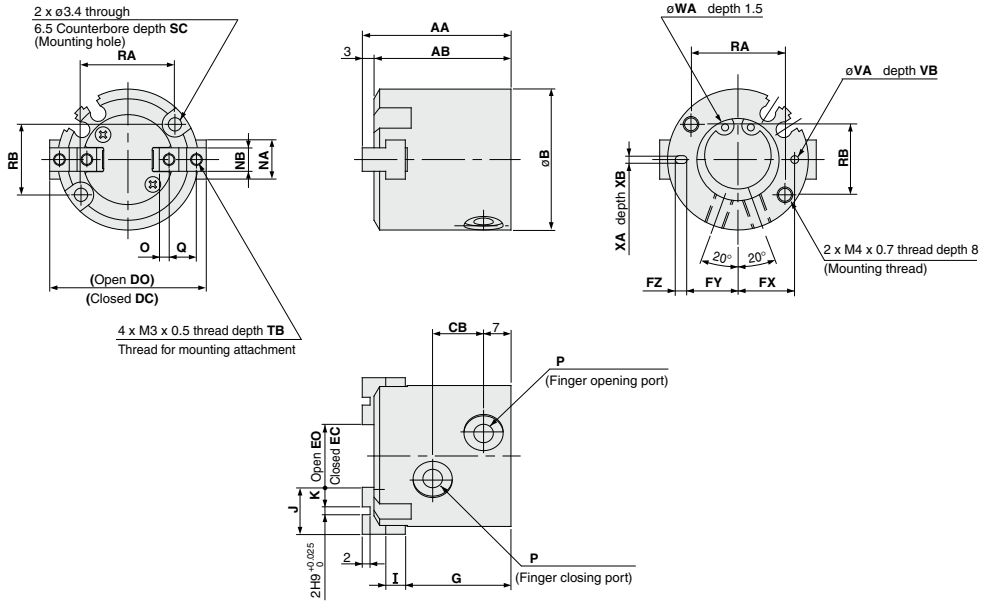

Auto switch mounting groove dimensions (2 locations)

MHS2-16D

MHS2-20D

MHS2-25D

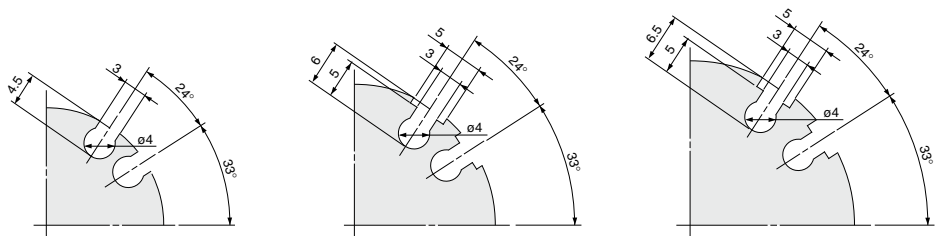

Model	AA	AB	B	CB	DC	DO	EC	EO	FX	FY	FZ	G	I	J	K	NA	NB	O	P	Q
MHS2-16D	35	32	30	11	30	34	10	14	12.5	11	3	25	4	10	4	8	5h9 ₀ ^{0.030}	2	M3 x 0.5	6
MHS2-20D	38	35	36	13	36	40	12	16	14.5	13	3	27	5	12	5	10	6h9 ₀ ^{0.030}	2.5	M5 x 0.8	7
MHS2-25D	40	37	42	15	42	48	14	20	17	14.5	5	28	5	14	6	12	6h9 ₀ ^{0.030}	3	M5 x 0.8	8

Model	RA	RB	SC	TB	VA	VB	WA	XA	XB
MHS2-16D	18	16	8	5	2H9 ^{+0.025} ₀	2	17H9 ^{+0.043} ₀	2H9 ^{+0.025} ₀	2
MHS2-20D	24	18	9.5	6	2H9 ^{+0.025} ₀	2	21H9 ^{+0.052} ₀	2H9 ^{+0.025} ₀	2
MHS2-25D	26	22	10	6	3H9 ^{+0.025} ₀	3	26H9 ^{+0.052} ₀	3H9 ^{+0.025} ₀	3

- MHZ
- MHF
- MHL
- MHR
- MHK
- MHS**
- MHC
- MHT
- MHY
- MHW
- X□
- MRHQ
- MA
- D-□

MHS2 Series

Dimensions

MHS2-32D/40D

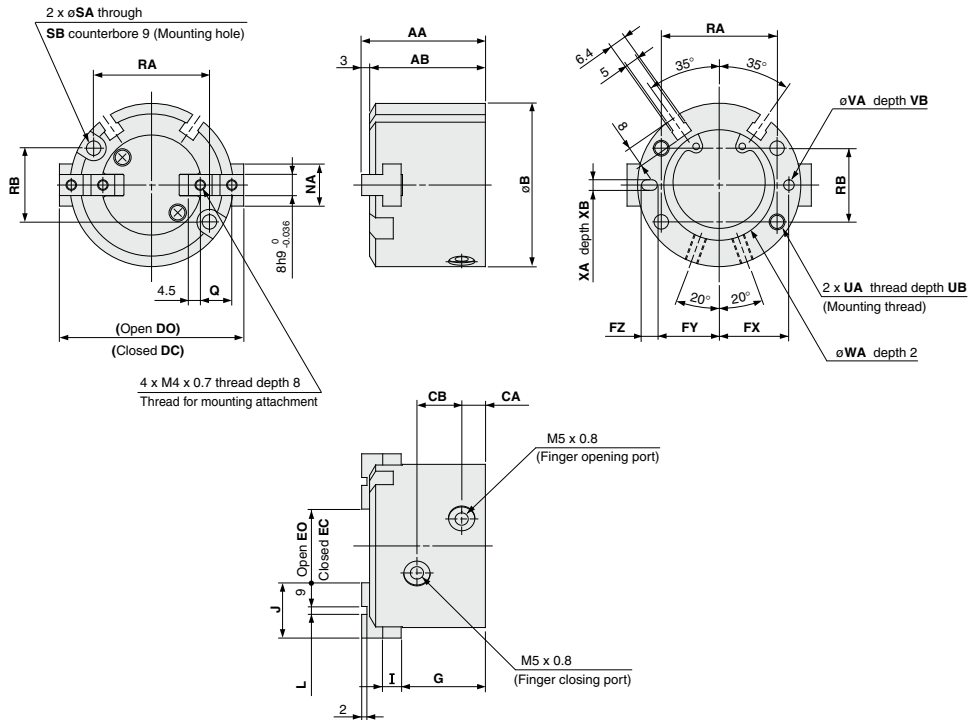

(mm)

Model	AA	AB	B	CA	CB	DC	DO	EC	EO	FX	FY	FZ	G	I	J	L	NA	Q	RA	RB	SA	
MHS2-32D	44	41	56	8	16	56	64	16	24	23	20.5	5	30.5	6	20	2H9 $\begin{smallmatrix} +0.025 \\ 0 \end{smallmatrix}$	14	11	38	25	4.5	
MHS2-40D	47	44	62	9	17	62	70	20	28	26.5	23.5	6	32	7	21	3H9 $\begin{smallmatrix} +0.025 \\ 0 \end{smallmatrix}$	16	12	44	28	5.5	
Model	SB	UA	UB	VA	VB	WA	XA	XB														
MHS2-32D	8	M5 x 0.8	10	3H9 $\begin{smallmatrix} +0.025 \\ 0 \end{smallmatrix}$	3	34H9 $\begin{smallmatrix} +0.062 \\ 0 \end{smallmatrix}$	3H9 $\begin{smallmatrix} +0.025 \\ 0 \end{smallmatrix}$	3														
MHS2-40D	9.5	M6 x 1	12	4H9 $\begin{smallmatrix} +0.030 \\ 0 \end{smallmatrix}$	4	42H9 $\begin{smallmatrix} +0.062 \\ 0 \end{smallmatrix}$	4H9 $\begin{smallmatrix} +0.030 \\ 0 \end{smallmatrix}$	4														

MHS2-50D/63D

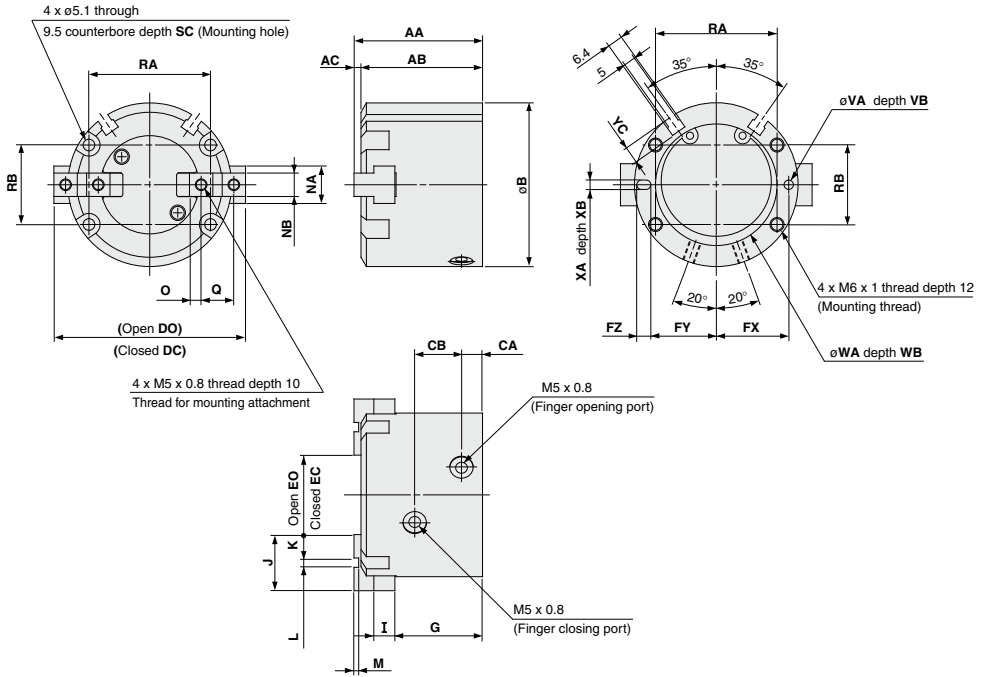

Model	AA	AB	AC	B	CA	CB	DC	DO	EC	EO	FX	FY	FZ	G	I	J	K	L	M	NA	NB
MHS2-50D	55	52	3	70	9	20	70	82	22	34	31	28	6	37.5	9	24	10	4H9 ⁰ / ₀ ^{+0.030}	2	18	10h9 ⁰ / ₀ ^{-0.036}
MHS2-63D	66	62	4	86	12	22	86	102	30	46	38	34.5	7	44	11	28	11	6H9 ⁰ / ₀ ^{+0.030}	3	24	12h9 ⁰ / ₀ ^{-0.043}

Model	O	Q	RA	RB	SC	VA	VB	WA	WB	XA	XB	YC
MHS2-50D	5	14	52	34	12	4H9 ⁰ / ₀ ^{+0.030}	4	52H9 ⁰ / ₀ ^{+0.074}	2	4H9 ⁰ / ₀ ^{+0.030}	4	7
MHS2-63D	5.5	17	66	38	14	5H9 ⁰ / ₀ ^{+0.030}	5	65H9 ⁰ / ₀ ^{+0.074}	2.5	5H9 ⁰ / ₀ ^{+0.030}	5	7.5

MHS2 Series Detailed dimensions of mounting portion of end plate

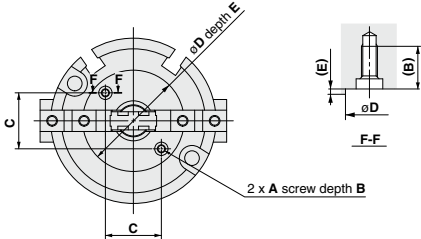

Model	A	B	C	øD	E
MHS2-16D	M2 x 0.4	5.5	11	21 ^{+0.1} / ₀	0.5
MHS2-20D		5.4	13	24 ^{+0.1} / ₀	0.6
MHS2-25D		5.2	15	27 ^{+0.1} / ₀	0.8
MHS2-32D	M3 x 0.5	5.2	18	32 ^{+0.1} / ₀	0.8
MHS2-40D		8	21	38 ^{+0.1} / ₀	1
MHS2-50D		8	24	42 ^{+0.1} / ₀	1
MHS2-63D		32	54	54 ^{+0.1} / ₀	

- MHZ
- MHF
- MHL
- MHR
- MHK
- MHS
- MHC
- MHT
- MHY
- MHW
- X□
- MRHQ
- MA
- D-□

Parallel Type Air Gripper/3-Finger Type MHS3 Series

ø16, ø20, ø25, ø32, ø40, ø50, ø63, ø80, ø100, ø125

How to Order

Bore size

ø16 to ø25 **MHS3 - 20D - M9BW** - [] - []

Number of fingers: 3 (3 fingers)

Bore size: 20 (20 mm)

Action: D (Double acting)

Auto switch: Nil (Without auto switch (Built-in magnet))

Number of auto switches: S (1 pc.)

Made to Order
Refer to page 585 for details.

Applicable Auto Switches/Refer to pages 797 to 850 for further information on auto switches.

Type	Special function	Electrical entry	Indicator light	Wiring (Output)	Load voltage		Auto switch model		Lead wire length (m)*			Pre-wired connector	Applicable load	
					DC	AC	Perpendicular	In-line	0.5 (Nil)	1 (M)	3 (L)			5 (Z)
Solid state auto switch	—	Grommet	Yes	3-wire (NPN)	24 V	5 V, 12 V	—	M9NV	M9N	●	●	○	○	Relay, PLC
				3-wire (PNP)				M9PV	M9P	●	●	○	○	
				2-wire				M9BV	M9B	●	●	○	○	
				3-wire (NPN)				M9NVW	M9NW	●	●	○	○	
				3-wire (PNP)				M9PVW	M9PW	●	●	○	○	
				2-wire				M9BWV	M9BW	●	●	○	○	
	Diagnosis (2-color indicator)	Grommet	Yes	3-wire (NPN)	24 V	5 V, 12 V	—	M9NAV**	M9NA**	○	○	●	○	Relay, PLC
				3-wire (PNP)				M9PAV**	M9PA**	○	○	●	○	
				2-wire				M9BAV**	M9BA**	○	○	●	○	
				3-wire (NPN)				M9NVW	M9NW	●	●	○	○	
				3-wire (PNP)				M9PVW	M9PW	●	●	○	○	
				2-wire				M9BWV	M9BW	●	●	○	○	
Water resistant (2-color indicator)	Grommet	Yes	3-wire (NPN)	24 V	5 V, 12 V	—	M9NAV**	M9NA**	○	○	●	○	Relay, PLC	
			3-wire (PNP)				M9PAV**	M9PA**	○	○	●	○		
			2-wire				M9BAV**	M9BA**	○	○	●	○		
			3-wire (NPN)				M9NVW	M9NW	●	●	○	○		
			3-wire (PNP)				M9PVW	M9PW	●	●	○	○		
			2-wire				M9BWV	M9BW	●	●	○	○		

** Water resistant type auto switches can be mounted on the above models, but in such case SMC cannot guarantee water resistance.
 * Lead wire length symbols: 0.5 m Nil (Example) M9N
 1 m M (Example) M9NW
 3 m L (Example) M9NL
 5 m Z (Example) M9NZ
 * Auto switches marked with a "○" symbol are produced upon receipt of order.

Note) When using the 2-color indicator type, please make the setting so that the indicator is lit in red to ensure the detection at the proper position of the air gripper.

Bore size

ø32 to ø125 **MHS3 - 50D - M9BW** - [] - []

Number of fingers: 3 (3 fingers)

Bore size: 50 (50 mm)

Action: D (Double acting)

Port thread type: Nil (M thread, ø32 to ø63), Rc (ø32 to ø63), TN (NPT, ø80 to ø125), TF (G)

Number of auto switch: S (1 pc.)

Made to Order
Refer to page 585 for details.

Applicable Auto Switches/Refer to pages 797 to 850 for further information on auto switches.

Type	Special function	Electrical entry	Indicator light	Wiring (Output)	Load voltage		Auto switch model		Lead wire length (m)*			Pre-wired connector	Applicable load	
					DC	AC	Perpendicular	In-line	0.5 (Nil)	1 (M)	3 (L)			5 (Z)
Solid state auto switch	—	Grommet	Yes	3-wire (NPN)	24 V	5 V, 12 V	—	M9NV	M9N	●	●	○	○	Relay, PLC
				3-wire (PNP)				M9PV	M9P	●	●	○	○	
				2-wire				M9BV	M9B	●	●	○	○	
				3-wire (NPN)				M9NVW	M9NW	●	●	○	○	
				3-wire (PNP)				M9PVW	M9PW	●	●	○	○	
				2-wire				M9BWV	M9BW	●	●	○	○	
	Diagnosis (2-color indicator)	Grommet	Yes	3-wire (NPN)	24 V	5 V, 12 V	—	M9NAV**	M9NA**	○	○	●	○	Relay, PLC
				3-wire (PNP)				M9PAV**	M9PA**	○	○	●	○	
				2-wire				M9BAV**	M9BA**	○	○	●	○	
				3-wire (NPN)				M9NVW	M9NW	●	●	○	○	
				3-wire (PNP)				M9PVW	M9PW	●	●	○	○	
				2-wire				M9BWV	M9BW	●	●	○	○	
Water resistant (2-color indicator)	Grommet	Yes	3-wire (NPN)	24 V	5 V, 12 V	—	M9NAV**	M9NA**	○	○	●	○	Relay, PLC	
			3-wire (PNP)				M9PAV**	M9PA**	○	○	●	○		
			2-wire				M9BAV**	M9BA**	○	○	●	○		
			3-wire (NPN)				M9NVW	M9NW	●	●	○	○		
			3-wire (PNP)				M9PVW	M9PW	●	●	○	○		
			2-wire				M9BWV	M9BW	●	●	○	○		

** Water resistant type auto switches can be mounted on the above models, but in such case SMC cannot guarantee water resistance.
 * Lead wire length symbols: 0.5 m Nil (Example) M9NV
 1 m M (Example) M9NVW
 3 m L (Example) M9NWL
 5 m Z (Example) M9NVZ
 * Auto switches marked with a "○" symbol are produced upon receipt of order.

Note 1) When using the 2-color indicator type, please make the setting so that the indicator is lit in red to ensure the detection at the proper position of the air gripper.
 Note 2) When ordering the air gripper with auto switch, auto switch mounting brackets are supplied with the air gripper having a bore size of ø32 to ø125.
 Note 3) When ordering the auto switch separately, auto switch mounting brackets (BMG2-012) are required.

Models/Specifications

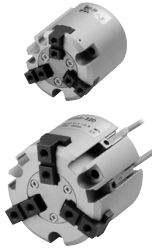

Model	MHS3-16D	MHS3-20D	MHS3-25D	MHS3-32D	MHS3-40D	MHS3-50D	MHS3-63D	MHS3-80D	MHS3-100D	MHS3-125D	
Cylinder bore size (mm)	16	20	25	32	40	50	63	80	100	125	
Fluid	Air										
Operating pressure (MPa)	0.2 to 0.6			0.1 to 0.6							
Ambient and fluid temperature (°C)	-10 to 60										
Repeatability (mm)	±0.01										
Max. operating frequency (c.p.m.)	120			60				30			
Lubrication	Not required										
Action	Double acting										
Effective gripping force (N) at 0.5 MPa <small>Note 1)</small>	External grip	14	25	42	74	118	187	335	500	750	1,270
	Internal grip	16	28	47	82	130	204	359	525	780	1,320
Opening/Closing stroke (mm) (dia.)	4	4	6	8	8	12	16	20	24	32	
Weight (g)	60	100	140	237	351	541	992	1,850	3,340	6,460	

Note 1) Values for $\phi 16$ to $\phi 25$ are with gripping point $L = 20$ mm, for $\phi 32$ to $\phi 63$ with gripping point $L = 30$ mm, and for $\phi 80$ to $\phi 125$ with gripping point $L = 50$ mm. Refer to "Effective Gripping Force" data on pages 587 to 589 for the gripping force at each gripping position.

Symbol

Double acting:
Internal grip

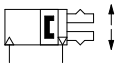

Double acting:
External grip

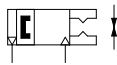

Made to Order: Individual Specifications

(For details, refer to pages 644 to 654.)

Symbol	Specifications/Description
-X84	Single acting ($\phi 16$ to $\phi 63$)



Made to Order

[Click here for details](#)

Symbol	Specifications/Description
-X4	Heat resistance (100°C)
-X5	Fluororubber seal
-X50	Without magnet
-X53	EPDM seal/Fluorine grease
-X56	Axial ported
-X63	Fluorine grease
-X79	Grease for food processing machines, Fluorine grease
-X79A	Grease for food processing machines

Refer to pages 636 to 643 for the specifications of products with auto switches.

- Auto switch installation examples and mounting positions
- Auto switch hysteresis
- Auto switch mounting
- Protrusion of auto switch from edge of body

MHZ

MHF

MHL

MHR

MHK

MHS

MHC

MHT

MHY

MHW

-X□

MRHQ

MA

D-□

MHS3 Series

Construction

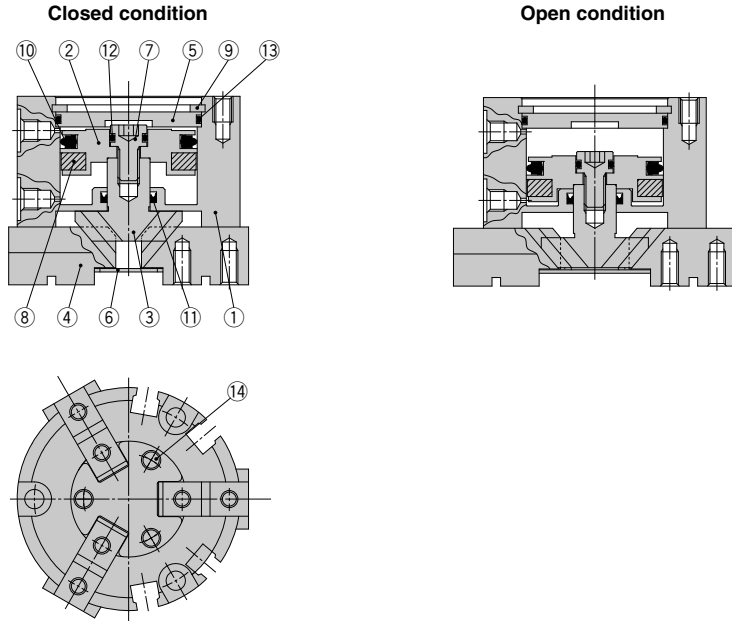

Component Parts

No.	Description	Material	Note
1	Body	Aluminum alloy	Hard anodized
2	Piston	Aluminum alloy	Hard anodized
3	Cam	Carbon steel	Heat treated, Specially treated
4	Finger	Carbon steel	Heat treated, Specially treated
5	Cap	Aluminum alloy	Hard anodized
6	End plate	Stainless steel	
7	Piston bolt	Stainless steel	

No.	Description	Material	Note
8	Magnet	—	
9	Type C snap ring	Carbon steel	Phosphate coated
10	Piston seal	NBR	
11	Rod seal	NBR	
12	Gasket	NBR	
13	Gasket	NBR	
14	Cross recessed flat head screw	Carbon steel	Zinc chromated

Replacement Parts

Description	MHS3-16D	MHS3-20D	MHS3-25D	MHS3-32D	MHS3-40D	Main parts
Seal kit	MHS16-PS	MHS20-PS	MHS25-PS	MHS32-PS	MHS40-PS	⑩⑪⑫⑬
Finger	P3316004	P3316104	P3316204	P3316304	P3316404	④
Cam	P3316003	P3316103	P3316203	P3316303	P3316403	③
Piston assembly	MHS-A1601	MHS-A2001	MHS-A2501	MHS-A3201	MHS-A4001	②⑦⑧
End plate assembly	MHS-A1613-3	MHS-A2013-3	MHS-A2513-3	MHS-A3213-3	MHS-A4013-3	⑥⑭
Cap	MHS-A16014	MHS-A2014	MHS-A2514	MHS-A3214	MHS-A4014	⑤

Description	MHS3-50D	MHS3-63D	MHS3-80D	MHS3-100D	MHS3-125D	Main parts
Seal kit	MHS50-PS	MHS63-PS	MHS80-PS	MHS100-PS	MHS125-PS	⑩⑪⑫⑬
Finger	P3316504	P3316604	P3316704	P3316804	P3316904	④
Cam	P3316503	P3316603	P3316703	P3316803	P3316903	③
Piston assembly	MHS-A5001	MHS-A6301	MHS-A8001	MHS-A10001	MHS-A12501	②⑦⑧
End plate assembly	MHS-A5013-3	MHS-A6313-3	MHS-A8013-3	MHS-A10013-3	MHS-A12513-3	⑥⑭
Cap	MHS-A5014	MHS-A6314	MHS-A8014	MHS-A10014	MHS-A12514	⑤

* Order 3 pieces of fingers for one unit.

Replacement part/Grease pack part no.: MH-G01 (30 g)

Gripping Point

- The workpiece gripping point distance should be within the gripping force ranges given for each pressure in the effective gripping force graphs below.
- If operated with the workpiece gripping point beyond the indicated ranges, an excessive offset load will be applied to the sliding section of the fingers, which can have an adverse effect on the service life of the product.

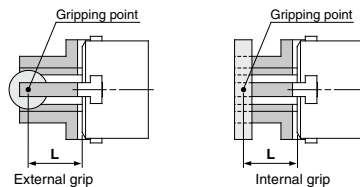

L: Gripping point distance

Effective Gripping Force

- Indication of effective gripping force
The effective gripping force shown in the graphs to the right is expressed as **F**, which is the thrust of one finger when all 3 of the fingers and attachments are in full contact with the workpiece as shown in the figure below.

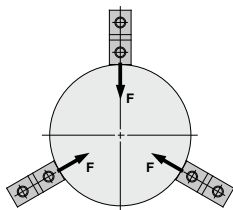

External grip

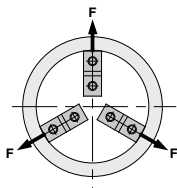

Internal grip

External Gripping Force

MHS3-16D

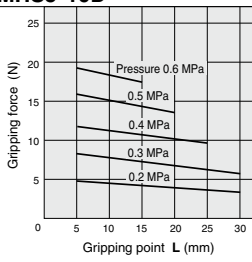

MHS3-20D

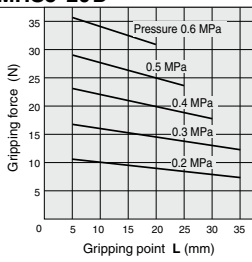

MHS3-25D

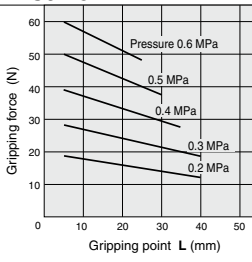

Internal Gripping Force

MHS3-16D

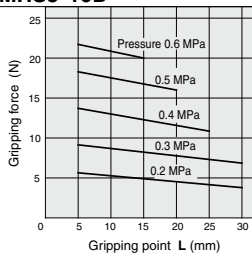

MHS3-20D

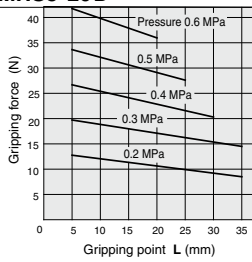

MHS3-25D

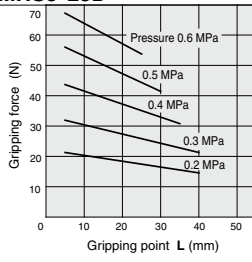

MHZ

MHF

MHL

MHR

MHK

MHS

MHC

MHT

MHY

MHW

-X

MRHQ

MA

D-

MHS3 Series

Effective Gripping Force

• Indication of effective gripping force

The effective gripping force shown in the graphs to the right is expressed as F , which is the thrust of one finger when all 3 of the fingers and attachments are in full contact with the workpiece as shown in the figure below.

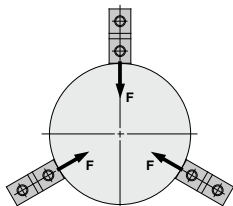

External grip

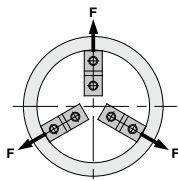

Internal grip

External Gripping Force

MHS3-32D

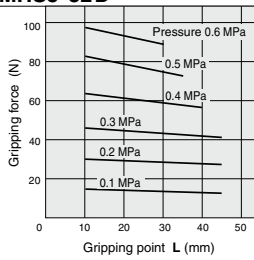

MHS3-40D

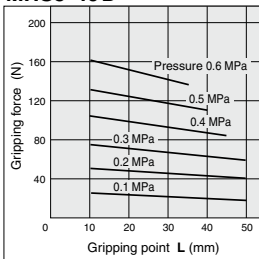

MHS3-50D

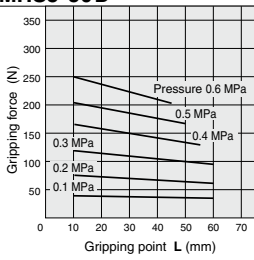

MHS3-63D

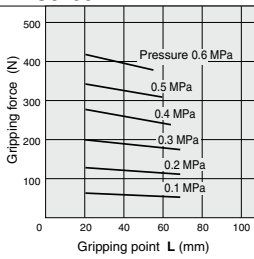

Internal Gripping Force

MHS3-32D

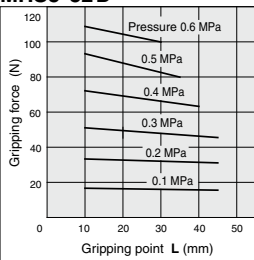

MHS3-40D

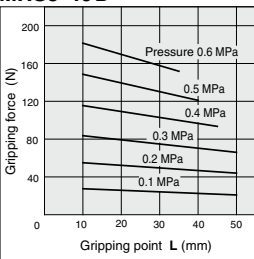

MHS3-50D

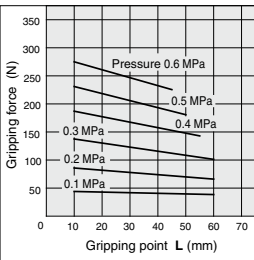

MHS3-63D

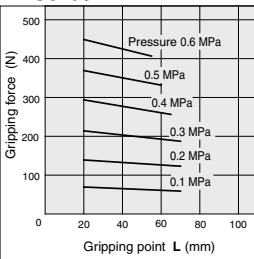

External Gripping Force

MHS3-80D

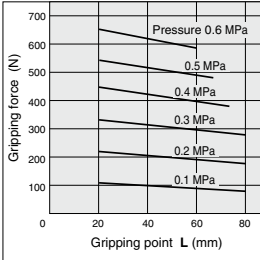

MHS3-100D

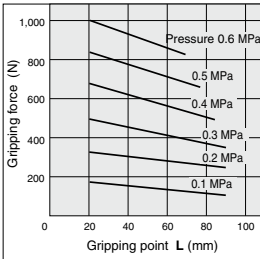

MHS3-125D

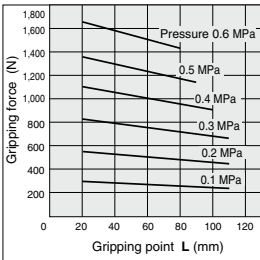

Internal Gripping Force

MHS3-80D

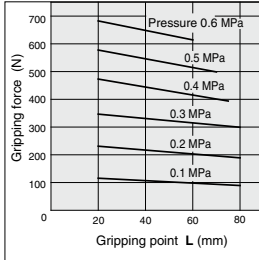

MHS3-100D

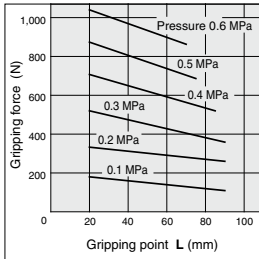

MHS3-125D

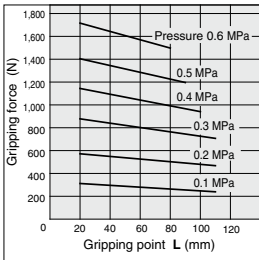

- MHZ
- MHF
- MHL
- MHR
- MHK
- MHS**
- MHC
- MHT
- MHY
- MHW
- X□
- MRHQ
- MA
- D-□

MHS3 Series

Dimensions

MHS3-16D to 25D

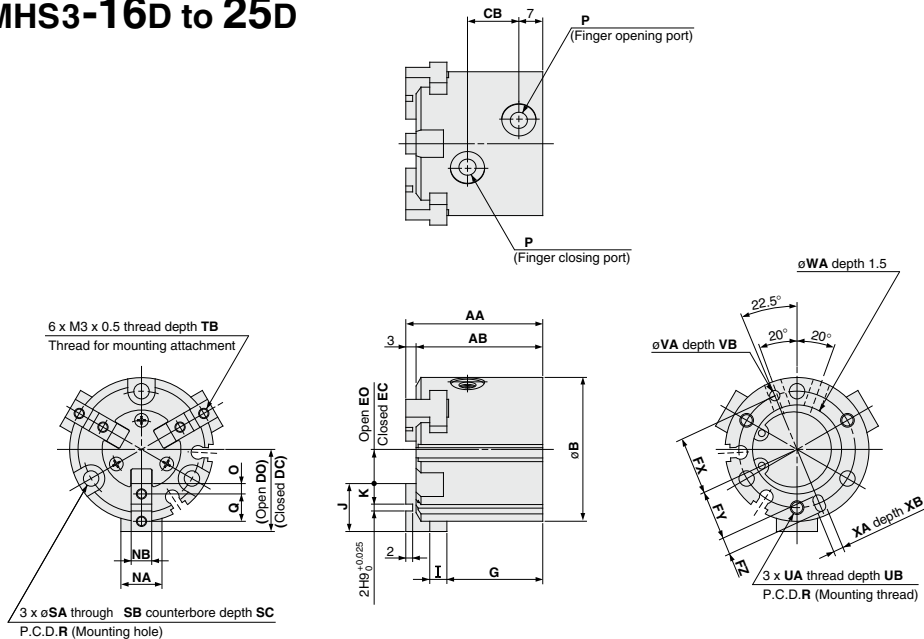

Auto switch mounting groove dimensions (2 locations)

MHS3-16D

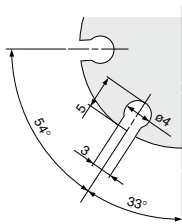

MHS3-20D

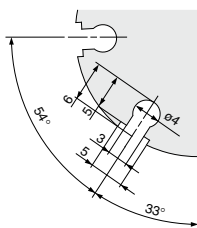

MHS3-25D

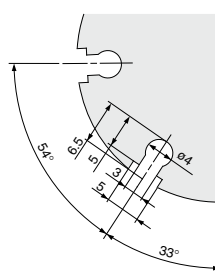

Model	AA	AB	B	CB	DC	DO	EC	EO	FX	FY	FZ	G	I	J	K	NA	NB	O	P	Q	R
MHS3-16D	35	32	30	11	15	17	5	7	12.5	11	3	25	4	10	4	8	5h9 _{-0.030}	2	M3 x 0.5	6	25
MHS3-20D	38	35	36	13	18	20	6	8	14.5	13	3	27	5	12	5	10	6h9 _{-0.030}	2.5	M5 x 0.8	7	29
MHS3-25D	40	37	42	15	21	24	7	10	17	14.5	5	28	5	14	6	12	6h9 _{-0.030}	3	M5 x 0.8	8	34

Model	SA	SB	SC	TB	UA	UB	VA	VB	WA	XA	XB
MHS3-16D	3.4	6.5	8	5	M3 x 0.5	4.5	2H9 ₀ ^{+0.025}	2	17H9 ₀ ^{+0.043}	2H9 ₀ ^{+0.025}	2
MHS3-20D	3.4	6.5	9.5	6	M3 x 0.5	6	2H9 ₀ ^{+0.025}	2	21H9 ₀ ^{+0.052}	2H9 ₀ ^{+0.025}	2
MHS3-25D	4.5	8	10	6	M4 x 0.7	6	3H9 ₀ ^{+0.025}	3	26H9 ₀ ^{+0.052}	3H9 ₀ ^{+0.025}	3

MHS3-32D to 80D

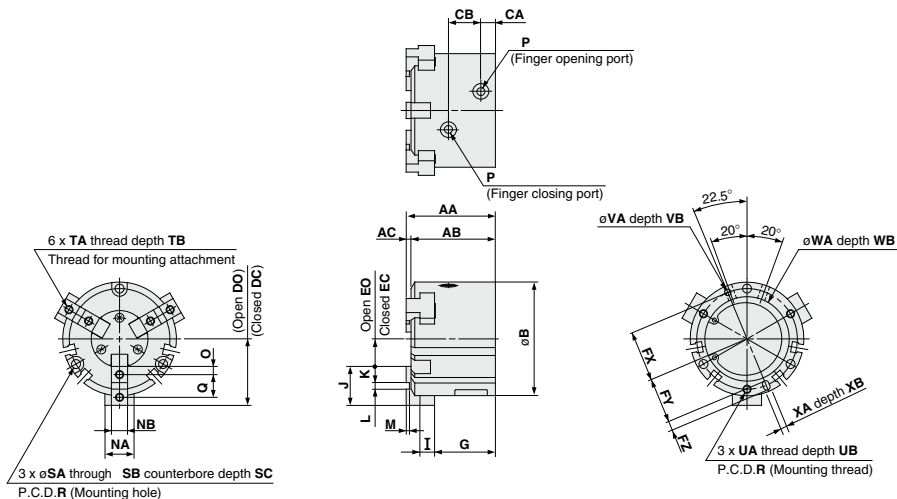

Auto switch mounting groove dimensions (4 locations)

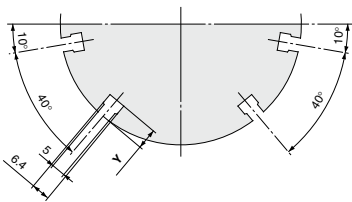

Model	AA	AB	AC	B	CA	CB	DC	DO	EC	EO	FX	FY	FZ	G	I	J	K	L	M	NA	NB	
MHS3-32D	44	41	3	52	8	16	28	32	8	12	22	19.5	5	30.5	6	20	9	2H9 ⁰ ₀	2	14	8H9 ⁰ ₀	0.036
MHS3-40D	47	44	3	62	9	17	31	35	10	14	26.5	23.5	6	32	7	21	9	3H9 ⁰ ₀	2	16	8H9 ⁰ ₀	-0.036
MHS3-50D	55	52	3	70	9	20	35	41	11	17	31	28	6	37.5	9	24	10	4H9 ⁰ ₀	2	18	10H9 ⁰ ₀	-0.036
MHS3-63D	66	62	4	86	12	22	43	51	15	23	38	34.5	7	44	11	28	11	6H9 ⁰ ₀	3	24	12H9 ⁰ ₀	-0.043
MHS3-80D	82	77	5	106	13.5	27	53.5	63.5	21.5	31.5	47.5	43.5	8	56	12	32	12	8H9 ⁰ ₀	4	28	14H9 ⁰ ₀	-0.043

Model	O	P	Q	R	SA	SB	SC	TA	TB	UA	UB	VA	VB	WA	WB	XA	XB	Y
MHS3-32D	4.5	M5 x 0.8	11	44	4.5	8	9	M4 x 0.7	8	M4 x 0.7	6	3H9 ^{+0.025} ₀	3	34H9 ^{+0.062} ₀	2	3H9 ^{+0.025} ₀	3	6
MHS3-40D	4.5	M5 x 0.8	12	53	5.5	9.5	9	M4 x 0.7	8	M5 x 0.8	7.5	4H9 ^{+0.030} ₀	4	42H9 ^{+0.062} ₀	2	4H9 ^{+0.030} ₀	4	8
MHS3-50D	5	M5 x 0.8	14	62	5.5	9.5	12	M5 x 0.8	10	M5 x 0.8	10	4H9 ^{+0.030} ₀	4	52H9 ^{+0.074} ₀	2	4H9 ^{+0.030} ₀	4	7
MHS3-63D	5.5	M5 x 0.8	17	76	6.6	11	14	M5 x 0.8	10	M6 x 1	9	5H9 ^{+0.030} ₀	5	65H9 ^{+0.074} ₀	2.5	5H9 ^{+0.030} ₀	5	7.5
MHS3-80D	6	REG 1/8 (G 1/8, NPT 1/8)	20	95	6.6	11	19	M6 x 1	12	M6 x 1	12	6H9 ^{+0.030} ₀	6	82H9 ^{+0.087} ₀	3	6H9 ^{+0.030} ₀	6	9

- MHZ
- MHF
- MHL
- MHR
- MHK
- MHS**
- MHC
- MHT
- MHY
- MHW
- X□
- MRHQ
- MA
- D-□

MHS3 Series

Dimensions

MHS3-100D/125D

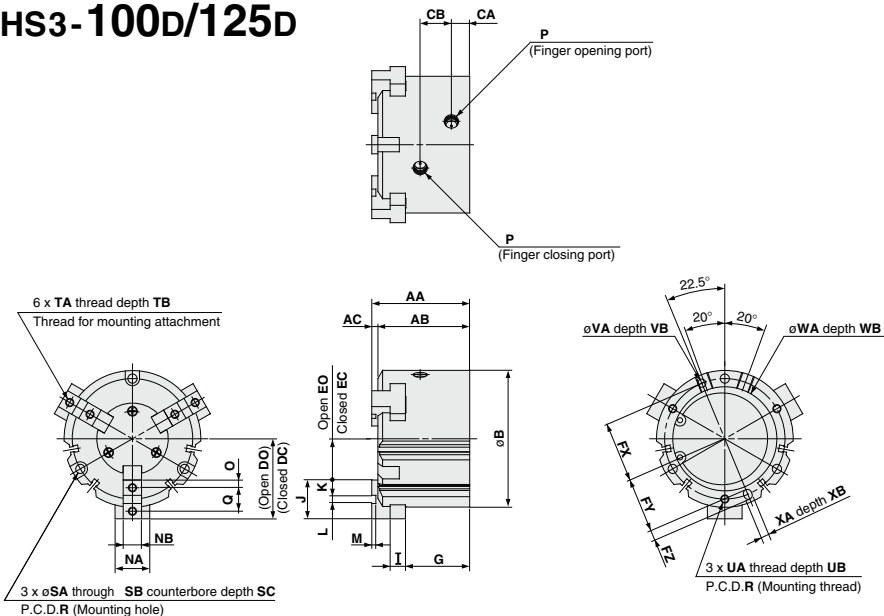

Auto switch mounting groove positions (4 locations)

MHS3-100D

MHS3-125D

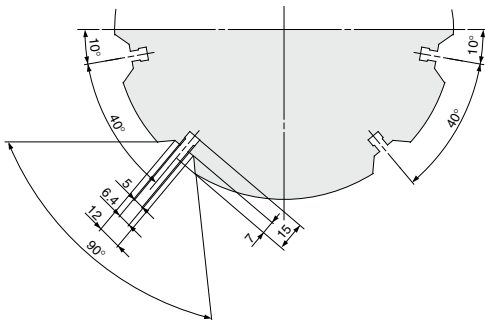
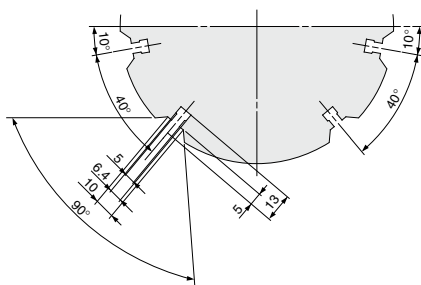

Model	AA	AB	AC	B	CA	CB	DC	DO	EC	EO	FX	FY	FZ	G	I	J	K	L	M	NA	NB
MHS3-100D	96	90	6	134	18	30.6	66	78	28	40	59	54	10	63	15	38	15	8H9 ₀ ^{+0.036}	4	34	18H9 ₀ ^{+0.043}
MHS3-125D	122	114	8	166	23.5	38	82	98	30	46	74	68	12	84	18	52	21	10H9 ₀ ^{+0.036}	6	40	22H9 ₀ ^{+0.052}

Model	O	P	Q	R	SA	SB	SC	TA	TB	UA	UB	VA	VB	WA	WB	XA	XB
MHS3-100D	7.5	Rc 1/4 (G 1/4, NPT 1/4)	23	118	9	14	21	M8 x 1.25	16	M8 x 1.25	16	8H9 ₀ ^{+0.036}	6	102H9 ₀ ^{+0.067}	4	8H9 ₀ ^{+0.036}	6
MHS3-125D	10.5	Rc 3/8 (G 3/8, NPT 3/8)	31	148	11	17.5	34	M10 x 1.5	20	M10 x 1.5	20	10H9 ₀ ^{+0.036}	8	130H9 ₀ ^{+0.100}	6	10H9 ₀ ^{+0.036}	8

MHS3 Series Detailed Dimensions of Mounting Portion of End Plate

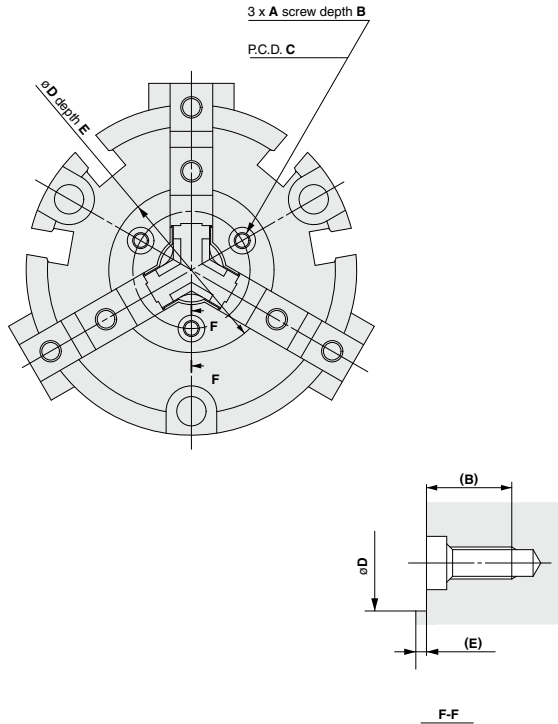

Model	A	B	C	øD	E
MHS3-16D	M2 x 0.4	5.5	12.5	18H8 ^{+0.027} ₀	0.5
MHS3-20D		5.4	15	21H8 ^{+0.033} ₀	0.6
MHS3-25D			17	23H8 ^{+0.033} ₀	
MHS3-32D		5.2	21	27H8 ^{+0.033} ₀	0.8
MHS3-40D	M3 x 0.5	8	22	31H8 ^{+0.039} ₀	1
MHS3-50D			26	35H8 ^{+0.039} ₀	
MHS3-63D			33	42H8 ^{+0.039} ₀	
MHS3-80D			40	52H8 ^{+0.046} ₀	
MHS3-100D	M4 x 0.7	9.5	54	70H8 ^{+0.046} ₀	1.5
MHS3-125D			62	82H8 ^{+0.054} ₀	

- MHZ
- MHF
- MHL
- MHR
- MHK
- MHS**
- MHC
- MHT
- MHY
- MHW
- X□
- MRHQ
- MA
- D-□

Parallel Type Air Gripper 3-Finger Type with Dust Cover

MHSJ3 Series

ø16, ø20, ø25, ø32, ø40, ø50, ø63, ø80

How to Order

MHSJ 3 - 32 [] D [] - M9BW [] - []

With dust cover •

Number of fingers •
3 3 fingers

Bore size •

16	16 mm
20	20 mm
25	25 mm
32	32 mm
40	40 mm
50	50 mm
63	63 mm
80	80 mm

Auto switch •

Nil	Without auto switch (Built-in magnet)
-----	---------------------------------------

* For the applicable auto switch model, refer to the table below.

Dust cover type

Nil	Chloroprene rubber (CR)
F	Fluororubber (FKM)
S	Silicone rubber

Port thread type •

Symbol	Type	Cylinder bore
Nil	M thread	ø16 to ø63
	Rc	
TN	NPT	ø80
TF	G	

Action

D	Double acting
---	---------------

Made to Order
Refer to page 595 for details.

Number of auto switches

Nil	2 pcs.
S	1 pc.

Applicable Auto Switches/Refer to pages 797 to 850 for further information on auto switches.

Type	Special function	Electrical entry	Indicator light	Wiring (Output)	Load voltage		Auto switch model		Lead wire length (m)*			Pre-wired connector	Applicable load	
					DC	AC	Perpendicular	In-line	0.5 (Nil)	1 (M)	3 (L)			5 (Z)
Solid state auto switch	—	Grommet	Yes	3-wire (NPN)	24 V	—	M9NV	M9N	●	●	○	○	IC circuit	
				3-wire (PNP)			M9PV	M9P	●	●	○	○		
				2-wire			M9BV	M9B	●	●	○	○		
				3-wire (NPN)			M9NVW	M9NW	●	●	○	○		IC circuit
				3-wire (PNP)			M9PWV	M9PW	●	●	○	○		
				2-wire			M9BWW	M9BW	●	●	○	○		—
	Water resistant (2-color indicator)	Grommet	Yes	3-wire (NPN)	24 V	—	M9NAV**	M9NA**	○	○	●	○	○	IC circuit
				3-wire (PNP)			M9PAV**	M9PA**	○	○	○	○		
				2-wire			M9BAV**	M9BA**	○	○	○	○	—	

** Water resistant type auto switches can be mounted on the above models, but in such case SMC cannot guarantee water resistance.

* Lead wire length symbols: 0.5 m Nil (Example) M9NW
1 m M (Example) M9NWL
3 m L (Example) M9NWL
5 m Z (Example) M9NWZ

* Auto switches marked with a "○" symbol are produced upon receipt of order.

Note) When using the 2-color indicator type, please make the setting so that the indicator is lit in red to ensure the detection at the proper position of the air gripper.

Parallel Type Air Gripper 3-Finger Type with Dust Cover **MHSJ3 Series**

Models/Specifications



Model	MHSJ3-16D	MHSJ3-20D	MHSJ3-25D	MHSJ3-32D	MHSJ3-40D	MHSJ3-50D	MHSJ3-63D	MHSJ3-80D	
Cylinder bore size (mm)	16	20	25	32	40	50	63	80	
Fluid	Air								
Operating pressure (MPa)	0.2 to 0.6			0.1 to 0.6					
Ambient and fluid temperature (°C)	-10 to 60								
Repeatability (mm)	±0.01								
Max. operating frequency (c.p.m.)	120			60				30	
Lubrication	Not required								
Action	Double acting								
Effective gripping force (N) at 0.5 MPa^{Note 1)}	External grip	9	21	36	62	97	155	280	400
	Internal grip	16	28	47	82	130	204	359	525
Opening/Closing stroke (mm) (dia.)	4	4	6	8	8	12	16	20	
Weight (g)	95	150	230	440	620	1,050	1,800	3,200	

Note 1) Values for $\phi 16$ to $\phi 25$ are with gripping point $L = 20$ mm, for $\phi 32$ to $\phi 63$ with gripping point $L = 30$ mm, and for $\phi 80$ with gripping point $L = 50$ mm. Refer to "Effective Gripping Force" data on pages 597 to 599 for the gripping force at each gripping position.

Symbol

Double acting:
Internal grip

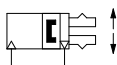

Double acting:
External grip

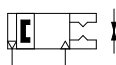

Made to Order
[Click here for details](#)

Symbol	Specifications/Description
-X4	Heat resistance (100°C)
-X5	Fluororubber seal
-X50	Without magnet
-X53	EPDM seal/Fluorine grease
-X56	Axial ported
-X63	Fluorine grease
-X77A	Dust cover adhesion
-X77B	Dust cover adhesion (Finger part only)
-X78A	Dust cover caulking
-X78B	Dust cover caulking (Finger part only)
-X79	Grease for food processing machines, Fluorine grease
-X79A	Grease for food processing machines

Refer to pages 636 to 643 for the specifications of products with auto switches.

- Auto switch installation examples and mounting positions
- Auto switch hysteresis
- Auto switch mounting
- Protrusion of auto switch from edge of body

MHZ

MHF

MHL

MHR

MHK

MHS

MHC

MHT

MHY

MHW

-X□

MRHQ

MA

D-□

MHSJ3 Series

Construction

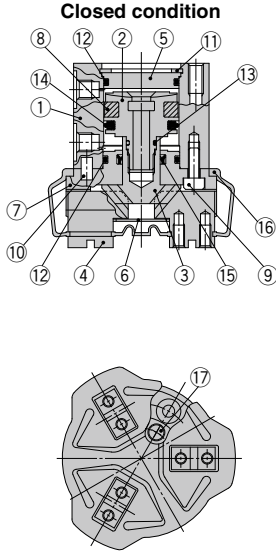

ø16 to ø25 Open condition

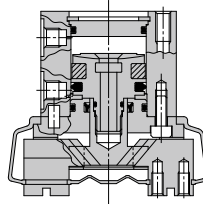

ø32 to ø80 Open condition

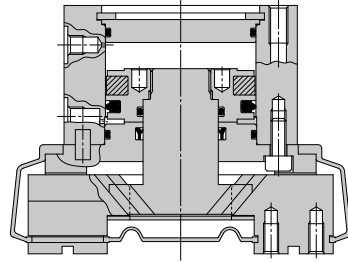

Component Parts

No.	Description	Material	Note
1	Body	Aluminum alloy	Hard anodized
2	Piston	ø16 to ø25: Stainless steel ø32 to ø80: Aluminum alloy	Hard anodized
3	Cam	Carbon steel	Heat treated, Specially treated
4	Finger	Carbon steel	Heat treated, Specially treated
5	Cap	Aluminum alloy	Hard anodized
6	End plate	Stainless steel	
7	Guide	Aluminum alloy	Hard anodized
8	Magnet	—	

No.	Description	Material	Note
9	Hexagon socket head bolt	Carbon steel	Zinc chromated
10	Parallel pin	Stainless steel	
11	Type C retaining ring	Carbon steel	Nickel plated
12	Gasket	NBR	
13	Gasket	NBR	
14	Piston seal	NBR	
15	Rod seal	NBR	
16	Dust cover	CR/FKM/Si	
17	Cross recessed flat head screw	Carbon steel	Zinc chromated

Replacement Parts

Description		MHSJ3-16D	MHSJ3-20D	MHSJ3-25D	MHSJ3-32D	Main parts
Seal kit		MHSJ16-PS	MHSJ20-PS	MHSJ25-PS	MHSJ32-PS	(2)(3)(14)(15)
Dust cover	Material	CR	MHSJ3-J16	MHSJ3-J20	MHSJ3-J25	(16)
		FKM	MHSJ3-J16F	MHSJ3-J20F	MHSJ3-J25F	
		Silicone rubber	MHSJ3-J16S	MHSJ3-J20S	MHSJ3-J25S	
Finger		P3316054	P3316154	P3316254	P3316354	(4)
Cam (J)		P3316093	P3316193	P3316293	P3316393	(3)
Piston assembly		MHS-A1603	MHS-A2003	MHS-A2503	MHS-A3203	(2)(8)
End plate assembly		MHSJ-A1613	MHSJ-A2013	MHSJ-A2513	MHSJ-A3213	(6)(17)
Cap		MHSJ-A1614	MHSJ-A2014	MHSJ-A2514	MHSJ-A3214	(5)

Description		MHSJ3-40D	MHSJ3-50D	MHSJ3-63D	MHSJ3-80D	Main parts
Seal kit		MHSJ40-PS	MHSJ50-PS	MHSJ63-PS	MHSJ80-PS	(2)(3)(14)(15)
Dust cover	Material	CR	MHSJ3-J40	MHSJ3-J50	MHSJ3-J63	(16)
		FKM	MHSJ3-J40F	MHSJ3-J50F	MHSJ3-J63F	
		Silicone rubber	MHSJ3-J40S	MHSJ3-J50S	MHSJ3-J63S	
Finger		P3316454	P3316554	P3316654	P3316754	(4)
Cam (J)		P3316493	P3316593	P3316693	P3316793	(3)
Piston assembly		MHS-A4003	MHS-A5003	MHS-A6303	MHS-A8003	(2)(8)
End plate assembly		MHSJ-A4013	MHSJ-A5013	MHSJ-A6313	MHSJ-A8013	(6)(17)
Cap		MHSJ-A4014	MHSJ-A5014	MHSJ-A6314	MHSJ-A8014	(5)

* Order 3 pieces of fingers for one unit.

Replacement part/Grease pack part no.: MH-G01 (30 g)

Gripping Point

- The workpiece gripping point distance should be within the gripping force ranges given for each pressure in the effective gripping force graphs below.
- If operated with the workpiece gripping point beyond the indicated ranges, an excessive offset load will be applied to the sliding section of the fingers, which can have an adverse effect on the service life of the product.

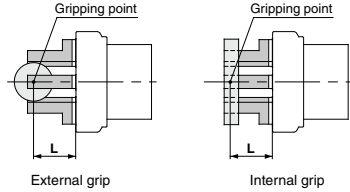

L: Gripping point distance

Effective Gripping Force

- Indication of effective gripping force
The effective gripping force shown in the graphs to the right is expressed as F , which is the thrust of one finger when all 3 of the fingers and attachments are in full contact with the workpiece as shown in the figure below.

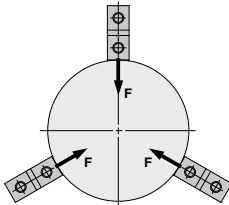

External grip

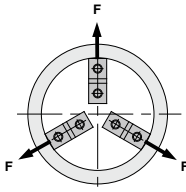

Internal grip

External Gripping Force

MHSJ3-16D

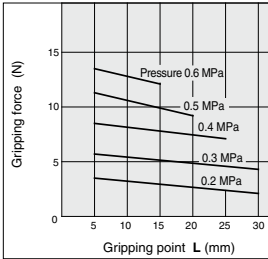

MHSJ3-20D

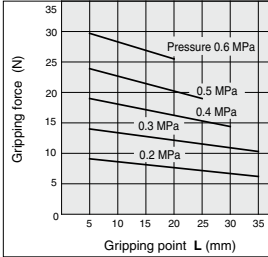

MHSJ3-25D

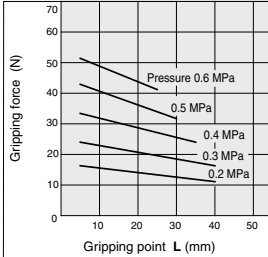

Internal Gripping Force

MHSJ3-16D

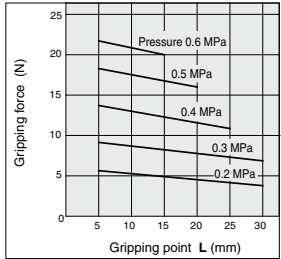

MHSJ3-20D

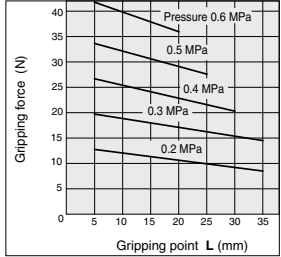

MHSJ3-25D

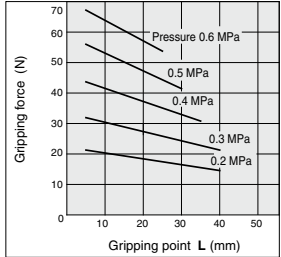

MHZ

MHF

MHL

MHR

MHK

MHS

MHC

MHT

MHY

MHW

-X

MRHQ

MA

D-

MHSJ3 Series

Effective Gripping Force

• Indication of effective gripping force

The effective gripping force shown in the graphs to the right is expressed as F , which is the thrust of one finger when all 3 of the fingers and attachments are in full contact with the workpiece as shown in the figure below.

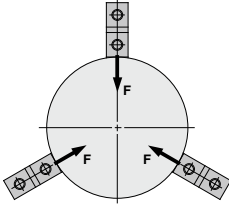

External grip

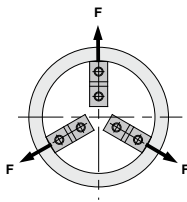

Internal grip

External Gripping Force

MHSJ3-32D

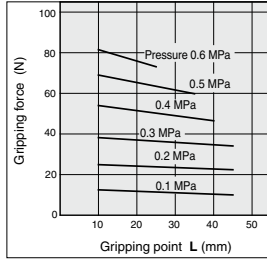

MHSJ3-40D

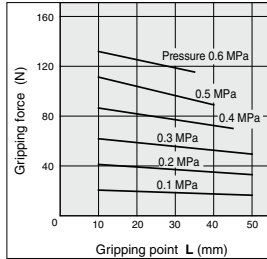

MHSJ3-50D

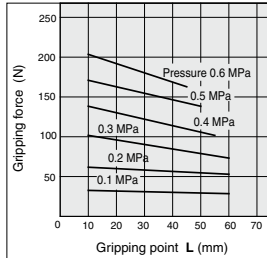

MHSJ3-63D

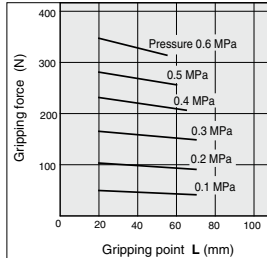

Internal Gripping Force

MHSJ3-32D

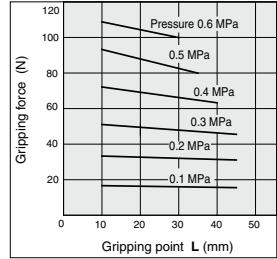

MHSJ3-40D

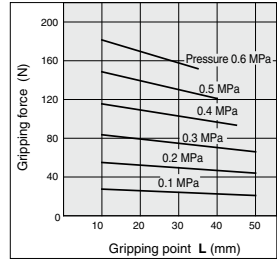

MHSJ3-50D

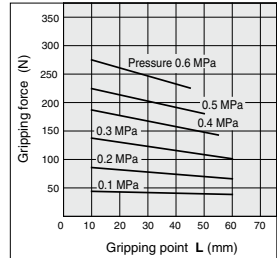

MHSJ3-63D

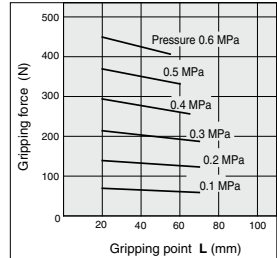

External Gripping Force

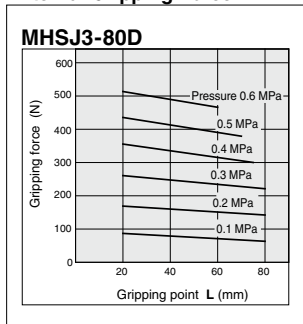

Internal Gripping Force

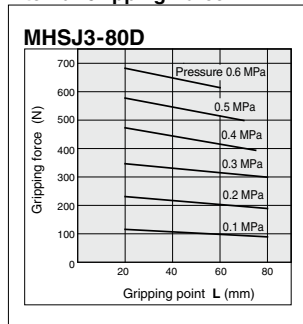

- MHZ
- MHF
- MHL
- MHR
- MHK
- MHS**
- MHC
- MHT
- MHY
- MHW
- X□
- MRHQ
- MA
- D-□

MHSJ3 Series

Dimensions

MHSJ3-16D to 25D

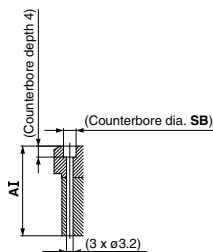
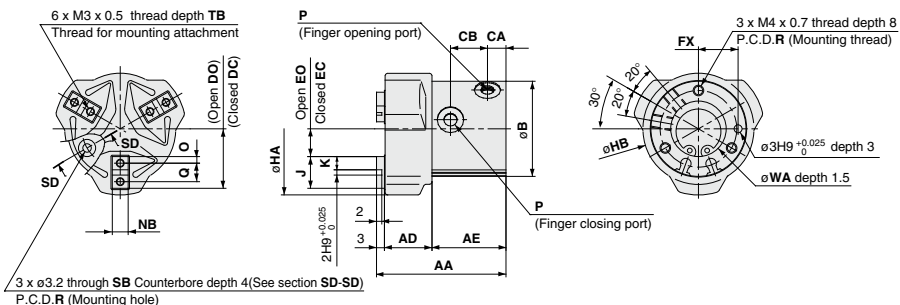

Section SD - SD

Auto switch mounting groove dimensions (2 locations)

MHSJ3-16D

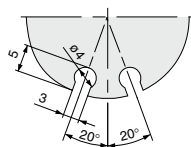

MHSJ3-20D

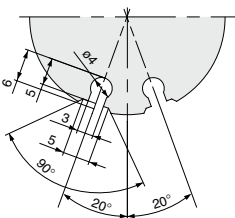

MHSJ3-25D

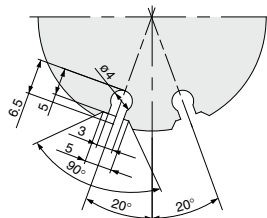

Model	AA	AD	AE	AI	B	CA	CB	DC	DO	EC	EO	FX	HA	HB	J	K	NB	O	P	Q
MHSJ3-16D	46	16	27	39	30	7	14	17.5	19.5	7.5	9.5	12	46	36	10	4	5h9 $\frac{0}{0.030}$	2	M3 x 0.5	6
MHSJ3-20D	49	18	28	42	36	7	14	20	22	8	10	15	52	42	12	5	6h9 $\frac{0}{0.030}$	2.5	M5 x 0.8	7
MHSJ3-25D	55	20	32	47	42	7.5	17.5	23.5	26.5	9.5	12.5	18	62	50	14	6	6h9 $\frac{0}{0.030}$	3	M5 x 0.8	8

(mm)

Model	R	SB	TB	WA
MHSJ3-16D	24	6	5	17H9 $\frac{+0.043}{0}$
MHSJ3-20D	29	6.5	6	21H9 $\frac{+0.052}{0}$
MHSJ3-25D	34	6.5	6	26H9 $\frac{+0.052}{0}$

MHSJ3-32D to 80D

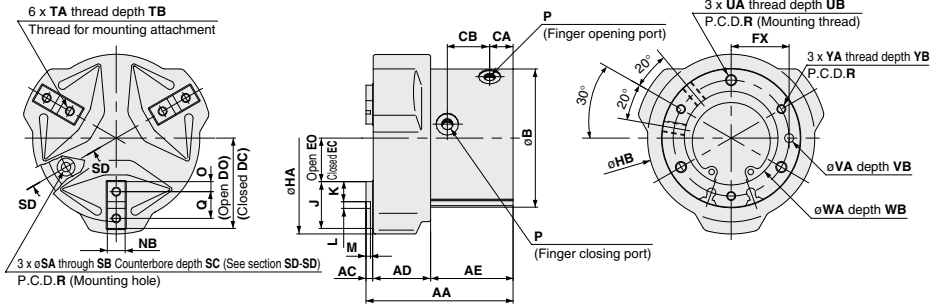

Auto switch mounting groove dimensions (2 locations)

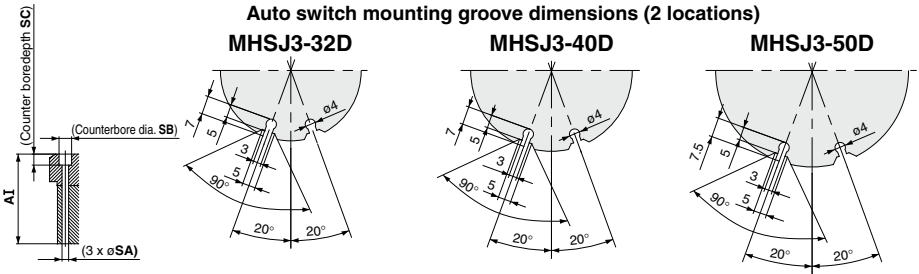

Section SD - SD

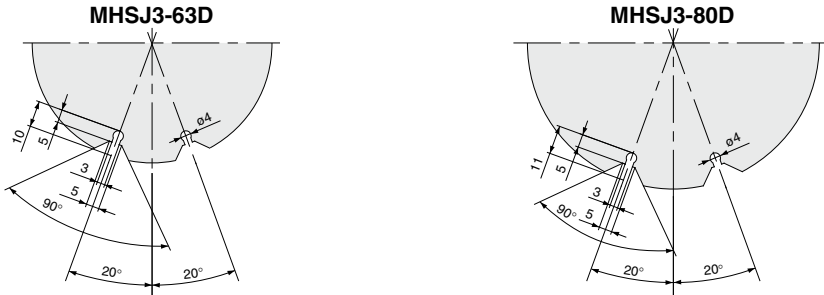

Model	AA	AC	AD	AE	AI	B	CA	CB	DC	DO	EC	EO	FX	HA	HB	J	K	L	M	NB
MHSJ3-32D	63	3	24	36	54	54	9.5	19	31.5	35.5	11.5	15.5	22	80	65	20	9	2H9 ^{+0.025} ₀	2	8h9 ⁰ _{-0.036}
MHSJ3-40D	66	3	26	37	57	62	10.5	19	36	40	15	19	26	90	75	21	9	3H9 ^{+0.035} ₀	2	8h9 ⁰ _{-0.036}
MHSJ3-50D	80	3	31	46	70	74	11.5	26.5	42	48	18	24	32	109	88	24	10	4H9 ^{+0.030} ₀	2	10h9 ⁰ _{-0.036}
MHSJ3-63D	91	4	37	50	79	92	13	28	51	59	23	31	40	133	106	28	11	6H9 ^{+0.030} ₀	3	12h9 ⁰ _{-0.043}
MHSJ3-80D	108	5	46	57	93	112	14	31	63	73	31	41	50	168	130	32	12	8H9 ^{+0.036} ₀	4	14h9 ⁰ _{-0.043}

Model	O	P	Q	R	SA	SB	SC	TA	TB	UA	UB	VA	VB	WA	WB	YA	YB
MHSJ3-32D	4.5	M5 x 0.8	11	44	4.2	8	7	M4 x 0.7	8	M5 x 0.8	10	4H9 ^{+0.030} ₀	4	34H9 ^{+0.062} ₀	2	M4 x 0.7	8
MHSJ3-40D	4.5	M5 x 0.8	12	52	4.2	8	7	M4 x 0.7	8	M5 x 0.8	10	4H9 ^{+0.030} ₀	4	42H9 ^{+0.062} ₀	2	M4 x 0.7	8
MHSJ3-50D	5	M5 x 0.8	14	63	5.1	9.5	8	M5 x 0.8	10	M6 x 1	12	5H9 ^{+0.030} ₀	5	52H9 ^{+0.074} ₀	2	M5 x 0.8	10
MHSJ3-63D	5.5	M5 x 0.8	17	78	6.6	11	8	M5 x 0.8	10	M8 x 1.25	16	6H9 ^{+0.030} ₀	6	65H9 ^{+0.074} ₀	2.5	M6 x 1	12
MHSJ3-80D	6	M6 x 1	20	98	6.6	11	8	M6 x 1	12	M8 x 1.25	16	6H9 ^{+0.030} ₀	6	82H9 ^{+0.087} ₀	3	M6 x 1	12

- MHZ
- MHF
- MHL
- MHR
- MHK
- MHS**
- MHC
- MHT
- MHY
- MHW
- X□
- MRHQ
- MA
- D-□

Parallel Type Air Gripper 3-Finger Type Through-hole Type

MHSH3 Series

ø16, ø20, ø25, ø32, ø40, ø50, ø63, ø80

How to Order

MHSH 3 - 32 D - M9BW

Through-hole

Dust cover

Nil	None
J	With dust cover

Note) ø16, ø20 and ø25 are not available with dust cover.

Number of fingers

3 3 fingers

Port thread type

Symbol	Type	Cylinder bore
Nil	M thread	ø16 to ø63
TN	NPT	ø80
TF	G	

Bore size

16	16 mm	40	40 mm
20	20 mm	50	50 mm
25	25 mm	63	63 mm
32	32 mm	80	80 mm

Center pusher

Nil	Without center pusher
A	Cylinder type
B	Spring type

Note) ø16, ø20 and ø25 are not available with center pusher.

Dust cover type (with dust cover only)

Nil	Chloroprene rubber (CR)
F	Fluororubber (FKM)
S	Silicone rubber

Number of auto switches

Nil	2 pcs.
S	1 pc.
n (Note)	"n" pcs.

Made to Order Refer to page 603 for details.

Note) Symbol entry examples when mounting auto switches on air gripper with cylinder type center pusher

- Air gripper unit 1 pc. } Total of 2 pcs. → Nil
Center pusher unit 1 pc. } MHSH3-32DA-M9N
- Air gripper unit 2 pcs. } Total of 4 pcs. → Enter "4"
Center pusher unit 2 pcs. } MHSH3-32DA-M9N4

Action

D Double acting

Applicable Auto Switches /Refer to pages 797 to 850 for further information on auto switches.

* For the applicable auto switch model, refer to the table below.

Type	Special function	Electrical entry	Indicator light	Wiring (Output)	Load voltage		Auto switch model		Lead wire length (m)*				Pre-wired connector	Applicable load
					DC	AC	Perpendicular	In-line	0.5 (Nil)	1 (M)	3 (L)	5 (Z)		
Solid state auto switch	—	Grommet	Yes	3-wire (NPN)	24 V	—	M9NV	M9N	●	●	●	○	○	IC circuit
				3-wire (PNP)			M9PV	M9P	●	●	●	○	○	
				2-wire			M9BV	M9B	●	●	●	○	○	
				3-wire (NPN)			M9NWW	M9NWL	●	●	●	○	○	
				3-wire (PNP)			M9PWW	M9PW	●	●	●	○	○	
				2-wire			M9BWW	M9BW	●	●	●	○	○	
	Diagnostic (2-color indicator)	Grommet	Yes	3-wire (NPN)	24 V	—	M9NAV**	M9NA**	○	○	●	○	○	IC circuit
				3-wire (PNP)			M9PAV**	M9PA**	○	○	●	○	○	
				2-wire			M9BAV**	M9BA**	○	○	●	○	○	
				3-wire (NPN)			M9NVA**	M9NA**	○	○	●	○	○	
				3-wire (PNP)			M9PAV**	M9PA**	○	○	●	○	○	
				2-wire			M9BAV**	M9BA**	○	○	●	○	○	
Water resistant (2-color indicator)	Grommet	Yes	3-wire (NPN)	24 V	—	M9NV	M9N	●	●	●	○	○	IC circuit	
			3-wire (PNP)			M9PV	M9P	●	●	●	○	○		
			2-wire			M9BV	M9B	●	●	●	○	○		
			3-wire (NPN)			M9NWW	M9NWL	●	●	●	○	○		
			3-wire (PNP)			M9PWW	M9PW	●	●	●	○	○		
			2-wire			M9BWW	M9BW	●	●	●	○	○		

** Water resistant type auto switches can be mounted on the above models, but in such case SMC cannot guarantee water resistance.

* Lead wire length symbols: 0.5 m Nil (Example) M9NW

1 m M (Example) M9NWM

3 m L (Example) M9NWL

5 m Z (Example) M9NWZ

* Auto switches marked with a "O" symbol are produced upon receipt of order.

Note) When using the 2-color indicator type, please make the setting so that the indicator is lit in red to ensure the detection at the proper position of the air gripper.

Center pusher assembly

MHSH 3 - A 50 A - M9BW

Through-hole

Number of fingers

3 3 fingers

Bore size

32	32 mm
40	40 mm
50	50 mm
63	63 mm
80	80 mm

Center pusher assembly

Center pusher

A	Cylinder type
B	Spring type

Number of auto switches

Nil	2 pcs.
S	1 pc.

Auto switch (Cylinder type only)

Nil	Without auto switch (Built-in magnet)
-----	---------------------------------------

Made to Order Refer to page 603 for details.

* For the applicable auto switch model, refer to the table below.

Applicable Auto Switches /Refer to pages 797 to 850 for further information on auto switches.

Type	Special function	Electrical entry	Indicator light	Wiring (Output)	Load voltage		Auto switch model		Lead wire length (m)*				Pre-wired connector	Applicable load
					DC	AC	Perpendicular	In-line	0.5 (Nil)	1 (M)	3 (L)	5 (Z)		
Solid state auto switch	—	Grommet	Yes	3-wire (NPN)	24 V	—	M9NV	M9N	●	●	●	○	○	IC circuit
				3-wire (PNP)			M9PV	M9P	●	●	●	○	○	
				2-wire			M9BV	M9B	●	●	●	○	○	
				3-wire (NPN)			M9NWW	M9NWL	●	●	●	○	○	
				3-wire (PNP)			M9PWW	M9PW	●	●	●	○	○	
				2-wire			M9BWW	M9BW	●	●	●	○	○	
	Diagnostic (2-color indicator)	Grommet	Yes	3-wire (NPN)	24 V	—	M9NAV**	M9NA**	○	○	●	○	○	IC circuit
				3-wire (PNP)			M9PAV**	M9PA**	○	○	●	○	○	
				2-wire			M9BAV**	M9BA**	○	○	●	○	○	
				3-wire (NPN)			M9NVA**	M9NA**	○	○	●	○	○	
				3-wire (PNP)			M9PAV**	M9PA**	○	○	●	○	○	
				2-wire			M9BAV**	M9BA**	○	○	●	○	○	
Water resistant (2-color indicator)	Grommet	Yes	3-wire (NPN)	24 V	—	M9NV	M9N	●	●	●	○	○	IC circuit	
			3-wire (PNP)			M9PV	M9P	●	●	●	○	○		
			2-wire			M9BV	M9B	●	●	●	○	○		
			3-wire (NPN)			M9NWW	M9NWL	●	●	●	○	○		
			3-wire (PNP)			M9PWW	M9PW	●	●	●	○	○		
			2-wire			M9BWW	M9BW	●	●	●	○	○		

** Water resistant type auto switches can be mounted on the above models, but in such case SMC cannot guarantee water resistance.

* Lead wire length symbols: 0.5 m Nil (Example) M9NW

1 m M (Example) M9NWM

3 m L (Example) M9NWL

5 m Z (Example) M9NWZ

* Auto switches marked with a "O" symbol are produced upon receipt of order.

Note) When using the 2-color indicator type, please make the setting so that the indicator is lit in red to ensure the detection at the proper position of the air gripper.

Model/Specifications

Without center pusher



Center pusher/Cylinder type



Center pusher/Spring type



Air Gripper Specifications

Model	MHSH3-16D	MHSH3-20D	MHSH3-25D	MHSH3-32D	MHSH3-40D	MHSH3-50D	MHSH3-63D	MHSH3-80D	
Cylinder bore size (mm)	16	20	25	32	40	50	63	80	
Fluid	Air								
Operating pressure (MPa)	0.2 to 0.6			0.1 to 0.6					
Ambient and fluid temperature (°C)	- 10 to 60								
Repeatability (mm)	±0.01								
Max. operating frequency (c.p.m.)	120			60			30		
Lubrication	Not required								
Action	Double acting								
Effective gripping force (N) ^(note 1) at 0.5 MPa	External hold	9	21	36	62	97	155	280	400
	Internal hold	15	26	45	77	118	187	329	490
Through hole diameter (mm)	ø3H10 ^{+0.040} ₀	ø3H10 ^{+0.040} ₀	ø4H10 ^{+0.048} ₀	ø6H10 ^{+0.048} ₀	ø10H10 ^{+0.058} ₀	ø12H10 ^{+0.070} ₀	ø16H10 ^{+0.070} ₀	ø20H10 ^{+0.084} ₀	
Opening/Closing stroke (dia.) (mm)	4	4	6	8	8	12	16	20	
Weight (g)	90	140	220	410	570	970	1,650	2,920	

Note 1) Values for ø16 to ø25 are with gripping point L = 20 mm, for ø32 to ø63 with gripping point L = 30 mm, and for ø80 with gripping point L = 50 mm.
Refer to "Effective Gripping Force" data on pages 606 to 609 for the gripping force at each gripping position.

Symbol

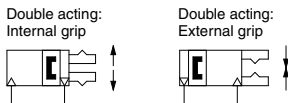

Made to Order
[Click here for details](#)

Symbol	Specifications/Description
-X4	Heat resistance (100°C)
-X5	Fluororubber seal
-X50	Without magnet
-X53	EPDM seal/Fluorine grease
-X56	Axial ported
-X63	Fluorine grease
-X77A	Dust cover adhesion
-X77B	Dust cover adhesion (Finger part only)
-X78A	Dust cover caulking
-X78B	Dust cover caulking (Finger part only)
-X79	Grease for food processing machines, Fluorine grease
-X79A	Grease for food processing machines

Refer to pages 636 to 643 for the specifications of products with auto switches.

- Auto switch installation examples and mounting positions
- Auto switch hysteresis
- Auto switch mounting
- Protrusion of auto switch from edge of body

Center Pusher (Cylinder type) Specifications

Model	MHSH3-32DA	MHSH3-40DA	MHSH3-50DA	MHSH3-63DA	MHSH3-80DA	
Pusher cylinder bore size (mm)	12	20	25	32	40	
Fluid	Air					
Operating pressure (MPa)	0.2 to 0.6		0.1 to 0.6			
Ambient and fluid temperature (°C)	- 10 to 60					
Pusher maximum operating frequency (c.p.m.)	60			30		
Lubrication	Not required					
Action	Double acting					
Pusher stroke (mm)	5	5	10	10	15	
Pusher thrust (N) at 0.5 MPa	Extention	45	130	204	335	524
		Weight (g)	530	770	1,330	2,300

Center Pusher (Spring type) Specifications

Model	MHSH3-32DB	MHSH3-40DB	MHSH3-50DB	MHSH3-63DB	MHSH3-80DB
Pusher stroke (mm)	5	5	10	10	15
Pusher spring force (N)	6 to 10	11 to 15	20 to 25	29 to 34	49 to 59
Weight (g)	500	740	1,290	2,250	4,000

Weight

	ø32	ø40	ø50	ø63	ø80
Through-hole with dust cover MHSHJ3-□D	430	600	1,020	1,710	3,040
Center pusher (cylinder type) with dust cover MHSHJ3-□DA	550	800	1,380	2,360	4,120
Center pusher (spring type) with dust cover MHSHJ3-□DB	520	770	1,340	2,310	4,120

MHZ

MHF

MHL

MHR

MHK

MHS

MHC

MHT

MHY

MHW

-X□

MRHQ

MA

D-□

MHSH3 Series

Construction

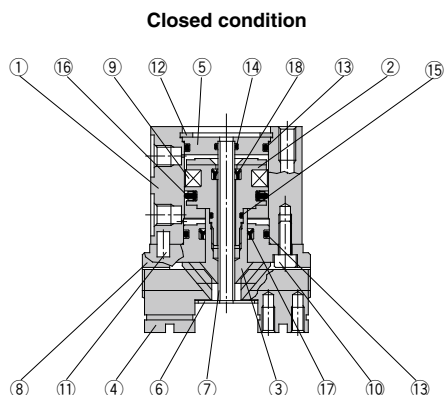

ø16 to ø25 Open condition

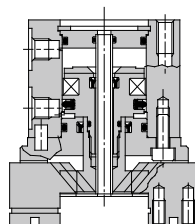

ø32 to ø80 Open condition

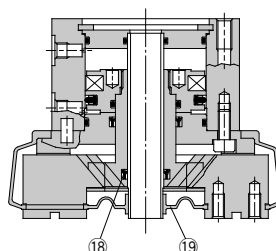

Component Parts

No.	Description	Material	Note
1	Body	Aluminum alloy	Hard anodized
2	Piston	ø16 to ø25: Stainless steel ø32 to ø80: Aluminum alloy	Hard anodized
3	Cam (A)	Carbon steel	Heat treated, Specially treated
4	Finger	Carbon steel	Heat treated, Specially treated
5	Cap (A)	Aluminum alloy	Hard anodized
6	End plate (A)	Stainless steel	
7	Tubing	Stainless steel	
8	Guide	Aluminum alloy	Hard anodized
9	Magnet	—	
10	Hexagon socket head bolt	Carbon steel	Zinc chromated
11	Parallel pin	Stainless steel	
12	Type C retaining ring	Carbon steel	Nickel plated

No.	Description	Material	Note
13	Gasket	NBR	
14	Gasket	NBR	
15	Gasket	NBR	
16	Piston seal	NBR	
17	Rod seal	NBR	
18	Rod seal	NBR	
19	Dust cover	CR/FKM/SI	

Replacement Parts

Description		MHSH3-16D	MHSH3-20D	MHSH3-25D	MHSH3-32D MHSHJ3-32D	Main parts
Seal kit		MHSH16-PS	MHSH20-PS	MHSH25-PS	MHSH32-PS	⑬⑭⑮⑯⑰⑱
Dust cover	Material	—	—	—	MHSHJ3-J32	⑲
	CR				MHSHJ3-J32F	
	FKM Silicone rubber				MHSHJ3-J32S	
Finger		P3316054	P3316154	P3316254	P3316354	④
Cam (A)		P3316053	P3316153	P3316253	P3316353	③
Piston assembly		MHS-A1603	MHS-A2003	MHS-A2503	MHS-A3203	②⑨
Cap		MHSH-A1614	MHSH-A2014	MHSH-A2514	MHSH-A3214	⑤

Description		MHSH3-40D MHSHJ3-40D	MHSH3-50D MHSHJ3-50D	MHSH3-63D MHSHJ3-63D	MHSH3-80D MHSHJ3-80D	Main parts
Seal kit		MHSH40-PS	MHSH50-PS	MHSH63-PS	MHSH80-PS	⑬⑭⑮⑯⑰⑱
Dust cover	Material	—	—	—	MHSHJ3-J80	⑲
	CR				MHSHJ3-J80F	
	FKM Silicone rubber				MHSHJ3-J80S	
Finger		P3316454	P3316554	P3316654	P3316754	④
Cam (A)		P3316453	P3316553	P3316653	P3316753	③
Piston assembly		MHS-A4003	MHS-A5003	MHS-A6303	MHS-A8003	②⑨
Cap		MHSH-A4014	MHSH-A5014	MHSH-A6314	MHSH-A8014	⑤

* Order 3 pieces of fingers for one unit.

Replacement part/Grease pack part no.: MH-G01 (30 g)

Construction

Center pusher/Cylinder type

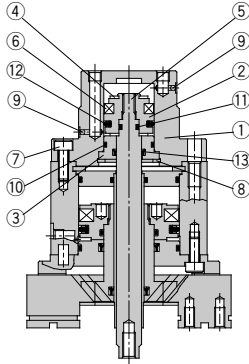

Component Parts

No.	Description	Material	Note
1	Push holder (P)	Aluminum alloy	Hard anodized
2	Piston (P)	Aluminum alloy	Hard anodized
3	Rod holder	Aluminum alloy	Hard anodized
4	Bumper	Urethane rubber	
5	Push rod (P)	Stainless steel	Hard chromed
6	Rubber magnet	Synthetic rubber	
7	Hexagon socket head bolt	Carbon steel	Zinc chromated
8	Type C retaining ring	Carbon steel	Nickel plated
9	Steel balls	Stainless steel	
10	Gasket	NBR	
11	Gasket	NBR	
12	Piston seal	NBR	
13	Rod seal	NBR	

Replacement Parts: Seal Kit (Center pusher/Cylinder type)

Part no.					Description
MHSH3-A32A	MHSH3-A40A	MHSH3-A50A	MHSH3-A63A	MHSH3-A80A	
MHSH32A-PS	MHSH40A-PS	MHSH50A-PS	MHSH63A-PS	MHSH80A-PS	A set of the above nos. ⑩, ⑪, ⑫ & ⑬

* Seal kits are sets consisting of items ⑩, ⑪, ⑫ and ⑬, and can be ordered using the kit number for each cylinder bore size.
Replacement part/Grease pack part no.: MH-G01 (30 g)

Construction

Center pusher/Spring type

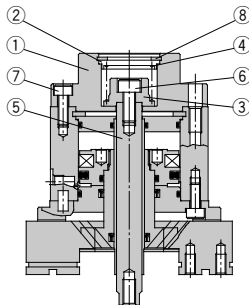

Component Parts

No.	Description	Material	Note
1	Push holder (S)	Aluminum alloy	Hard anodized
2	Cap (S)	Stainless steel	
3	Spring holder	Stainless steel	
4	Spring	Stainless steel	
5	Push rod (S)	Stainless steel	Hard chromed
6	Hexagon socket head bolt	Carbon steel	Zinc chromated
7	Hexagon socket head bolt	Carbon steel	Zinc chromated
8	Type C retaining ring	Carbon steel	Nickel plated

MHZ
MHF
MHL
MHR
MHC
MHS
MHC
MHT
MHY
MHW
-X□
MRHQ
MA
D-□

MHSH3 Series

Gripping Point

- The workpiece gripping point distance should be within the gripping force ranges given for each pressure in the effective gripping force graphs below.
- If operated with the workpiece gripping point beyond the indicated ranges, an excessive offset load will be applied to the sliding section of the fingers, which can have an adverse effect on the service life of the product.

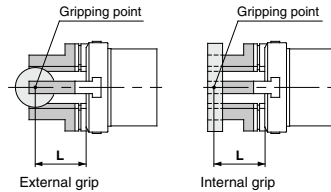

L: Gripping point distance

Effective Gripping Force

- Indication of effective gripping force
The effective gripping force shown in the graphs to the right is expressed as F, which is the thrust of one finger when all 3 of the fingers and attachments are in full contact with the workpiece as shown in the figure below.

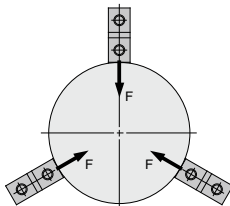

External grip

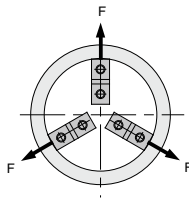

Internal grip

External Gripping Force

MHSH3-16D

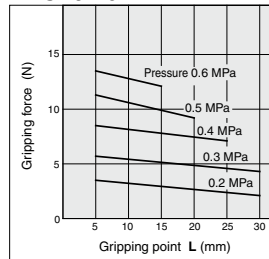

MHSH3-20D

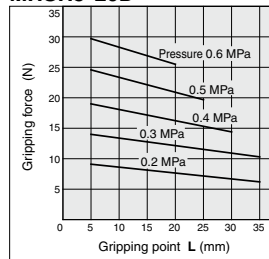

MHSH3-25D

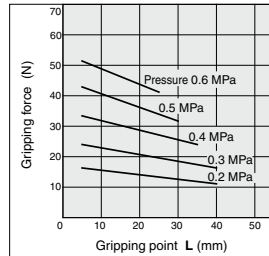

Internal Gripping Force

MHSH3-16D

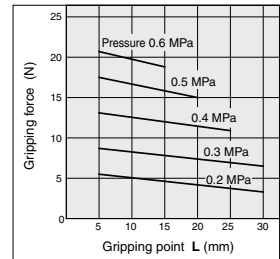

MHSH3-20D

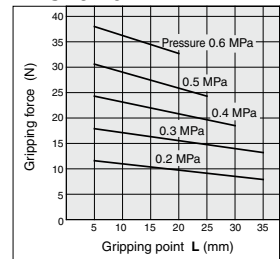

MHSH3-25D

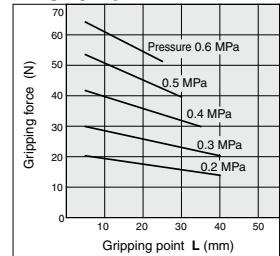

Effective Gripping Force

• Indication of effective gripping force
The effective gripping force shown in the graphs to the right is expressed as F , which is the thrust of one finger when all 3 of the fingers and attachments are in full contact with the workpiece as shown in the figure below.

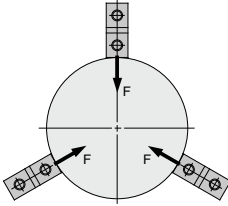

External grip

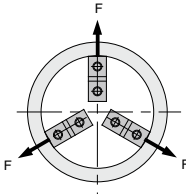

Internal grip

External Gripping Force

MHSH3-32D

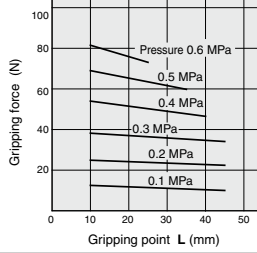

MHSH3-40D

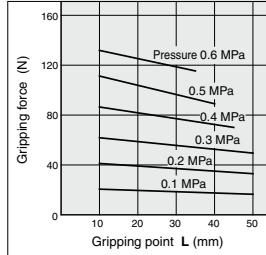

MHSH3-50D

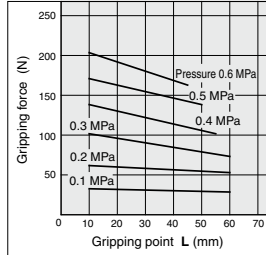

MHSH3-63D

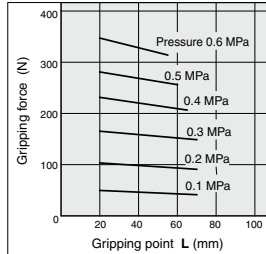

Internal Gripping Force

MHSH3-32D

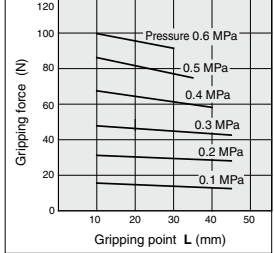

MHSH3-40D

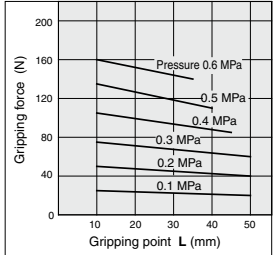

MHSH3-50D

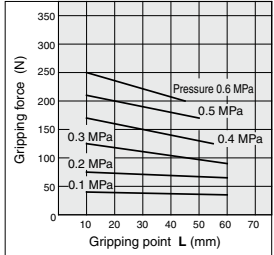

MHSH3-63D

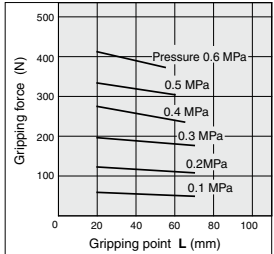

MHZ

MHF

MHL

MHR

MHK

MHS

MHC

MHT

MHY

MHW

-X□

MRHQ

MA

D-□

MHSH3 Series

Effective Gripping Force

- Indication of effective gripping force
The effective gripping force shown in the graphs to the right is expressed as F , which is the thrust of one finger when all 3 of the fingers and attachments are in full contact with the workpiece as shown in the figure below.

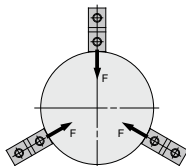

External grip

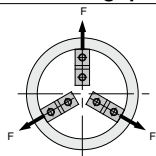

Internal grip

External Gripping Force

MHSH3-80D

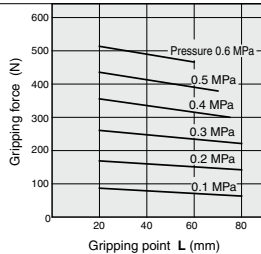

Internal Gripping Force

MHSH3-80D

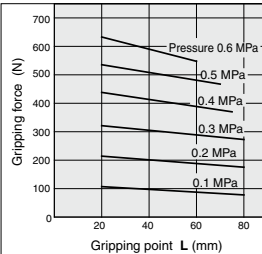

Effective Thrust of Center Pusher

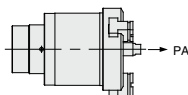

PA: Pusher thrust

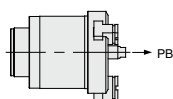

PB: Spring force

Cylinder Type (Note)

MHSH3-32DA

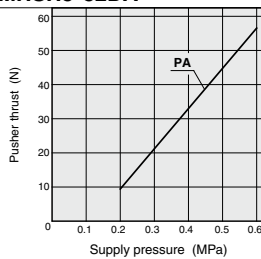

Spring Type

MHSH3-32DB

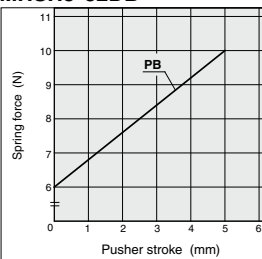

MHSH3-40DA

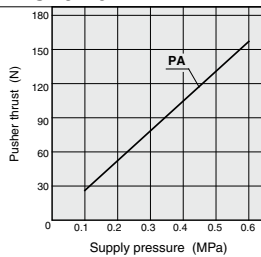

MHSH3-40DB

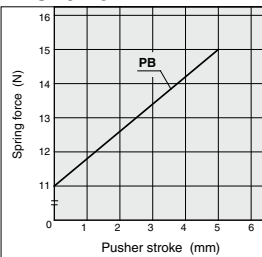

Note) The thrust of the cylinder type is on extension of the push rod.

Effective Thrust of Center Pusher

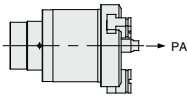

PA: Pusher thrust

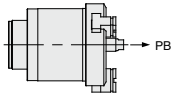

PB: Spring force

Cylinder Type Note)

MHSH3-50DA

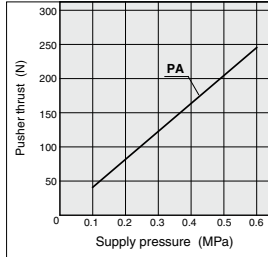

MHSH3-63DA

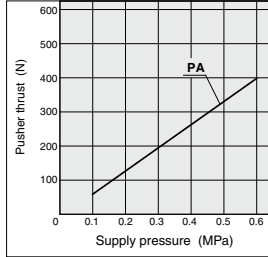

MHSH3-80DA

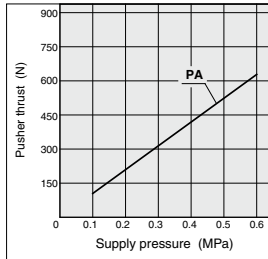

Spring Type

MHSH3-50DB

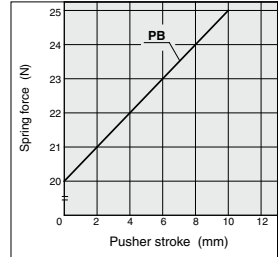

MHSH3-63DB

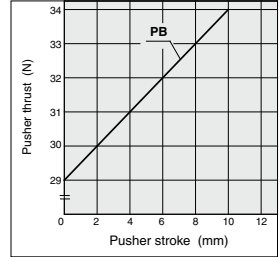

MHSH3-80DB

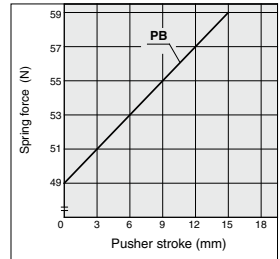

Note) The thrust of the cylinder type is on extension of the push rod.

MHZ

MHF

MHL

MHR

MHK

MHS

MHC

MHT

MHY

MHW

-X□

MRHQ

MA

D-□

MHSH3 Series

Dimensions

MHSH3-16D to 25D

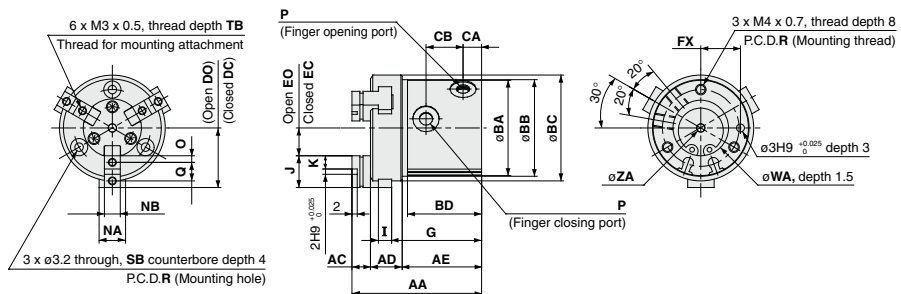

Auto switch mounting groove dimensions (2 locations)

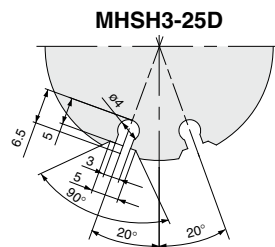
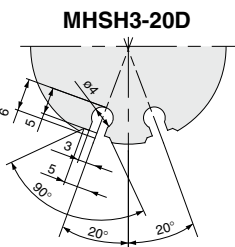
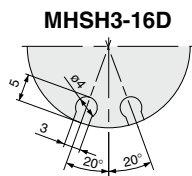

Model	AA	AC	AD	AE	BA	BB	BC	BD	CA	CB	DC	DO	EC	EO	FX	G	I	J	K	NA	NB
MHSH3-16D	46	7	10.5	28.5	30	30.5	34	27	7	14	17.5	19.5	7.5	9.5	12	32	4	10	4	8	5h9 $^{+0.030}_0$
MHSH3-20D	49	7	12	30	36	36.5	40	28	7	14	20	22	8	10	15	34	5	12	5	10	6h9 $^{+0.030}_0$
MHSH3-25D	55	8	13	34	42	42.5	47	32	7.5	17.5	23.5	26.5	9.5	12.5	18	38	5	14	6	12	6h9 $^{+0.030}_0$

Model	O	P	Q	R	SB	TB	WA	ZA
MHSH3-16D	2	M3 x 0.5	6	24	6	5	17H9 $^{+0.043}_0$	3H10 $^{+0.040}_0$
MHSH3-20D	2.5	M5 x 0.8	7	29	6.5	6	21H9 $^{+0.052}_0$	3H10 $^{+0.040}_0$
MHSH3-25D	3	M5 x 0.8	8	34	6.5	6	26H9 $^{+0.052}_0$	4H10 $^{+0.048}_0$

MHSH3-32D to 80D

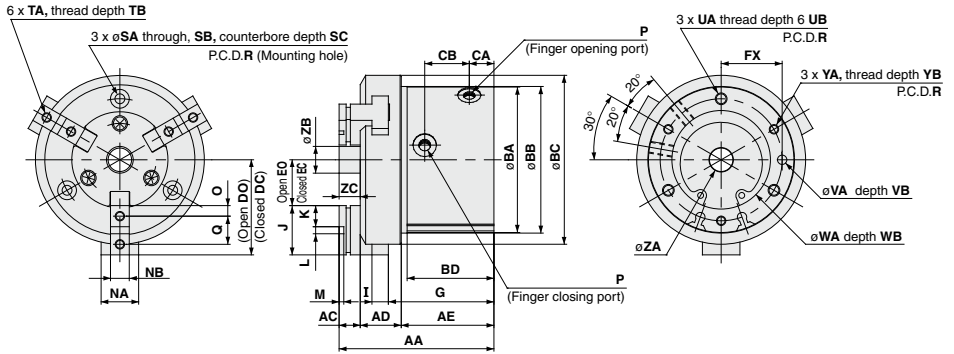

Auto switch mounting groove dimensions (2 locations)

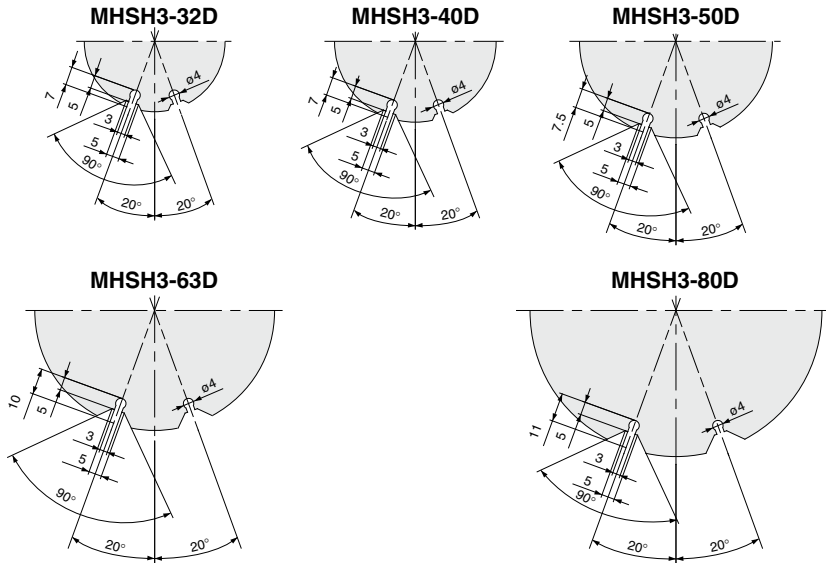

(mm)

Model	AA	AC	AD	AE	BA	BB	BC	BD	CA	CB	DC	DO	EC	EO	FX	G	I	J	K	L	M	NA	NB	O
MHSH3-32D	63	9	15.5	38.5	54	54.5	62	36	9.5	19	31.5	35.5	11.5	15.5	22	43.5	6	20	9	2H9 ^{+0.025} ₀	2	14	8H9 ⁰ _{-0.036}	4.5
MHSH3-40D	66	9	17.5	39.5	62	62.5	72	37	10.5	19	36	40	15	19	26	45	7	21	9	3H9 ^{+0.025} ₀	2	16	8H9 ⁰ _{-0.036}	4.5
MHSH3-50D	80	10	21	49	74	74.5	84	46	11.5	26.5	42	48	18	24	32	55.5	9	24	10	4H9 ^{+0.030} ₀	2	18	10H9 ⁰ _{-0.036}	5
MHSH3-63D	91	12	26	53	92	92.5	102	50	13	28	51	59	23	31	40	61	11	28	11	6H9 ^{+0.030} ₀	3	24	12H9 ⁰ _{-0.043}	5.5
MHSH3-80D	108	15	31.5	61.5	112	112.5	125	57	14	31	63	73	31	41	50	72	12	32	12	8H9 ^{+0.036} ₀	4	28	14H9 ⁰ _{-0.043}	6
Model	P	Q	R	SA	SB	SC	TA	TB	UA	UB	VA	VB	WA	WB	YA	YB	ZA	ZB	ZC					
MHSH3-32D	M5 x 0.8	11	44	4.2	8	7	M4 x 0.7	8	M5 x 0.8	10	4H9 ^{+0.030} ₀	4	34H9 ^{+0.062} ₀	2	M4 x 0.7	8	6H10 ^{+0.048} ₀	7.4	9					
MHSH3-40D	M5 x 0.8	12	52	4.2	8	7	M4 x 0.7	8	M5 x 0.8	10	4H9 ^{+0.030} ₀	4	42H9 ^{+0.062} ₀	2	M4 x 0.7	8	10H10 ^{+0.058} ₀	11.4	9					
MHSH3-50D	M5 x 0.8	14	63	5.1	9.5	8	M5 x 0.8	10	M6 x 1	12	5H9 ^{+0.030} ₀	5	52H9 ^{+0.074} ₀	2	M5 x 0.8	10	12H10 ^{+0.070} ₀	13.4	10					
MHSH3-63D	M5 x 0.8	17	78	6.6	11	8	M5 x 0.8	10	M8 x 1.25	16	6H9 ^{+0.030} ₀	6	65H9 ^{+0.074} ₀	2.5	M6 x 1	12	18H10 ^{+0.070} ₀	17.4	12					
MHSH3-80D	φ1.75 (G 1/8) M4 x 0.8	20	98	6.6	11	8	M6 x 1	12	M8 x 1.25	16	6H9 ^{+0.030} ₀	6	82H9 ^{+0.087} ₀	3	M6 x 1	12	20H10 ^{+0.084} ₀	21.4	15					

MHSH3 Series

Dimensions: Center Pusher/Cylinder Type

MHSH3-32DA to 80DA

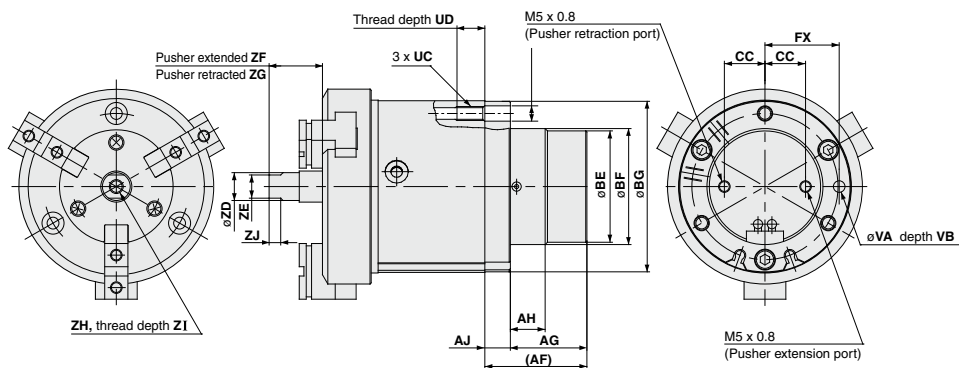

Center pusher auto switch mounting groove dimensions (2 locations)

MHSH3-32DA

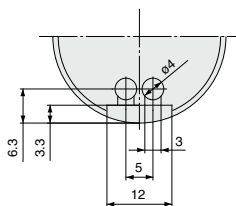

MHSH3-40DA

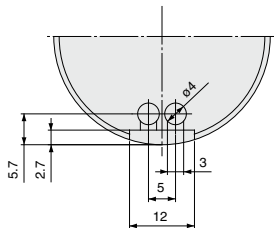

MHSH3-50DA

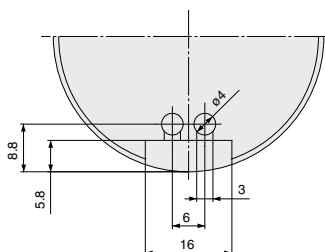

MHSH3-63DA

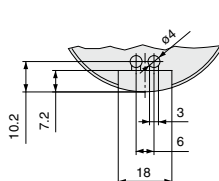

MHSH3-80DA

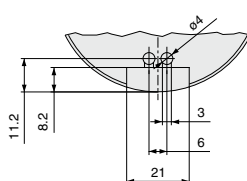

Note) For dimensions, refer to the MHSH3-32 to 80D dimensions on page 611.

Model	AF	AG	AH	AJ	BE	BF	BG	CC	FX	UC	UD	UE	VA	VB	ZD	ZE	ZF	ZG	ZH	ZI	ZJ
MHSH3-32DA	35	26	9	9	30	$32h9_{-0.062}^0$	53.5	9.5	22	M5 x 0.8	10	5.5	$4H9_{-0.030}^0$	4	6	5	20	15	M3 x 0.5	6	3.5
MHSH3-40DA	36	27	12	9	38	$40h9_{-0.062}^0$	61.5	13.5	26	M5 x 0.8	10	5.5	$4H9_{-0.030}^0$	4	10	8	21	16	M5 x 0.8	10	4.5
MHSH3-50DA	44	33	15	11	48	$50h9_{-0.062}^0$	73.5	17.5	32	M6 x 1	12	6.6	$5H9_{-0.030}^0$	5	12	10	28	18	M6 x 1	12	5
MHSH3-63DA	48	35	18	13	58	$60h9_{-0.074}^0$	91.5	20	40	M8 x 1.25	16	8.6	$6H9_{-0.030}^0$	6	16	14	32	22	M8 x 1.25	16	7
MHSH3-80DA	58	45	20	13	68	$70h9_{-0.074}^0$	111.5	25	50	M8 x 1.25	16	8.6	$6H9_{-0.030}^0$	6	20	17	41	26	M10 x 1.5	20	8

Dimensions: Center Pusher/Spring Type

MHSH3-32DB to 80DB

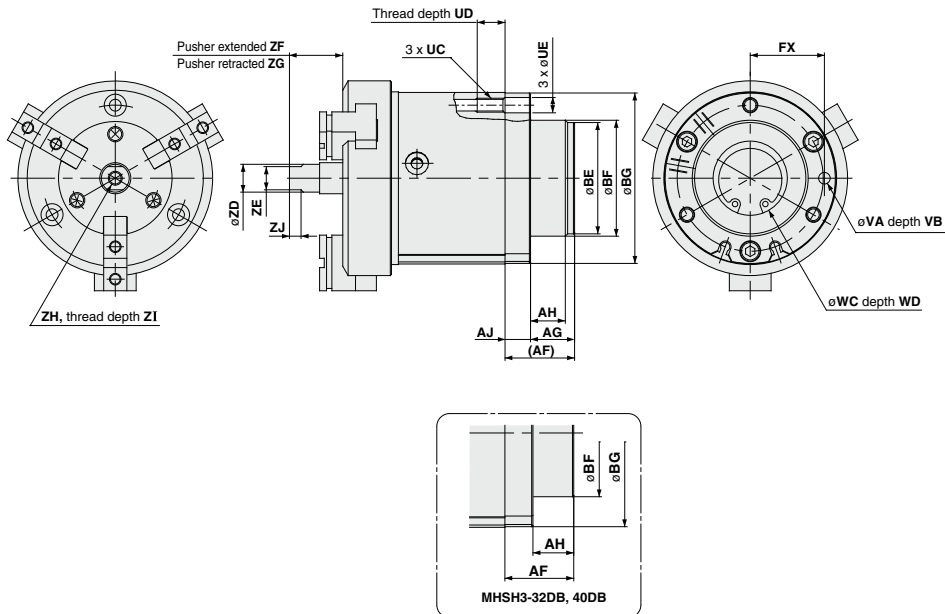

Note) For dimensions, refer to the MHSH3-32 to 80D dimensions on page 611.

Model	AF	AG	AH	AJ	BE	BF	BG	FX	UC	UD	UE	VA	VB	WC	WD	ZD	ZE	ZF	ZG
MHSH3-32DB	18	—	9	9	—	$32h9_{-0.062}$	53.5	22	M5 x 0.8	10	5.5	$4H9_{+0.030/0}$	4	$20_{+0.1/0}$	1.5	6	5	20	15
MHSH3-40DB	21	—	12	9	—	$40h9_{-0.062}$	61.5	26	M5 x 0.8	10	5.5	$4H9_{+0.030/0}$	4	$24_{+0.1/0}$	1.5	10	8	21	16
MHSH3-50DB	30	19	15	11	48	$50h9_{-0.062}$	73.5	32	M6 x 1	12	6.6	$5H9_{+0.030/0}$	5	$32_{+0.1/0}$	1.5	12	10	28	18
MHSH3-63DB	35	22	18	13	58	$60h9_{-0.074}$	91.5	40	M8 x 1.25	16	8.6	$6H9_{+0.030/0}$	6	$42_{+0.1/0}$	2	16	14	32	22
MHSH3-80DB	48	35	20	13	68	$70h9_{-0.074}$	111.5	50	M8 x 1.25	16	8.6	$6H9_{+0.030/0}$	6	$52_{+0.1/0}$	2	20	17	41	26

Model	ZH	ZI	ZJ
MHSH3-32DB	M3 x 0.5	6	3.5
MHSH3-40DB	M5 x 0.8	10	4.5
MHSH3-50DB	M6 x 1	12	5
MHSH3-63DB	M8 x 1.25	16	7
MHSH3-80DB	M10 x 1.5	20	8

- MHZ
- MHF
- MHL
- MHR
- MHK
- MHS**
- MHC
- MHT
- MHY
- MHW
- X□
- MRHQ
- MA
- D-□

MHSH3 Series

Dimensions: Through-hole with Dust Cover

MHSHJ3-32D to 80D

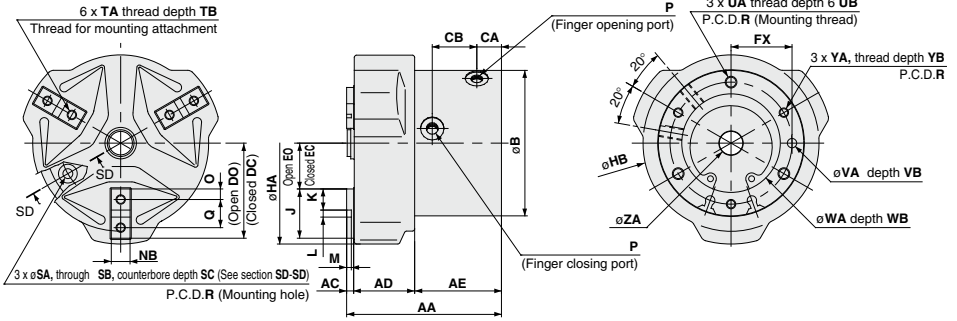

Auto switch mounting groove dimensions (2 locations)

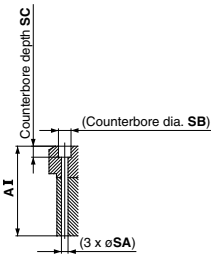

MHSHJ3-32D

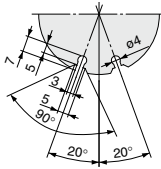

MHSHJ3-40D

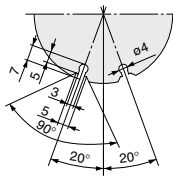

MHSHJ3-50D

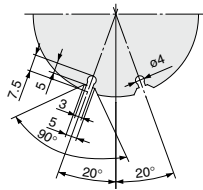

MHSHJ3-63D

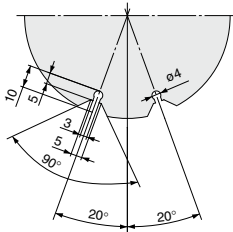

MHSHJ3-80D

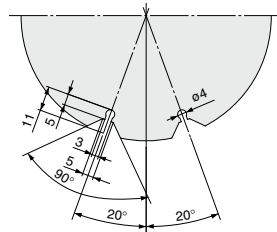

(mm)

Model	AA	AC	AD	AE	AI	B	CA	CB	DC	DO	EC	EO	FX	HA	HB	J	K	L	M	NB
MHSHJ3-32D	63	3	24	36	54	54	9.5	19	31.5	35.5	11.5	15.5	22	80	65	20	9	2H9 ^{+0.025} ₀	2	8H9 ⁰ _{-0.036}
MHSHJ3-40D	66	3	26	37	57	62	10.5	19	36	40	15	19	26	90	75	21	9	3H9 ^{+0.025} ₀	2	8H9 ⁰ _{-0.036}
MHSHJ3-50D	80	3	31	46	70	74	11.5	26.5	42	48	18	24	32	109	88	24	10	4H9 ^{+0.030} ₀	2	10H9 ⁰ _{-0.036}
MHSHJ3-63D	91	4	37	50	79	92	13	28	51	59	23	31	40	133	106	28	11	6H9 ^{+0.030} ₀	3	12H9 ⁰ _{-0.043}
MHSHJ3-80D	108	5	46	57	93	112	14	31	63	73	31	41	50	168	130	32	12	8H9 ^{+0.036} ₀	4	14H9 ⁰ _{-0.043}

Model	O	P	Q	R	SA	SB	SC	TA	TB	UA	UB	VA	VB	WA	WB	YA	YB	ZA
MHSHJ3-32D	4.5	M5 x 0.8	11	44	4.2	8	7	M4 x 0.7	8	M5 x 0.8	10	4H9 ^{+0.030} ₀	4	34H9 ^{+0.062} ₀	2	M4 x 0.7	8	6H10 ^{+0.048} ₀
MHSHJ3-40D	4.5	M5 x 0.8	12	52	4.2	8	7	M4 x 0.7	8	M5 x 0.8	10	4H9 ^{+0.030} ₀	4	42H9 ^{+0.062} ₀	2	M4 x 0.7	8	10H10 ^{+0.058} ₀
MHSHJ3-50D	5	M5 x 0.8	14	63	5.1	9.5	8	M5 x 0.8	10	M6 x 1	12	5H9 ^{+0.030} ₀	5	52H9 ^{+0.074} ₀	2	M5 x 0.8	10	12H10 ^{+0.070} ₀
MHSHJ3-63D	5.5	M5 x 0.8	17	78	6.6	11	8	M5 x 0.8	10	M8 x 1.25	16	6H9 ^{+0.030} ₀	6	65H9 ^{+0.074} ₀	2.5	M6 x 1	12	16H10 ^{+0.070} ₀
MHSHJ3-80D	6	Rc1/8(G1/8, NP1/8)	20	98	6.6	11	8	M6 x 1	12	M8 x 1.25	16	6H9 ^{+0.030} ₀	6	82H9 ^{+0.087} ₀	3	M6 x 1	12	20H10 ^{+0.084} ₀

Dimensions: Center Pusher with Dust Cover/Cylinder Type

MHSHJ3-32DA to 80DA

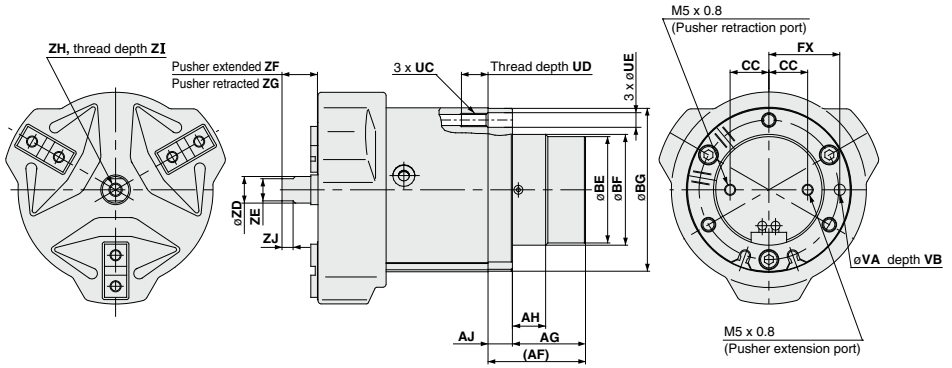

Note) For dimensions, refer to the MHSHJ3-32 to 80D dimensions on page 614.
For auto switch mounting groove, refer to MHSH3-32 to 80DA on page 612.

Model	AF	AG	AH	AJ	BE	BF	BG	CC	FX	UC	UD	UE	VA	VB	ZD	ZE	ZF	ZG	ZH	ZI	ZJ
MHSHJ3-32DA	35	26	9	9	30	32h9 _{-0.062}	53.5	9.5	22	M5 x 0.8	10	5.5	4H9 ^{+0.030} ₀	4	6	5	14	9	M3 x 0.5	6	3.5
MHSHJ3-40DA	36	27	12	9	38	40h9 _{-0.062}	61.5	13.5	26	M5 x 0.8	10	5.5	4H9 ^{+0.030} ₀	4	10	8	15	10	M5 x 0.8	10	4.5
MHSHJ3-50DA	44	33	15	11	48	50h9 _{-0.062}	73.5	17.5	32	M6 x 1	12	6.6	5H9 ^{+0.030} ₀	5	12	10	21	11	M6 x 1	12	5
MHSHJ3-63DA	48	35	18	13	58	60h9 _{-0.074}	91.5	20	40	M8 x 1.25	16	8.6	6H9 ^{+0.030} ₀	6	16	14	24	14	M8 x 1.25	16	7
MHSHJ3-80DA	58	45	20	13	68	70h9 _{-0.074}	111.5	25	50	M8 x 1.25	16	8.6	6H9 ^{+0.030} ₀	6	20	17	31	16	M10 x 1.5	20	8

(mm)

MHZ

MHF

MHL

MHR

MHK

MHS

MHC

MHT

MHY

MHW

-X□

MRHQ

MA

D-□

MHSH3 Series

Dimensions: Center Pusher with Dust Cover/Spring Type

MHSHJ3-32DB to 80DB

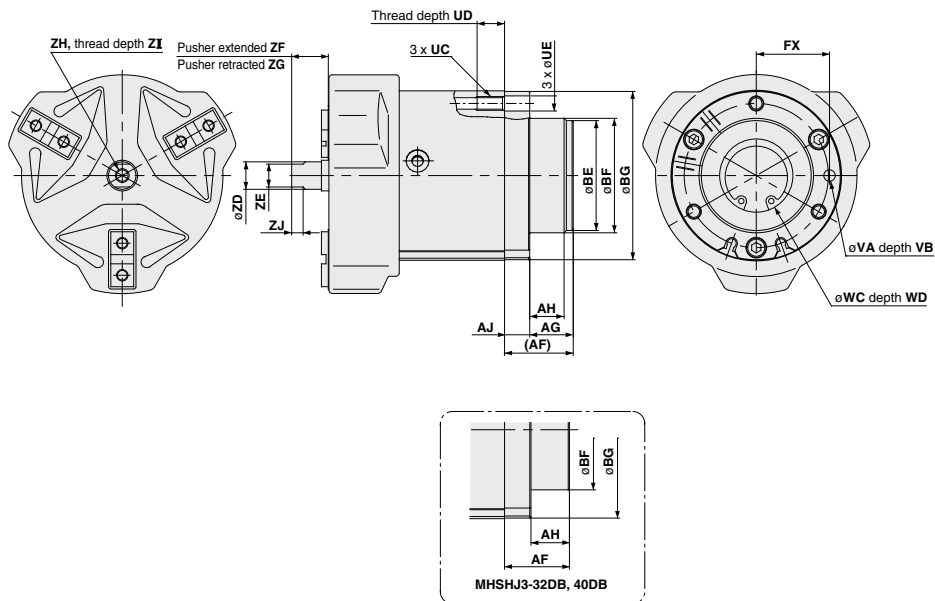

Note) For dimensions, refer to the MHSHJ3-32 to 80D dimensions on page 614.

Model	AF	AG	AH	AJ	BE	BF	BG	FX	UC	UD	UE	VA	VB	WC	WD	ZD	ZE	ZF
MHSHJ3-32DB	18	—	9	9	—	32H9 _{-0.062}	53.5	22	M5 x 0.8	10	5.5	4H9 ^{+0.030} ₀	4	20 ^{+0.1} ₀	1.5	6	5	14
MHSHJ3-40DB	21	—	12	9	—	40H9 _{-0.062}	61.5	26	M5 x 0.8	10	5.5	4H9 ^{+0.030} ₀	4	24 ^{+0.1} ₀	1.5	10	8	15
MHSHJ3-50DB	30	19	15	11	48	50H9 _{-0.062}	73.5	32	M6 x 1	12	6.6	5H9 ^{+0.030} ₀	5	32 ^{+0.1} ₀	1.5	12	10	21
MHSHJ3-63DB	35	22	18	13	58	60H9 _{-0.074}	91.5	40	M8 x 1.25	16	8.6	6H9 ^{+0.030} ₀	6	42 ^{+0.1} ₀	2	16	14	24
MHSHJ3-80DB	48	35	20	13	68	70H9 _{-0.074}	111.5	50	M8 x 1.25	16	8.6	6H9 ^{+0.030} ₀	6	52 ^{+0.1} ₀	2	20	17	31

(mm)

Model	ZG	ZH	ZI	ZJ
MHSHJ3-32DB	9	M3 x 0.5	6	3.5
MHSHJ3-40DB	10	M5 x 0.8	10	4.5
MHSHJ3-50DB	11	M6 x 1	12	5
MHSHJ3-63DB	14	M8 x 1.25	16	7
MHSHJ3-80DB	16	M10 x 1.5	20	8

MHZ
MHF
MHL
MHR
MHK
MHS
MHC
MHT
MHY
MHW
-X□
MRHQ
MA
D-□

Parallel Type Air Gripper/3-Finger Type Long Stroke

MHSL3 Series

ø16, ø20, ø25, ø32, ø40, ø50, ø63, ø80, ø100, ø125

How to Order

Bore size

ø16 to ø25 **MHSL3 - 20 D - M9BW** **Made to Order**

Number of fingers: 3 (3 fingers)

Bore size: 16 (16 mm), 20 (20 mm), 25 (25 mm)

Action: D (Double acting)

Auto switch: Nil (Without auto switch (Built-in magnet))

Number of auto switches: Nil (2 pcs.), S (1 pc.)

* For the applicable auto switch model, refer to the table below.

Applicable Auto Switches/Refer to pages 797 to 850 for further information on auto switches.

Type	Special function	Electrical entry	Indicator light	Wiring (Output)	Load voltage		Auto switch model		Lead wire length (m)*			Pre-wired connector	Applicable load		
					DC	AC	Perpendicular	In-line	0.5 (Nil)	1 (M)	3 (L)			5 (Z)	
Solid state auto switch	—	Grommet	Yes	3-wire (NPN)	24 V	—	M9NV	M9N	●	●	●	○	○	IC circuit	
				3-wire (PNP)			M9PV	M9P	●	●	●	○	○		
				2-wire			M9BV	M9B	●	●	●	○	○		
				3-wire (NPN)			M9NVW	M9NW	●	●	●	○	○		IC circuit
				3-wire (PNP)			M9PVW	M9PW	●	●	●	○	○		
				2-wire			M9BWW	M9BW	●	●	●	○	○		—
	Water resistant (2-color indicator)	Grommet	Yes	3-wire (NPN)	24 V	—	M9NAV**	M9NA**	○	○	●	○	○	IC circuit	
				3-wire (PNP)			M9PAV**	M9PA**	○	○	○	○	○		
				2-wire			M9BAV**	M9BA**	○	○	○	○	○		—

** Water resistant type auto switches can be mounted on the above models, but in such case SMC cannot guarantee water resistance.

* Lead wire length symbols: 0.5 m Nil (Example) M9NVW

1 m M (Example) M9NWM

3 m L (Example) M9NWL

5 m Z (Example) M9NWZ

* Auto switches marked with a "○" symbol are produced upon receipt of order.

Note) When using the 2-color indicator type, please make the setting so that the indicator is lit in red to ensure the detection at the proper position of the air gripper.

Bore size

ø32 to ø125 **MHSL3 - 50 D - M9BW** **Made to Order**

Number of fingers: 3 (3 fingers)

Bore size: 32 (32 mm), 40 (40 mm), 50 (50 mm), 63 (63 mm), 80 (80 mm), 100 (100 mm), 125 (125 mm)

Action: D (Double acting)

Port thread type: Nil (M thread ø32 to ø63), TN (NPT ø80 to ø125), TF (G)

Number of auto switch: Nil (2 pcs.), S (1 pc.), n ("n" pcs.)

Auto switch: Nil (Without auto switch (Built-in magnet))

* For the applicable auto switch model, refer to the table below.

Applicable Auto Switches/Refer to pages 797 to 850 for further information on auto switches.

Type	Special function	Electrical entry	Indicator light	Wiring (Output)	Load voltage		Auto switch model		Lead wire length (m)*			Pre-wired connector	Applicable load		
					DC	AC	Perpendicular	In-line	0.5 (Nil)	1 (M)	3 (L)			5 (Z)	
Solid state auto switch	—	Grommet	Yes	3-wire (NPN)	24 V	—	M9NV	M9N	●	●	●	○	○	IC circuit	
				3-wire (PNP)			M9PV	M9P	●	●	●	○	○		
				2-wire			M9BV	M9B	●	●	●	○	○		
				3-wire (NPN)			M9NVW	M9NW	●	●	●	○	○		IC circuit
				3-wire (PNP)			M9PVW	M9PW	●	●	●	○	○		
				2-wire			M9BWW	M9BW	●	●	●	○	○		—
	Water resistant (2-color indicator)	Grommet	Yes	3-wire (NPN)	24 V	—	M9NAV**	M9NA**	○	○	●	○	○	IC circuit	
				3-wire (PNP)			M9PAV**	M9PA**	○	○	○	○	○		
				2-wire			M9BAV**	M9BA**	○	○	○	○	○		—

** Water resistant type auto switches can be mounted on the above models, but in such case SMC cannot guarantee water resistance.

* Lead wire length symbols: 0.5 m Nil (Example) M9NVW

1 m M (Example) M9NWM

3 m L (Example) M9NWL

5 m Z (Example) M9NWZ

* Auto switches marked with a "○" symbol are produced upon receipt of order.

Note 1) When using the 2-color indicator type, please make the setting so that the indicator is lit in red to ensure the detection at the proper position of the air gripper.

Note 2) When ordering the air gripper with auto switch, auto switch mounting brackets are supplied with the air gripper having a bore size of ø32 to ø125.

Note 3) When ordering the auto switch separately, auto switch mounting brackets (BMG2-012) are required.

Models/Specifications



Model		MHSL3-16D	MHSL3-20D	MHSL3-25D	MHSL3-32D	MHSL3-40D	MHSL3-50D	MHSL3-63D	MHSL3-80D	MHSL3-100D	MHSL3-125D		
Cylinder bore size (mm)		16	20	25	32	40	50	63	80	100	125		
Fluid		Air											
Operating pressure (MPa)		0.2 to 0.6				0.1 to 0.6							
Ambient and fluid temperature (°C)		-10 to 60											
Repeatability (mm)		±0.01											
Max. operating frequency (c.p.m.)		120				60				30			
Lubrication		Not required											
Action		Double acting											
Effective gripping force (N) at 0.5 MPa <small>Note 1)</small>	External grip	14	25	42	74	118	187	335	500	750	1,270		
	Internal grip	16	28	47	82	130	204	359	525	780	1,320		
Opening/Closing stroke (mm) (dia.)		10	10	12	16	20	28	32	40	48	64		
Weight (g)		80	135	180	370	550	930	1,550	2,850	5,500	11,300		

Note 1) Values for ø16 to ø25 are with gripping point L = 20 mm, for ø32 to ø63 with gripping point L = 30 mm, and for ø80 to ø125 with gripping point L = 50 mm. Refer to "Effective Gripping Force" data on pages 621 to 623 for the gripping force at each gripping position.

Symbol

Double acting:
Internal grip

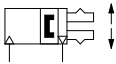

Double acting:
External grip

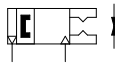

Made to Order

[Click here for details](#)

Symbol	Specifications/Description
-X4	Heat resistance (100°C)
-X5	Fluororubber seal
-X50	Without magnet
-X53	EPDM seal/Fluorine grease
-X56	Axial ported
-X63	Fluorine grease
-X79	Grease for food processing machines, Fluorine grease
-X79A	Grease for food processing machines

Refer to pages 636 to 643 for the specifications of products with auto switches.

- Auto switch installation examples and mounting positions
- Auto switch hysteresis
- Auto switch mounting
- Protrusion of auto switch from edge of body

MHZ

MHF

MHL

MHR

MHK

MHS

MHC

MHT

MHY

MHW

-X□

MRHQ

MA

D-□

MHSL3 Series

Construction

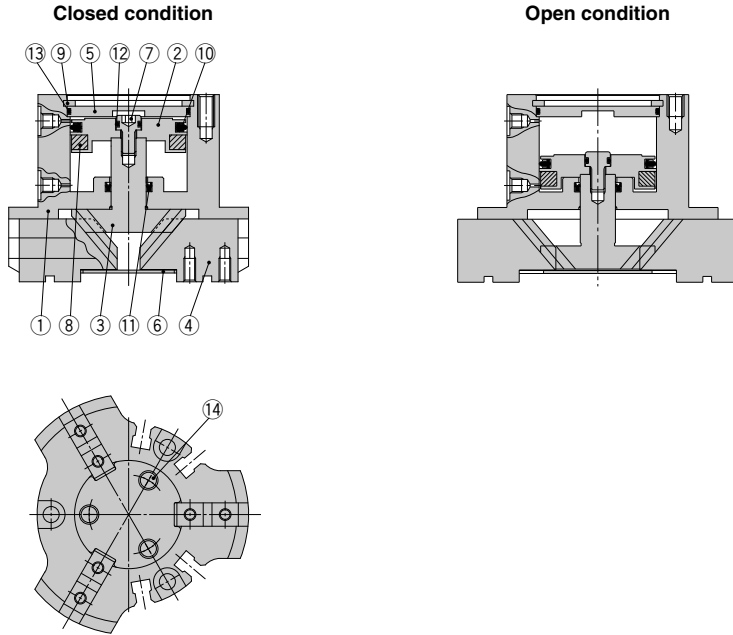

Component Parts

No.	Description	Material	Note
1	Body	Aluminum alloy	Hard anodized
2	Piston	Aluminum alloy	Hard anodized
3	Cam	Carbon steel	Heat treated, Specially treated
4	Finger	Carbon steel	Heat treated, Specially treated
5	Cap	Aluminum alloy	Hard anodized
6	End plate	Stainless steel	
7	Piston bolt	Stainless steel	

No.	Description	Material	Note
8	Magnet	—	
9	Type C retaining ring	Carbon steel	Phosphate coated
10	Piston seal	NBR	
11	Rod seal	NBR	
12	Gasket	NBR	
13	Gasket	NBR	
14	Cross recessed flat head screw	Carbon steel	Zinc chromated

Replacement Parts

Description	MHSL3-16D	MHSL3-20D	MHSL3-25D	MHSL3-32D	MHSL3-40D	Main parts
Seal kit	MHSL16-PS	MHSL20-PS	MHSL25-PS	MHSL32-PS	MHSL40-PS	⑩⑪⑫⑬
Finger	P3316034	P3316134	P3316234	P3316334	P3316434	④
Cam	P3316033	P3316133	P3316233	P3316333	P3316433	③
Piston assembly	MHS-A1601	MHS-A2001	MHS-A2501	MHS-A3201	MHS-A4001	②⑦⑧
End plate assembly	MHSL-A1613	MHSL-A2013	MHSL-A2513	MHSL-A3213	MHSL-A4013	⑥⑭
Cap	MHS-A1614	MHS-A2014	MHS-A2514	MHS-A3214	MHS-A4014	⑤

Description	MHSL3-50D	MHSL3-63D	MHSL3-80D	MHSL3-100D	MHSL3-125D	Main parts
Seal kit	MHSL50-PS	MHSL63-PS	MHSL80-PS	MHSL100-PS	MHSL125-PS	⑩⑪⑫⑬
Finger	P3316534	P3316634	P3316734	P3316834	P3316934	④
Cam	P3316533	P3316633	P3316733	P3316833	P3316933	③
Piston assembly	MHS-A5001	MHS-A6301	MHS-A8001	MHS-A10001	MHS-A12501	②⑦⑧
End plate assembly	MHSL-A5013	MHSL-A6313	MHSL-A8013	MHSL-A10013	MHSL-A12513	⑥⑭
Cap	MHS-A5014	MHS-A6314	MHS-A8014	MHS-A10014	MHS-A12514	⑤

* Order 3 pieces of fingers for one unit.

Replacement part/Grease pack part no.: MH-G01 (30 g)

Gripping Point

- The workpiece gripping point distance should be within the gripping force ranges given for each pressure in the effective gripping force graphs below.
- If operated with the workpiece gripping point beyond the indicated ranges, an excessive offset load will be applied to the sliding section of the fingers, which can have an adverse effect on the service life of the product.

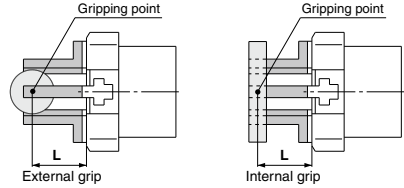

L: Gripping point distance

Effective Gripping Force

- Indication of effective gripping force
The effective gripping force shown in the graphs to the right is expressed as F , which is the thrust of one finger when all 3 of the fingers and attachments are in full contact with the workpiece as shown in the figure below.

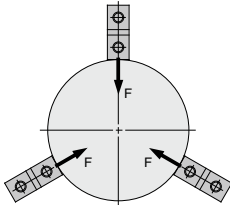

External grip

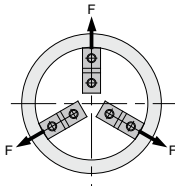

Internal grip

External Gripping Force

MHSL3-16D

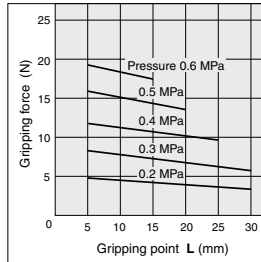

MHSL3-20D

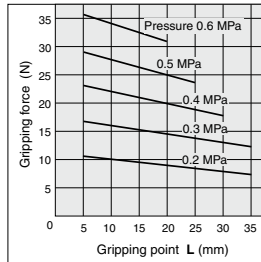

MHSL3-25D

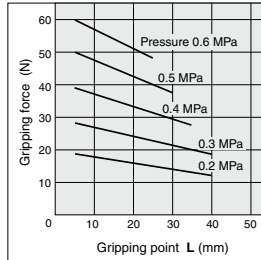

Internal Gripping Force

MHSL3-16D

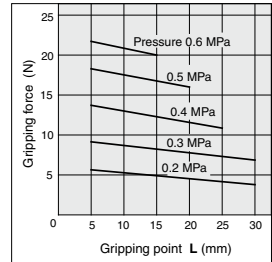

MHSL3-20D

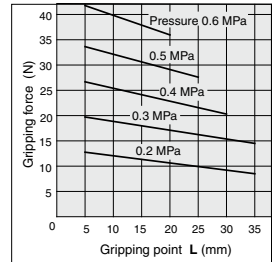

MHSL3-25D

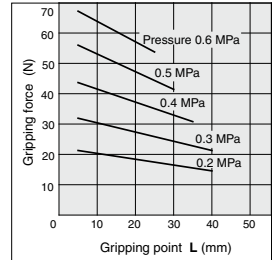

MHZ

MHF

MHL

MHR

MHK

MHS

MHC

MHT

MHY

MHW

-X□

MRHQ

MA

D-□

MHSL3 Series

Effective Gripping Force

• Indication of effective gripping force
 The effective gripping force shown in the graphs to the right is expressed as F , which is the thrust of one finger when all 3 of the fingers and attachments are in full contact with the workpiece as shown in the figure below.

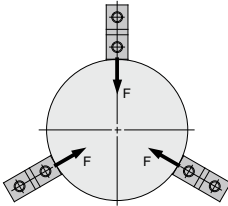

External grip

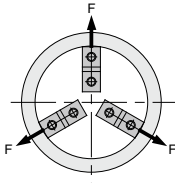

Internal grip

External Gripping Force

MHSL3-32D

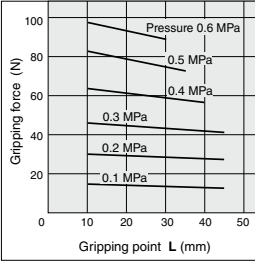

MHSL3-40D

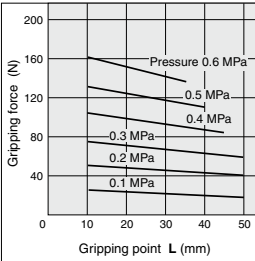

MHSL3-50D

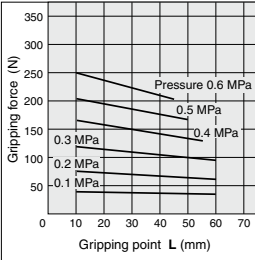

MHSL3-63D

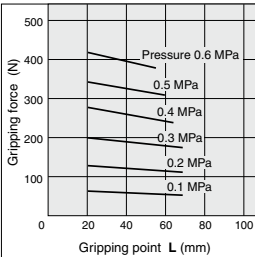

Internal Gripping Force

MHSL3-32D

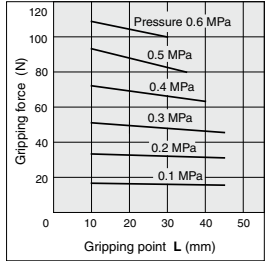

MHSL3-40D

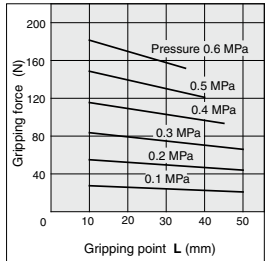

MHSL3-50D

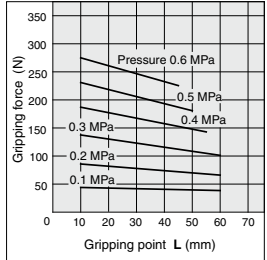

MHSL3-63D

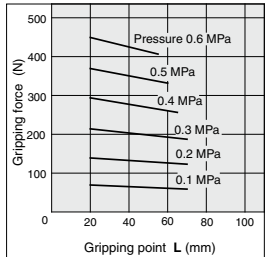

External Gripping Force

MHSL3-80D

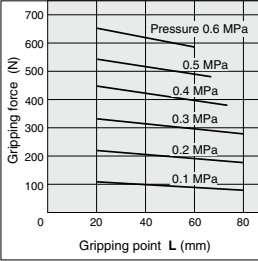

MHSL3-100D

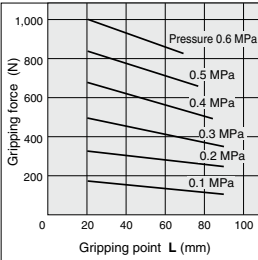

MHSL3-125D

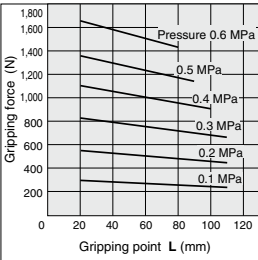

Internal Gripping Force

MHSL3-80D

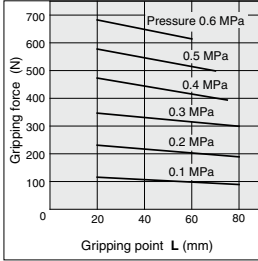

MHSL3-100D

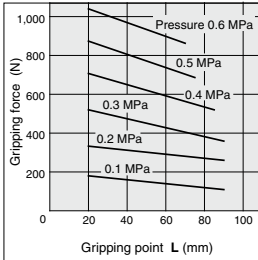

MHSL3-125D

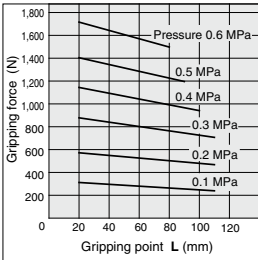

MHZ

MHF

MHL

MHR

MHK

MHS

MHC

MHT

MHY

MHW

-X□

MRHQ

MA

D-□

MHSL3 Series

Dimensions

MHSL3-16D to 25D

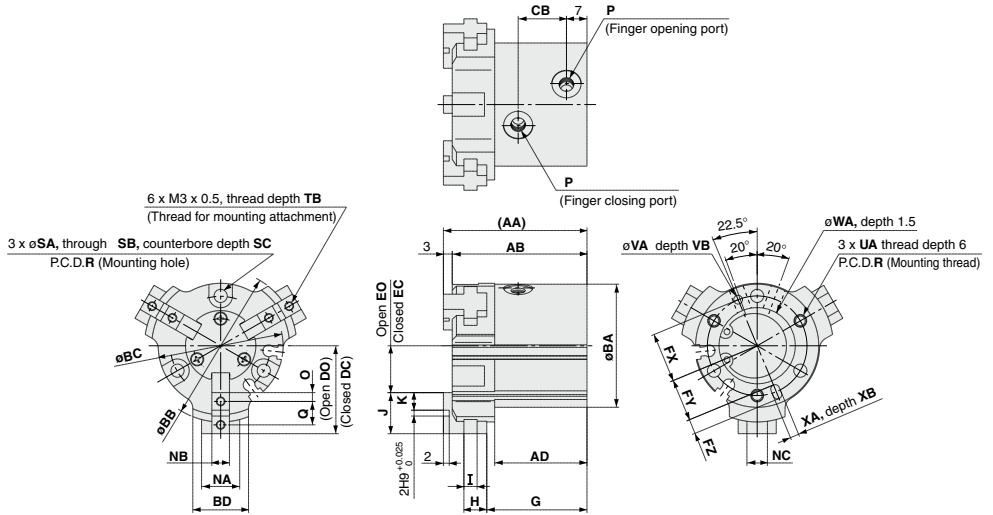

Auto switch mounting groove dimensions (2 locations)

MHSL3-16D

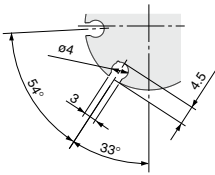

MHSL3-20D/25D

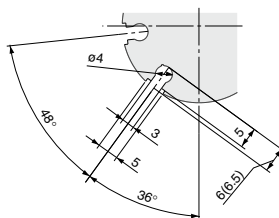

Dimensions inside () are for ø25.

Mounting hole counterbore dimensions

MHSL3-16D

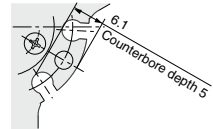

MHSL3-20D

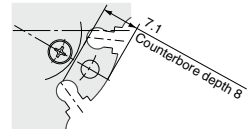

Note) The counterbore configuration differs only for the mounting hole section between the auto switch mounting grooves. (ø16, ø20 only)

Model	AA	AB	AD	BA	BB	BC	BD	CB	DO	DC	EO	EC	FX	FY	FZ	G	H	I	J	K	NA	NB
MHSL3-16D	43.5	40.5	28	30	40	30.6	12	14	23.5	18.5	13.5	8.5	12.5	11	3	30.5	7	4	10	4	8	5h9 ₀ ^{0.030}
MHSL3-20D	46	43	29	36	45	36.6	16	14	26	21	14	9	14.5	13	3	32	8	4	12	5	11	6h9 ₀ ^{0.030}
MHSL3-25D	49	46	31.5	42	52	42.6	19	16.5	30	24	16	10	17	14.5	5	34.2	7.8	4.5	14	6	13	6h9 ₀ ^{0.030}

Model	NC	O	P	Q	R	SA	SB	SC	TB	UA	VA	VB	WA	XA	XB
MHSL3-16D	5	2	M3 x 0.5	6	25	3.4	6.5	5	5	M3 x 0.5	2H9 ₀ ^{+0.025}	2	17H9 ₀ ^{+0.043}	2H9 ₀ ^{+0.025}	2
MHSL3-20D	7	2.5	M5 x 0.8	7	29	3.4	6.5	8	6	M3 x 0.5	2H9 ₀ ^{+0.025}	2	21H9 ₀ ^{+0.052}	2H9 ₀ ^{+0.025}	2
MHSL3-25D	7	3	M5 x 0.8	8	34	4.5	8	8	6	M4 x 0.7	3H9 ₀ ^{+0.025}	3	26H9 ₀ ^{+0.052}	3H9 ₀ ^{+0.025}	3

MHSL3-32D to 80D

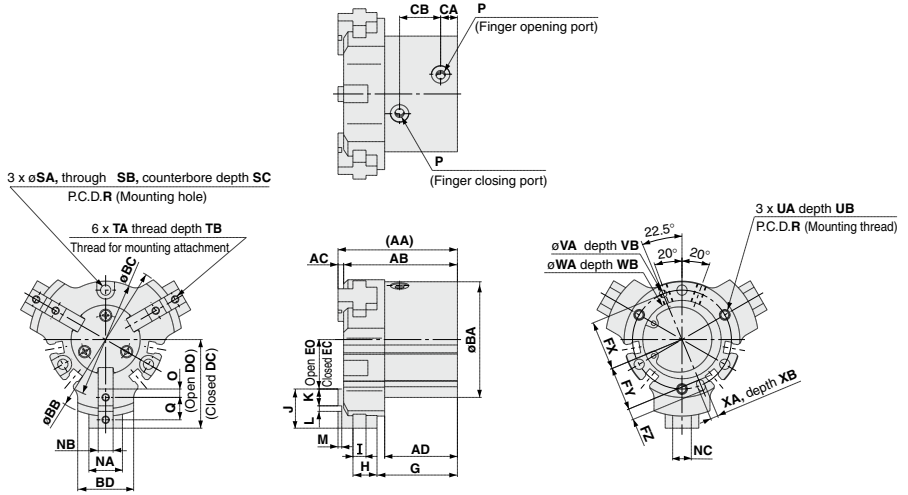

Auto switch mounting groove dimensions (4 locations)

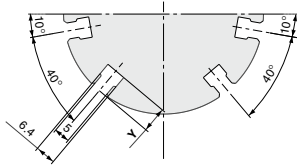

Auto switch mounting groove dimensions

Mounting hole counterbore dimensions

MHSL3-32D

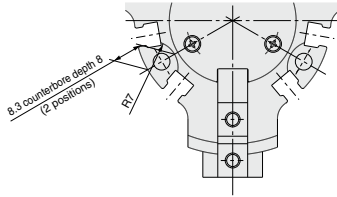

Note) The counterbore configuration differs only for the mounting hole section between the auto switch mounting grooves. (ø32 only)

Model	AA	AB	AC	AD	BA	BB	BC	BD	CA	CB	DO	DC	EO	EC	FX	FY	FZ	G	H	I	J	K
MHSL3-32D	58	55	3	35.5	52	72	52.6	24	8	20	42	34	22	14	22	19.5	5	39.6	10.4	5	20	9
MHSL3-40D	64	61	3	38.5	62	82	62.6	30	9	22	47.5	37.5	26.5	16.5	26.5	23.5	6	42.5	13.5	7	21	9
MHSL3-50D	77.5	74.5	3	46.5	70	104	70.6	32	9	29	60	46	36	22	31	28	6	51.3	17.7	8	24	10
MHSL3-63D	89	85	4	51	86	120	86.6	40	12	30.5	70	54	42	26	38	34.5	7	58.5	19.5	10	28	11
MHSL3-80D	116	111	5	70	106	140	106.6	50	14	37.5	80.5	60.5	48.5	28.5	47.5	43.5	8	78.5	23.5	11	32	12

Model	L	M	NA	NB	NC	O	P	Q	R	SA	SB	SC	TA	TB	UA	UB	VA	VB
MHSL3-32D	2H9 ^{+0.025} ₀	2	16	8H9 ^{+0.036} ₀	10	4.5	M5 x 0.8	11	44	4.5	8	8	M4 x 0.7	8	M4 x 0.7	6	3H9 ^{+0.025} ₀	3
MHSL3-40D	3H9 ^{+0.025} ₀	2	18	8H9 ^{+0.036} ₀	10	4.5	M5 x 0.8	12	53	5.5	9.5	11	M4 x 0.7	8	M5 x 0.8	10	4H9 ^{+0.030} ₀	4
MHSL3-50D	4H9 ^{+0.030} ₀	2	20	10H9 ^{+0.036} ₀	12	5	M5 x 0.8	14	62	5.5	9.5	14.5	M5 x 0.8	10	M5 x 0.8	10	4H9 ^{+0.030} ₀	4
MHSL3-63D	6H9 ^{+0.030} ₀	3	26	12H9 ^{+0.043} ₀	14	5.5	M5 x 0.8	17	76	6.6	11	17	M5 x 0.8	10	M6 x 1	12	5H9 ^{+0.030} ₀	5
MHSL3-80D	8H9 ^{+0.036} ₀	4	30	14H9 ^{+0.043} ₀	16	6	Rc 1/8 (G 1/8, NPT 1/8)	20	95	6.6	11	23	M6 x 1	12	M6 x 1	12	6H9 ^{+0.030} ₀	6

Model	WA	WB	XA	XB	Y
MHSL3-32D	34H9 ^{+0.062} ₀	2	3H9 ^{+0.025} ₀	3	6
MHSL3-40D	42H9 ^{+0.062} ₀	2	4H9 ^{+0.030} ₀	4	8
MHSL3-50D	52H9 ^{+0.074} ₀	2	4H9 ^{+0.030} ₀	4	7
MHSL3-63D	65H9 ^{+0.074} ₀	2.5	5H9 ^{+0.030} ₀	5	7.5
MHSL3-80D	82H9 ^{+0.087} ₀	3	6H9 ^{+0.030} ₀	6	9

- MHZ
- MHF
- MHL
- MHR
- MHK
- MHS**
- MHC
- MHT
- MHY
- MHW
- X□
- MRHQ
- MA
- D-□

MHSL3 Series

Dimensions

MHSL3-100D/125D

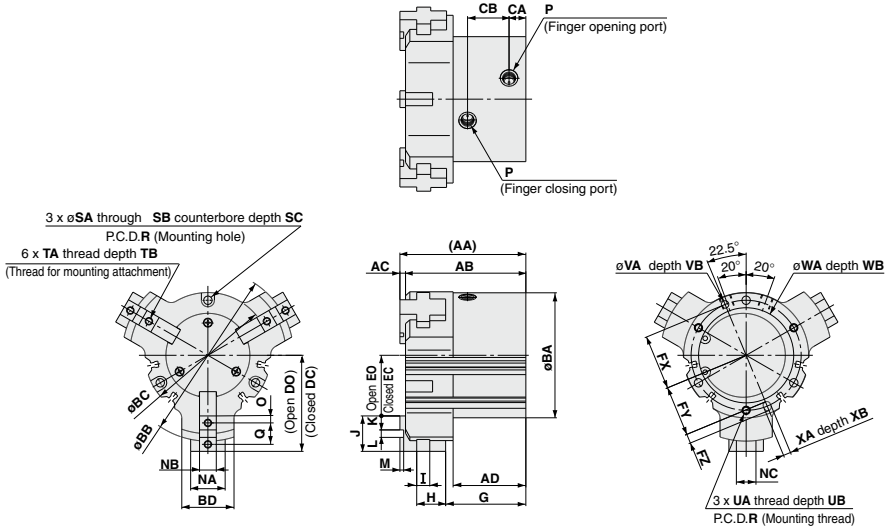

MHSL3-100D

MHSL3-125D

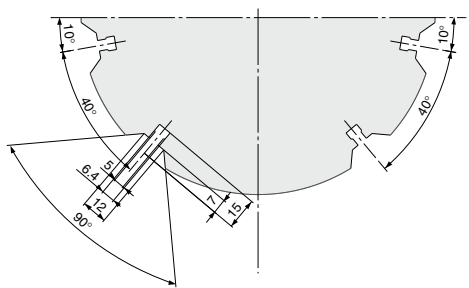
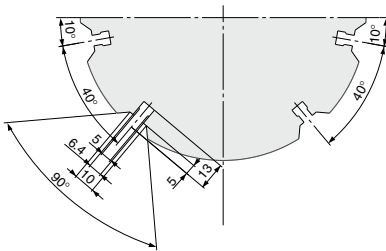

Model	AA	AB	AC	AD	BA	BB	BC	BD	CA	CB	DO	DC	EO	EC	FX	FY	FZ	G	H	I	J	K
MHSL3-100D	135	129	6	78	134	184	134.6	56	18	44.5	103	79	65	41	59	54	10	86	31	14	38	15
MHSL3-125D	175	167	8	102	166	234	166.6	66	24	54	132	100	80	48	74	68	12	112	43	17	52	21

Model	L	M	NA	NB	NC	O	P	Q	R	SA	SB	SC	TA	TB	UA	UB	VA
MHSL3-100D	8H9 ^{+0.036} ₀	4	37	18h9 ⁰ _{-0.043}	21	7.5	R _c 1/4 (G 1/4, NPT 1/4)	23	118	9	14	31	M8 x 1.25	16	M8 x 1.25	16	8H9 ^{+0.036} ₀
MHSL3-125D	10H9 ^{+0.036} ₀	6	43	22h9 ⁰ _{-0.052}	25	10.5	R _c 3/8 (G 3/8, NPT 3/8)	31	148	11	17.5	32	M10 x 1.5	20	M10 x 1.5	20	10H9 ^{+0.036} ₀

Model	VB	WA	WB	XA	XB
MHSL3-100D	6	102H9 ^{+0.067} ₀	4	8H9 ^{+0.036} ₀	6
MHSL3-125D	8	130H9 ^{+0.100} ₀	6	10H9 ^{+0.036} ₀	8

MHSL3 Series Detailed Dimensions of Mounting Portion of End Plate

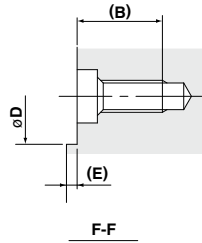
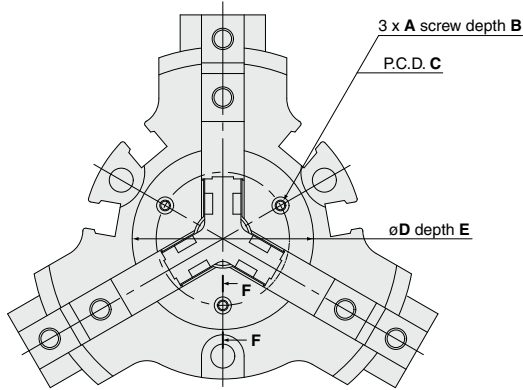

Model	A	B	C	øD	E
MHSL3-16D	M2 x 0.4	5.5	12.5	18 ^{+0.2} _{0.1}	0.5
MHSL3-20D		5.4	16	21.5 ^{+0.2} _{0.1}	0.6
MHSL3-25D		5.2	18.5	24 ^{+0.2} _{0.1}	
MHSL3-32D	M3 x 0.5	5.2	25	34 ^{+0.2} _{0.1}	0.8
MHSL3-40D		8	27	37 ^{+0.2} _{0.1}	1
MHSL3-50D		8	35	44 ^{+0.2} _{0.1}	
MHSL3-63D	8	44	56 ^{+0.2} _{0.1}		
MHSL3-80D	M4 x 0.7	9.5	54	70 ^{+0.2} _{0.1}	1.5
MHSL3-100D			70	90 ^{+0.2} _{0.1}	
MHSL3-125D			80	110 ^{+0.2} _{0.1}	

- MHZ
- MHF
- MHL
- MHR
- MHK
- MHS**
- MHC
- MHT
- MHY
- MHW
- X□
- MRHQ
- MA
- D-□

Parallel Type Air Gripper/4-Finger Type

MHS4 Series

ø16, ø20, ø25, ø32, ø40, ø50, ø63

How to Order

Bore size

ø16 to ø25 **MHS4 - 20D - M9BW** [] - []

Number of fingers ● **4** 4 fingers

Bore size ●

16	16 mm
20	20 mm
25	25 mm

● Action **D** Double acting

● Auto switch **Nil** [Without auto switch (Built-in magnet)]

● Number of auto switches

Nil	2 pcs.
S	1 pc.

● Made to Order
Refer to page 629 for details.

* For the applicable auto switch model, refer to the table below.

Applicable Auto Switches/Refer to pages 797 to 850 for further information on auto switches.

Type	Special function	Electrical entry	Indicator light	Wiring (Output)	Load voltage		Auto switch model		Lead wire length (m)*					Pre-wired connector	Applicable load
					DC	AC	Perpendicular	In-line	0.5 (Nil)	1 (M)	3 (L)	5 (Z)			
Solid state auto switch	—	Grommet	Yes	3-wire (NPN)	24 V	5 V, 12 V	—	M9NV	M9N	●	●	○	○	IC circuit	Relay, PLC
				3-wire (PNP)				M9PV	M9P	●	●	○	○		
				2-wire				M9BV	M9B	●	●	○	○		
				3-wire (NPN)				M9NWV	M9NW	●	●	○	○		
				3-wire (PNP)				M9PWW	M9PW	●	●	○	○		
				2-wire				M9BWW	M9BW	●	●	○	○		
	Diagnosis (2-color indicator)	Grommet	Yes	3-wire (NPN)	24 V	5 V, 12 V	—	M9NAV**	M9NA**	○	○	●	○	IC circuit	Relay, PLC
				3-wire (PNP)				M9PAV**	M9PA**	○	○	●	○		
				2-wire				M9BAV**	M9BA**	○	○	●	○		
				3-wire (NPN)						○	○	○	○		
				3-wire (PNP)						○	○	○	○		
				2-wire						○	○	○	○		
Water resistant (2-color indicator)	Grommet	Yes	3-wire (NPN)	24 V	5 V, 12 V	—	M9NAV**	M9NA**	○	○	●	○	IC circuit	Relay, PLC	
			3-wire (PNP)				M9PAV**	M9PA**	○	○	●	○			
			2-wire				M9BAV**	M9BA**	○	○	●	○			
			3-wire (NPN)						○	○	○	○			
			3-wire (PNP)						○	○	○	○			
			2-wire						○	○	○	○			

** Water resistant type auto switches can be mounted on the above models, but in such case SMC cannot guarantee water resistance.

* Lead wire length symbols: 0.5 m Nil (Example) M9NV
1 m M (Example) M9NVM
3 m L (Example) M9NVL
5 m Z (Example) M9NVZ

* Auto switches marked with a "○" symbol are produced upon receipt of order.

(Note) When using the 2-color indicator type, please make the setting so that the indicator is lit in red to ensure the detection at the proper position of the air gripper.

Bore size

ø32 to ø63 **MHS4 - 50D - M9BW** [] - []

Number of fingers ● **4** 4 fingers

Bore size ●

32	32 mm
40	40 mm
50	50 mm
63	63 mm

● Action **D** Double acting

● Auto switch **Nil** [Without auto switch (Built-in magnet)]

● Number of auto switches

Nil	2 pcs.
S	1 pc.

● Made to Order
Refer to page 629 for details.

* For the applicable auto switch model, refer to the table below.

Applicable Auto Switches/Refer to pages 797 to 850 for further information on auto switches.

Type	Special function	Electrical entry	Indicator light	Wiring (Output)	Load voltage		Auto switch model		Lead wire length (m)*					Pre-wired connector	Applicable load
					DC	AC	Perpendicular	In-line	0.5 (Nil)	1 (M)	3 (L)	5 (Z)			
Solid state auto switch	—	Grommet	Yes	3-wire (NPN)	24 V	5 V, 12 V	—	M9NV	M9N	●	●	○	○	IC circuit	Relay, PLC
				3-wire (PNP)				M9PV	M9P	●	●	○	○		
				2-wire				M9BV	M9B	●	●	○	○		
				3-wire (NPN)				M9NWV	M9NW	●	●	○	○		
				3-wire (PNP)				M9PWW	M9PW	●	●	○	○		
				2-wire				M9BWW	M9BW	●	●	○	○		
	Diagnosis (2-color indicator)	Grommet	Yes	3-wire (NPN)	24 V	5 V, 12 V	—	M9NAV**	M9NA**	○	○	●	○	IC circuit	Relay, PLC
				3-wire (PNP)				M9PAV**	M9PA**	○	○	●	○		
				2-wire				M9BAV**	M9BA**	○	○	●	○		
				3-wire (NPN)						○	○	○	○		
				3-wire (PNP)						○	○	○	○		
				2-wire						○	○	○	○		
Water resistant (2-color indicator)	Grommet	Yes	3-wire (NPN)	24 V	5 V, 12 V	—	M9NAV**	M9NA**	○	○	●	○	IC circuit	Relay, PLC	
			3-wire (PNP)				M9PAV**	M9PA**	○	○	●	○			
			2-wire				M9BAV**	M9BA**	○	○	●	○			
			3-wire (NPN)						○	○	○	○			
			3-wire (PNP)						○	○	○	○			
			2-wire						○	○	○	○			

** Water resistant type auto switches can be mounted on the above models, but in such case SMC cannot guarantee water resistance.

* Lead wire length symbols: 0.5 m Nil (Example) M9NV
1 m M (Example) M9NVM
3 m L (Example) M9NVL
5 m Z (Example) M9NVZ

* Auto switches marked with a "○" symbol are produced upon receipt of order.

Note 1) When using the 2-color indicator type, please make the setting so that the indicator is lit in red to ensure the detection at the proper position of the air gripper.

Note 2) When ordering the air gripper with auto switch, auto switch mounting brackets are supplied with the air gripper having a bore size of ø32 to ø125.

Note 3) When ordering the auto switch separately, auto switch mounting brackets (BMG2-012) are required.

Models/Specifications



Model	MHS4-16D	MHS4-20D	MHS4-25D	MHS4-32D	MHS4-40D	MHS4-50D	MHS4-63D
Cylinder bore size (mm)	16	20	25	32	40	50	63
Fluid	Air						
Operating pressure (MPa)	0.2 to 0.6			0.1 to 0.6			
Ambient and fluid temperature (°C)	-10 to 60						
Repeatability (mm)	±0.01						
Max. operating frequency (c.p.m.)	120			60			
Lubrication	Not required						
Action	Double acting						
Effective gripping force (N) at 0.5 MPa ^(note 1)	External grip	10	19	31	55	88	251
	Internal grip	12	21	35	61	97	268
Opening/Closing stroke (mm)	4	4	6	8	8	12	16
Weight (g)	66	110	154	300	390	590	1,095

Note 1) Values for ø16 to ø25 are with gripping point L = 20 mm, for ø32 to ø63 with gripping point L = 30 mm. Refer to "Effective Gripping Force" data on pages 631 and 632 for the gripping force at each gripping position.

Symbol

Double acting:
Internal grip

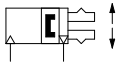

Double acting:
External grip

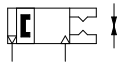

Made to Order

[Click here for details](#)

Symbol	Specifications/Description
-X4	Heat resistance (100°C)
-X5	Fluororubber seal
-X50	Without magnet
-X53	EPDM seal/Fluorine grease
-X56	Axial ported
-X63	Fluorine grease
-X79	Grease for food processing machines, Fluorine grease
-X79A	Grease for food processing machines

Refer to pages 636 to 643 for the specifications of products with auto switches.

- Auto switch installation examples and mounting positions
- Auto switch hysteresis
- Auto switch mounting
- Protrusion of auto switch from edge of body

MHZ

MHF

MHL

MHR

MHK

MHS

MHC

MHT

MHY

MHW

-X□

MRHQ

MA

D-□

MHS4 Series

Construction

Closed condition

Open condition

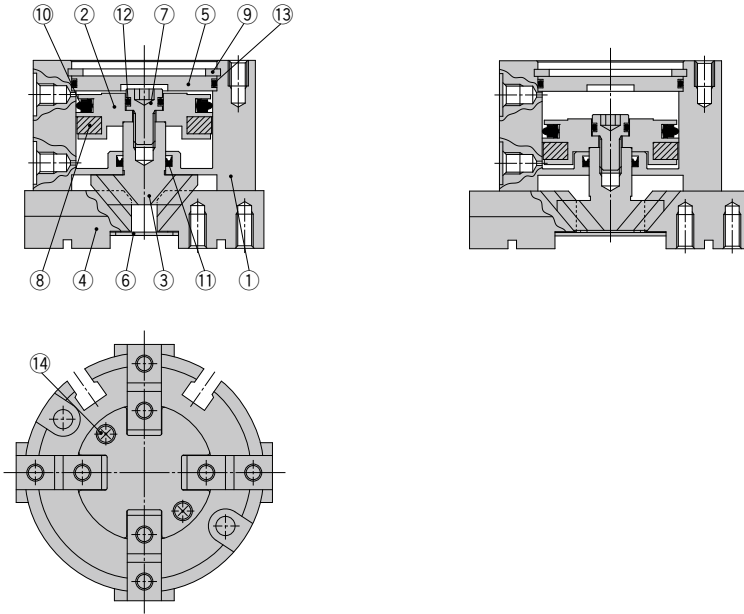

Component Parts

No.	Description	Material	Note
1	Body	Aluminum alloy	Hard anodized
2	Piston	Aluminum alloy	Hard anodized
3	Cam	Carbon steel	Heat treated, Specially treated
4	Finger	Carbon steel	Heat treated, Specially treated
5	Cap	Aluminum alloy	Hard anodized
6	End plate	Stainless steel	
7	Piston bolt	Stainless steel	

No.	Description	Material	Note
8	Magnet	—	
9	Type C retaining ring	Carbon steel	Phosphate coated
10	Piston seal	NBR	
11	Rod seal	NBR	
12	Gasket	NBR	
13	Gasket	NBR	
14	Cross recessed flat head screw	Carbon steel	Zinc chromated

Replacement Parts

Description	MHS4-16D	MHS4-20D	MHS4-25D	MHS4-32D	MHS4-40D	MHS4-50D	MHS4-63D	Main parts
Seal kit	MHS16-PS	MHS20-PS	MHS25-PS	MHS32-PS	MHS40-PS	MHS50-PS	MHS63-PS	⑩⑪⑫⑬
Finger	P3316004	P3316104	P3316204	P3316304	P3316404	P3316504	P3316604	④
Cam	P3316043	P3316143	P3316243	P3316343	P3316443	P3316543	P3316643	③
Piston assembly	MHS-A1601	MHS-A2001	MHS-A2501	MHS-A3201	MHS-A4001	MHS-A5001	MHS-A6301	②⑦⑧
End plate assembly	MHS-A1613-4	MHS-A2013-4	MHS-A2513-4	MHS-A3213-4	MHS-A4013-4	MHS-A5013-4	MHS-A6313-4	⑥⑭
Cap	MHS-A1614	MHS-A2014	MHS-A2514	MHS-A3214	MHS-A4014	MHS-A5014	MHS-A6314	⑤

* Order 4 pieces of fingers for one unit.

Replacement part/Grease pack part no.: MH-G01 (30 g)

Gripping Point

- The workpiece gripping point distance should be within the gripping force ranges given for each pressure in the effective gripping force graphs below.
- If operated with the workpiece gripping point beyond the indicated ranges, an excessive offset load will be applied to the sliding section of the fingers, which can have an adverse effect on the service life of the product.

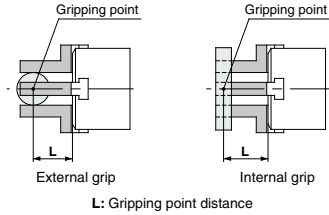

Effective Gripping Force

- Indication of effective gripping force
The gripping force shown in the tables represents the gripping force of one finger when all fingers and attachments are in contact with the workpiece. The gripping force of MHS4 series is the same as MHS2 series while one pair of opposite fingers is used to grip the workpiece and the other pair of fingers is used for positioning.

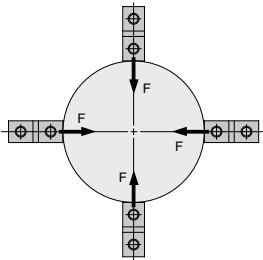

External grip

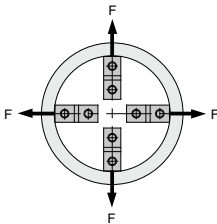

Internal grip

External Gripping Force

MHS4-16D

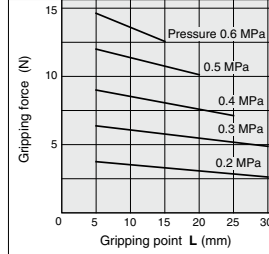

Internal Gripping Force

MHS4-16D

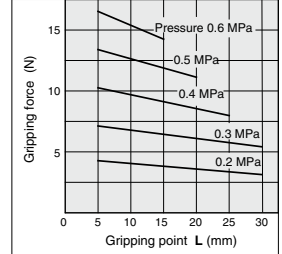

MHS4-20D

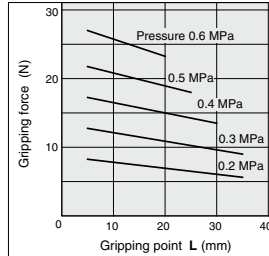

MHS4-20D

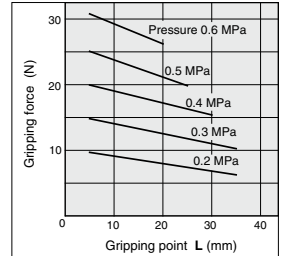

MHS4-25D

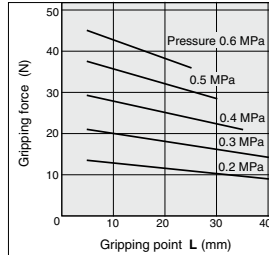

MHS4-25D

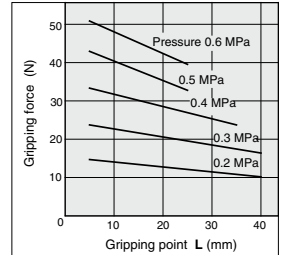

MHZ

MHF

MHL

MHR

MHK

MHS

MHC

MHT

MHY

MHW

-X□

MRHQ

MA

D-□

MHS4 Series

Effective Gripping Force

• Indication of effective gripping force

The gripping force shown in the tables represents the gripping force of one finger when all fingers and attachments are in contact with the workpiece. The gripping force of MHS4 series is the same as MHS2 series while one pair of opposite fingers is used to grip the workpiece and the other pair of fingers is used for positioning.

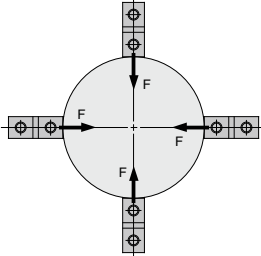

External grip

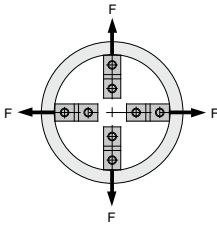

Internal grip

External Gripping Force

MHS4-32 D

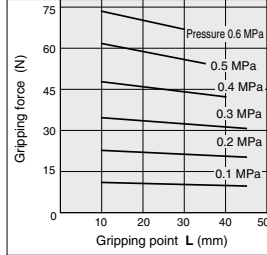

MHS4-40 D

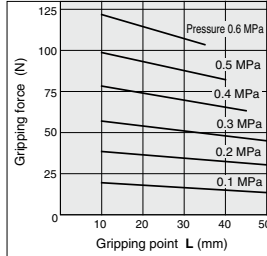

MHS4-50 D

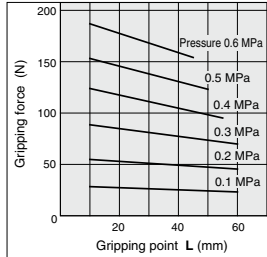

MHS4-63 D

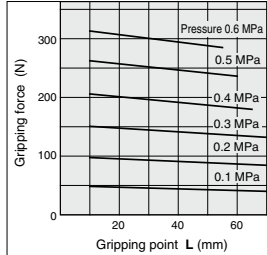

Internal Gripping Force

MHS4-32 D

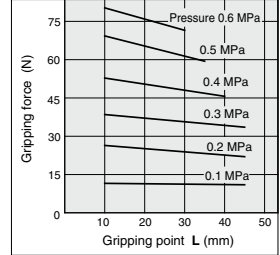

MHS4-40 D

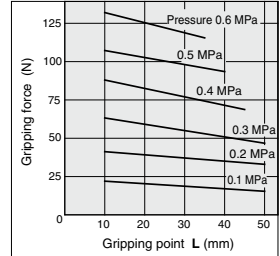

MHS4-50 D

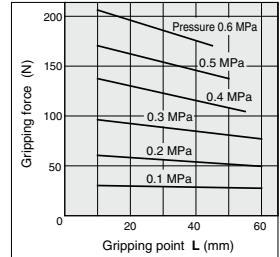

MHS4-63 D

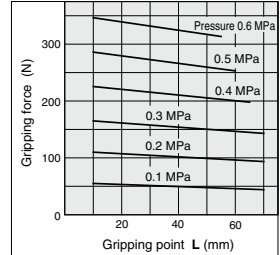

Dimensions

MHS4-16D to 25D

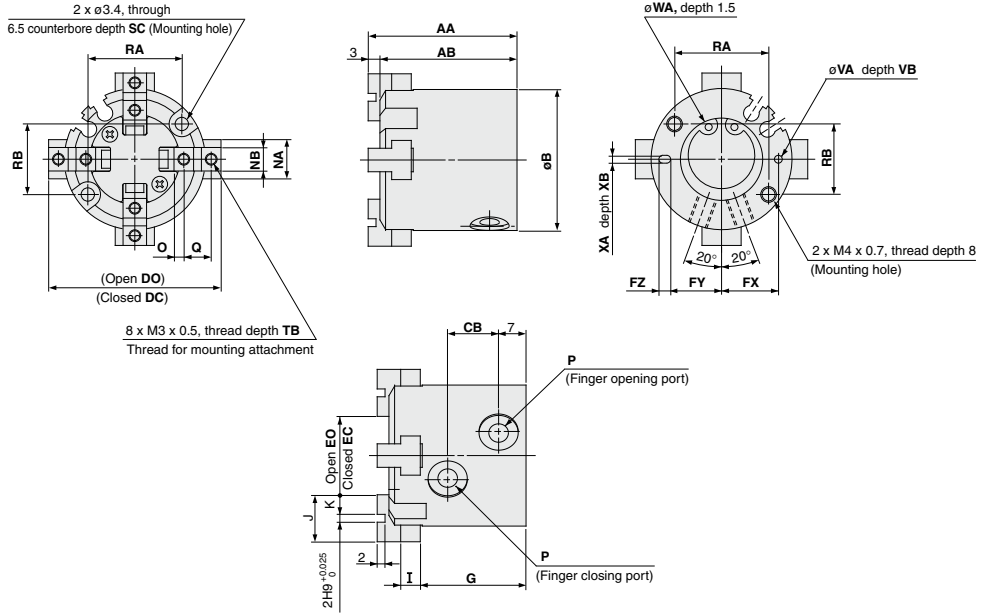

Auto switch mounting groove dimensions (2 locations)

MHS4-16D

MHS4-20D

MHS4-25D

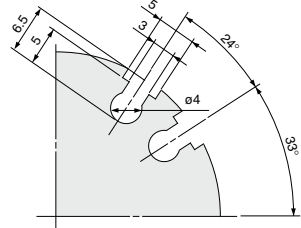
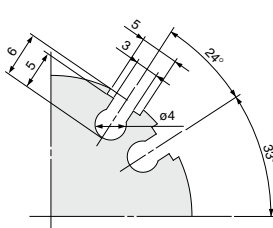
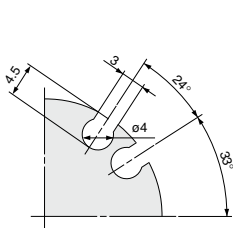

Model	AA	AB	B	CB	DC	DO	EC	EO	FX	FY	FZ	G	I	J	K	NA	NB	O	P	Q
MHS4-16D	35	32	30	11	33	37	13	17	12.5	11	3	25	4	10	4	8	5h9 ₀ ^{+0.030}	2	M3 x 0.5	6
MHS4-20D	38	35	36	13	39	43	15	19	14.5	13	3	27	5	12	5	10	6h9 ₀ ^{+0.030}	2.5	M5 x 0.8	7
MHS4-25D	40	37	42	15	48	54	20	26	17	14.5	5	28	5	14	6	12	6h9 ₀ ^{+0.030}	3	M5 x 0.8	8
Model	RA	RB	SC	TB	VA	VB	WA	XA	XB											
MHS4-16D	18	16	8	5	2H9 ₀ ^{+0.025}	2	17H9 ₀ ^{+0.043}	2H9 ₀ ^{+0.025}	2											
MHS4-20D	24	18	9.5	6	2H9 ₀ ^{+0.025}	2	21H9 ₀ ^{+0.052}	2H9 ₀ ^{+0.025}	2											
MHS4-25D	26	22	10	6	3H9 ₀ ^{+0.025}	3	26H9 ₀ ^{+0.052}	3H9 ₀ ^{+0.025}	3											

- MHZ
- MHF
- MHL
- MHR
- MHK
- MHS**
- MHC
- MHT
- MHY
- MHW
- X□
- MRHQ
- MA
- D-□

MHS4 Series

Dimensions

MHS4-32D/40D

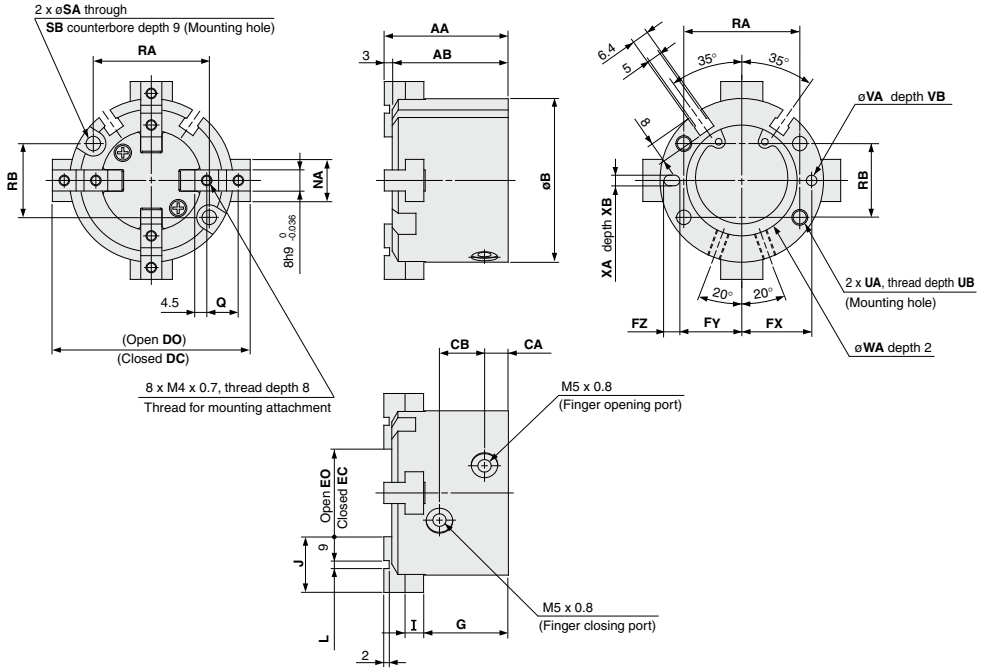

(mm)

Model	AA	AB	B	CA	CB	DC	DO	EC	EO	FX	FY	FZ	G	I	J	L	NA	Q	RA	RB	SA
MHS4-32D	44	41	56	8	16	60	68	20	28	23	20.5	5	30.5	6	20	2H9 $^{+0.025}_0$	14	11	38	25	4.5
MHS4-40D	47	44	62	9	17	66	74	24	32	26.5	23.5	6	32	7	21	3H9 $^{+0.025}_0$	16	12	44	28	5.5

Model	SB	UA	UB	VA	VB	WA	XA	XB
MHS4-32D	8	M5 x 0.8	10	3H9 $^{+0.025}_0$	3	34H9 $^{+0.062}_0$	3H9 $^{+0.025}_0$	3
MHS4-40D	9.5	M6 x 1	12	4H9 $^{+0.030}_0$	4	42H9 $^{+0.062}_0$	4H9 $^{+0.030}_0$	4

MHS4-50D/63D

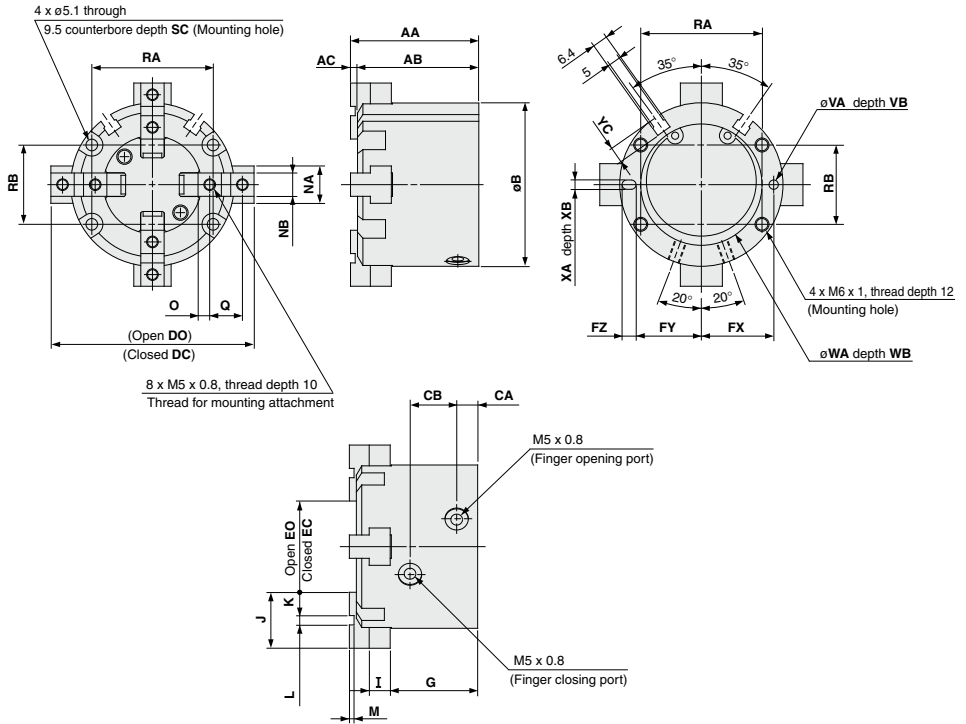

Model	AA	AB	AC	B	CA	CB	DC	DO	EC	EO	FX	FY	FZ	G	I	J	K	L	M	NA	NB
MHS4-50D	55	52	3	70	9	20	74	86	26	38	31	28	6	37.5	9	24	10	4H9 ^{+0.030} ₀	2	18	10h9 ⁰ _{-0.036}
MHS4-63D	66	62	4	86	12	22	91	107	35	51	38	34.5	7	44	11	28	11	6H9 ^{+0.030} ₀	3	24	12h9 ⁰ _{-0.043}

(mm)

Model	O	Q	RA	RB	SC	VA	VB	WA	WB	XA	XB	YC
MHS4-50D	5	14	52	34	12	4H9 ^{+0.030} ₀	4	52H9 ^{+0.074} ₀	2	4H9 ^{+0.030} ₀	4	7
MHS4-63D	5.5	17	66	38	14	5H9 ^{+0.030} ₀	5	65H9 ^{+0.074} ₀	2.5	5H9 ^{+0.030} ₀	5	7.5

MHS4 Series Detailed Dimensions of Mounting Portion of End Plate

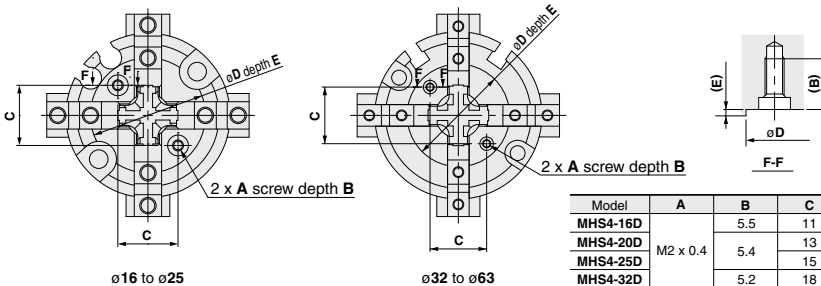

Model	A	B	C	øD	E
MHS4-16D	M2 x 0.4	5.5	11	21 ^{+0.1} ₀	0.5
MHS4-20D		5.4	13	24 ^{+0.1} ₀	0.6
MHS4-25D		5.2	15	27 ^{+0.1} ₀	
MHS4-32D	M3 x 0.5	5.2	18	32 ^{+0.1} ₀	0.8
MHS4-40D		8	21	38 ^{+0.1} ₀	1
MHS4-50D		8	24	42 ^{+0.1} ₀	
MHS4-63D		8	32	54 ^{+0.1} ₀	





- MHZ
- MHF
- MHL
- MHR
- MHK
- MHS**
- MHC
- MHT
- MHY
- MHW
- X□
- MRHQ
- MA
- D-□

MHS Series

Auto Switch Installation Examples and Mounting Positions

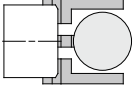
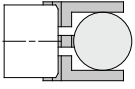
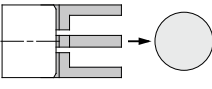
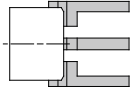
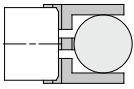
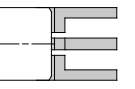
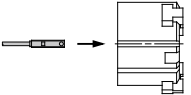
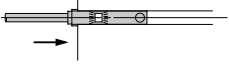
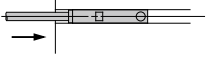
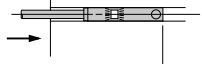
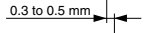
Various auto switch applications are possible through different combinations of auto switch quantities and detecting positions.

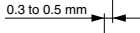
1) Detection when Gripping Exterior of Workpiece



Detection example		1. Confirmation of fingers in reset position	2. Confirmation of workpiece held	3. Confirmation of workpiece released
Position to be detected		Position of fingers fully opened 	Position when gripping a workpiece 	Position of fingers fully closed 
Operation of auto switch		Auto switch turned ON when fingers return. (Light ON)	Auto switch turned ON when gripping a workpiece. (Light ON)	When a workpiece is not held (Abnormal operation): Auto switch to turn ON (Light ON)
Detection combinations	One auto switch = One position, any of ①, ② and ③ can be detected.	●	●	●
	Two auto switches = Two positions of ①, ② and ③ can be detected.	●	●	—
	Pattern	—	●	●
	C	●	—	●
How to determine auto switch installation position		Step 1) Fully open the fingers. 	Step 1) Position fingers for gripping a workpiece. 	Step 1) Fully close the fingers. 
At no pressure or low pressure, connect the auto switch to a power supply, and follow the directions.		Step 2) Insert the auto switch into the auto switch installation groove in the direction shown in the following drawing. 		
		Step 3) Slide the auto switch in the direction of the arrow until the indicator light illuminates. 	Step 3) Slide the auto switch in the direction of the arrow until the indicator light illuminates. Move the switch further 0.3 to 0.5 mm in the direction of the arrow and fasten it.	
		Step 4) Slide the auto switch in the direction of the arrow until the indicator light goes out. 	Position where light turns ON 	
		Step 5) Move the auto switch in the opposite direction until the indicator light illuminates. Move the switch further 0.3 to 0.5 mm beyond the position where the indicator light illuminates and fasten it.	0.3 to 0.5 mm 	
		Position where light turns ON 	Position to be secured 	
		0.3 to 0.5 mm 		
		Position to be secured 		

Note 1) It is recommended that gripping of a workpiece be performed close to the center of the finger stroke.

Note 2) When holding a workpiece close at the end of open/close stroke of fingers, detecting performance of the combinations listed in the above table may be limited, depending on the hysteresis of an auto switch, etc.

Various auto switch applications are possible through different combinations of auto switch quantities and detecting positions.

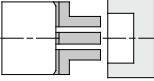
2) Detection when Gripping Interior of Workpiece

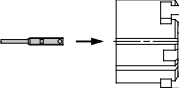
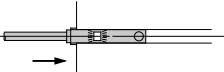
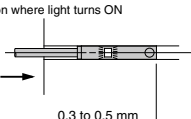
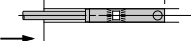
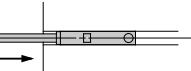
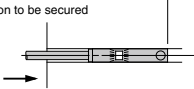
Detection example		1. Confirmation of fingers in reset position	2. Confirmation of workpiece held	3. Confirmation of workpiece released
Position to be detected	Position of fingers fully closed		Position when gripping a workpiece	Position of fingers fully opened
Operation of auto switch	Auto switch turned ON when fingers return. (Light ON)		Auto switch turned ON when gripping a workpiece. (Light ON)	When a workpiece is not held (Abnormal operation): Auto switch to turn ON (Light ON)
Detection combinations	One auto switch = One position, any of ①, ② and ③ can be detected.	●	●	●
	Two auto switches = Two positions of ①, ② and ③ can be detected.	●	●	—
		—	●	●
Pattern	●	—	●	
How to determine auto switch installation position	Step 1) Fully close the fingers.		Step 1) Position fingers for gripping a workpiece.	Step 1) Fully open the fingers.
At no pressure or low pressure, connect the auto switch to a power supply, and follow the directions.	Step 2) Insert the auto switch into the auto switch installation groove in the direction shown in the following drawing.			Also, in case of lead wire entry from the finger direction, installation should be from the direction shown in the drawing.
	Step 3) Slide the auto switch in the direction of the arrow until the indicator light illuminates. Move the switch further 0.3 to 0.5 mm in the direction of the arrow and fasten it.			Step 3) Slide the auto switch in the direction of the arrow until the indicator light illuminates.
	Position where light turns ON			Step 4) Slide the auto switch further in the direction of the arrow until the indicator light goes out.
	Position to be secured			Step 5) Move an auto switch in the opposite direction and fasten it at a position 0.3 to 0.5 mm beyond the position where the indicator light illuminates.
		Position where light turns ON		
	Position to be secured			

Note 1) It is recommended that gripping of a workpiece be performed close to the center of the finger stroke.

Note 2) When holding a workpiece close at the end of open/close stroke of fingers, detecting performance of the combinations listed in the above table may be limited, depending on the hysteresis of an auto switch, etc.

- MHZ
- MHF
- MHL
- MHR
- MHK
- MHS
- MHC
- MHT
- MHY
- MHW
- X□
- MRHQ
- MA
- D-□

Auto Switch Hysteresis

Auto switches have hysteresis similar to micro switches. Use the table below as a guide when adjusting auto switch positions, etc.

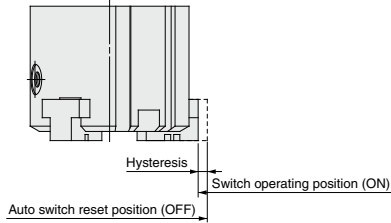

MHS□/MHSL Series

(mm)

Auto switch model Air gripper model	Hysteresis (Max. value)
	D-M9□(V) D-M9□W(V) D-M9□A(V)
MHS□ - 16D MHSL3	0.5
MHS□ - 20D MHSL3	0.5
MHS□ - 25D MHSL3	0.5
MHS□ - 32D MHSL3	0.6
MHS□ - 40D MHSL3	0.6
MHS□ - 50D MHSL3	0.6
MHS□ - 63D MHSL3	0.6
MHS□ - 80D MHSL3	0.6
MHS□ -100D MHSL3	0.6
MHS□ -125D MHSL3	0.6

MHSJ/MHSH Series

(mm)

Auto switch model Air gripper model	Hysteresis (Max. value)
	D-M9□(V) D-M9□W(V) D-M9□A(V)
MHSJ3 -16D MHSH3	0.5
MHSJ3 -20D MHSH3	0.5
MHSJ3 -25D MHSH3	0.5
MHSJ3 -32D MHSH3	0.6
MHSJ3 -40D MHSH3	0.6
MHSJ3 -50D MHSH3	0.6
MHSJ3 -63D MHSH3	0.6
MHSJ3 -80D MHSH3	0.6

(mm)

Auto switch model Air gripper model	Hysteresis (Max. value)
	D-Y59□/Y69□/Y7P(V) D-Y7□W(V)/Y7BA
MHS□ - 32D MHSL3	0.7
MHS□ - 40D MHSL3	0.5
MHS□ - 50D MHSL3	0.5
MHS□ - 63D MHSL3	0.5
MHS□ - 80D MHSL3	0.5
MHS□ -100D MHSL3	0.5
MHS□ -125D MHSL3	0.5

Note) The actual mounting position should be adjusted after confirming the auto switch performance.

Auto Switch Hysteresis

Center pusher/Cylinder type

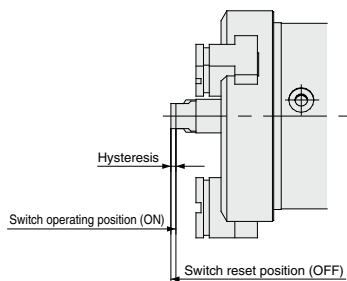

Air gripper model	Auto switch model	Hysteresis (Max. value) (mm)	
		D-M9□(V)	D-M9□W(V) D-M9□A(V)
MHSH□3-32DA		0.3	
MHSH□3-40DA		0.3	
MHSH□3-50DA		0.2	
MHSH□3-63DA		0.4	
MHSH□3-80DA		0.3	

Note) The actual mounting position should be adjusted after confirming the auto switch performance.

MHZ

MHF

MHL

MHR

MHK

MHS

MHC

MHT

MHY

MHW

-X□

MRHQ

MA

D-□

MHS Series

Protrusion of Auto Switch from Edge of Body

The projection of an auto switch from the edge of the body is shown in the table below.

Use the table as a guideline for mounting.

The MHSJ3 and MHS3 series are described on another page.

(mm)

Auto switch model Air gripper model Finger position Lead wire type	Mounting with lead wire on side opposite the fingers				Mounting with lead wire on same side as the fingers				
	In-line entry		Perpendicular entry		In-line entry		Perpendicular entry		
	D-M9□ D-M9□W	D-M9□A	D-M9□V D-M9□WV	D-M9□AV	D-M9□ D-M9□W	D-M9□A	D-M9□V D-M9□WV	D-M9□AV	
MHS□-16D	Open	—	1	—	—	1	3	—	1
	Closed	5	7	3	5	—	—	—	—
MHS□-20D	Open	—	—	—	—	—	—	—	—
	Closed	5	7	3	5	—	—	—	—
MHS□-25D	Open	—	—	—	—	—	1	—	—
	Closed	3	5	1	3	—	—	—	—
MHSL3-16D	Open	—	1	—	—	—	—	—	—
	Closed	5	7	3	5	—	—	—	—
MHSL3-20D	Open	—	—	—	—	—	—	—	—
	Closed	5	7	3	5	—	—	—	—
MHSL3-25D	Open	—	—	—	—	—	—	—	—
	Closed	3	5	1	3	—	—	—	—
MHS□-32D	Open	—	—	—	—	—	—	—	—
	Closed	5.5	7.5	3.5	5.5	—	—	—	—
MHS□-40D	Open	—	—	—	—	—	—	—	—
	Closed	5	7	3.5	5	—	—	—	—
MHS□-50D	Open	—	—	—	—	—	—	—	—
	Closed	4.5	6.5	2.5	4.5	—	—	—	—
MHS□-63D	Open	—	—	—	—	—	—	—	—
	Closed	2.5	4.5	0.5	2.5	—	—	—	—
MHS□-80D	Open	—	—	—	—	—	—	—	—
	Closed	—	—	—	—	—	—	—	—
MHS□-100D	Open	—	—	—	—	—	—	—	—
	Closed	—	—	—	—	—	—	—	—
MHS□-125D	Open	—	—	—	—	—	—	—	—
	Closed	—	—	—	—	—	—	—	—
MHSL3-32D	Open	—	—	—	—	—	—	—	—
	Closed	5.5	7.5	3.5	5.5	—	—	—	—
MHSL3-40D	Open	—	—	—	—	—	—	—	—
	Closed	5	7	3.5	5	—	—	—	—
MHSL3-50D	Open	—	—	—	—	—	—	—	—
	Closed	4.5	6.5	2.5	4.5	—	—	—	—
MHSL3-63D	Open	—	—	—	—	—	—	—	—
	Closed	2.5	4.5	0.5	2.5	—	—	—	—
MHSL3-80D	Open	—	—	—	—	—	—	—	—
	Closed	—	—	—	—	—	—	—	—
MHSL3-100D	Open	—	—	—	—	—	—	—	—
	Closed	—	—	—	—	—	—	—	—
MHSL3-125D	Open	—	—	—	—	—	—	—	—
	Closed	—	—	—	—	—	—	—	—

Note 1) There is no protrusion for sections of the table with no values entered.

Note 2) When mounted with lead wires on the finger side, be sure that attachments and workpieces, etc., do not touch switch units or lead wires.

Note 3) The actual mounting position should be adjusted after confirming the auto switch performance.

Protrusion of Auto Switch from Edge of Body

The projection of an auto switch from the edge of the body is shown in the table below.
Use the table as a guideline for mounting.

Direction of auto switch mounting on air gripper		Mounting with lead wire on side opposite the fingers			Mounting with lead wire on same side as the fingers		
		In-line entry		Perpendicular entry	In-line entry		Perpendicular entry
		D-Y59□ D-Y7P D-Y7□W	D-Y7BA	D-Y69□ D-Y7PV D-Y7□WV	D-Y59□ D-Y7P D-Y7□W	D-Y7BA	D-Y69□ D-Y7PV D-Y7□WV
Open	—	—	—	—	—	—	
	6	9	4	—	5	—	
Closed	—	—	—	—	2.5	—	
	5.5	8	4	—	—	—	
Open	—	—	—	—	—	—	
	5	7.5	3	—	—	—	
Closed	—	—	—	—	—	—	
	3	5	1	—	—	—	
Open	—	—	—	—	—	—	
	—	—	—	—	—	—	
Closed	—	—	—	—	—	—	
	—	—	—	—	—	—	
Open	—	—	—	—	—	—	
	—	—	—	—	—	—	
Closed	—	—	—	—	—	—	
	—	—	—	—	—	—	
Open	—	—	—	—	—	—	
	—	—	—	—	—	—	
Closed	—	—	—	—	—	—	
	—	—	—	—	—	—	
Open	—	—	—	—	—	—	
	—	—	—	—	—	—	
Closed	—	—	—	—	—	—	
	—	—	—	—	—	—	
Open	—	—	—	—	—	—	
	—	—	—	—	—	—	
Closed	—	—	—	—	—	—	
	—	—	—	—	—	—	
Open	—	—	—	—	—	—	
	—	—	—	—	—	—	
Closed	—	—	—	—	—	—	
	—	—	—	—	—	—	

Note 1) There is no protrusion for sections of the table with no values entered.

Note 2) When mounted with lead wires on the finger side, be sure that attachments and workpieces, etc., do not touch switch units or lead wires.

Note 3) The actual mounting position should be adjusted after confirming the auto switch performance.

- MHZ
- MHF
- MHL
- MHR
- MHK
- MHS
- MHC
- MHT
- MHY
- MHW
- X□
- MRHQ
- MA
- D-□

MHS Series

Protrusion of Auto Switch from Edge of Body

The projection of an auto switch from the edge of the body is shown in the table below. Use the table as a guideline for mounting.

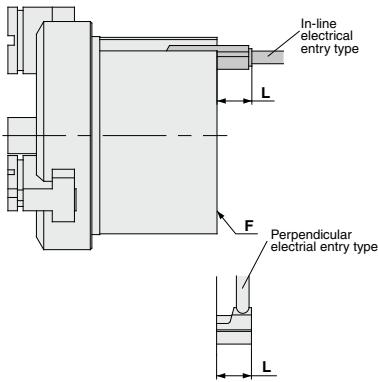

Auto switch model		Lead wire type		In-line entry		Perpendicular entry	
		D-M9□ D-M9□W	D-M9□A	D-M9□V D-M9□WV	D-M9□AV		
Air gripper model	Finger position	MHSJ3-16D	Open	2	4	—	2
		MHSJ3-16D	Closed	5.5	7.5	3.5	5.5
MHSJ3-20D	MHSJ3	Open	2	4	—	2	
		Closed	5	7	3	5	
MHSJ3-25D	MHSJ3	Open	—	3	—	—	
		Closed	5	7	3	5	
MHSJ3-32D	MHSJ3	Open	—	1	—	—	
		Closed	4.5	6.5	2.5	4.5	
MHSJ3-40D	MHSJ3	Open	—	—	—	—	
		Closed	3	5	1	3	
MHSJ3-50D	MHSJ3	Open	—	—	—	—	
		Closed	1.5	3.5	—	1.5	
MHSJ3-63D	MHSJ3	Open	—	—	—	—	
		Closed	—	2	—	—	
MHSJ3-80D	MHSJ3	Open	—	—	—	—	
		Closed	—	1	—	—	

Note 1) Indicates the amount of protrusion from the mounting surface F. There is no protrusion from the finger side.

Note 2) There is no protrusion for sections of the table with no values entered.

Note 3) When mounted with lead wires on the finger side, be sure that attachments and workpieces, etc., do not touch switch units or lead wires.

Note 4) The actual mounting position should be adjusted after confirming the auto switch performance.

Protrusion from Edge of Push Holder (P)

The amount of auto switch protrusion from the push holder (P) end surface is shown in the table below. Use this as a standard when mounting, etc.

Center Pusher/Cylinder Type

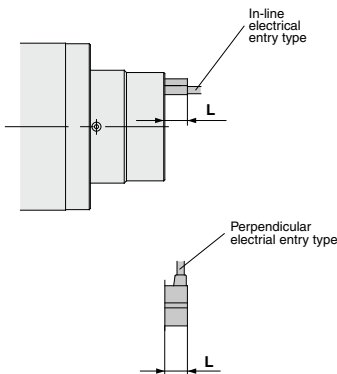

Auto switch model		Lead wire type		In-line entry		Perpendicular entry	
		D-M9□ D-M9□W	D-M9□A	D-M9□V D-M9□WV	D-M9□AV		
Air gripper model	Finger position	MHSH□-32DA	Extended	4	2	2	4
		MHSH□-32DA	Retracted	9	7	7	9
MHSH□-40DA	MHSJ3	Extended	3	—	1	3	
		Retracted	8	6	6	8	
MHSH□-50DA	MHSJ3	Extended	—	—	—	—	
		Retracted	7.5	5.5	5.5	7.5	
MHSH□-63DA	MHSJ3	Extended	—	—	—	—	
		Retracted	7	5	5	7	
MHSH□-80DA	MHSJ3	Extended	—	—	—	—	
		Retracted	4	2	2	4	

Note) The actual mounting position should be adjusted after confirming the auto switch performance.

Auto Switch Mounting

Applicable models:

MHS2-16, 20, 25
 MHS3-16, 20, 25
 MHSJ3-16, 20, 25, 32, 40, 50, 63, 80
 MHSJ3-16, 20, 25, 32, 40, 50, 63, 80
 MHSJ3-A32, 40, 50, 63, 80
 MHSJ3-16, 20, 25
 MHS4-16, 20, 25

To set the auto switch, insert the auto switch into the installation groove of the gripper from the direction indicated in the following drawing. After setting the position, tighten the attached auto switch mounting set screw with a flat head watchmaker's screwdriver.

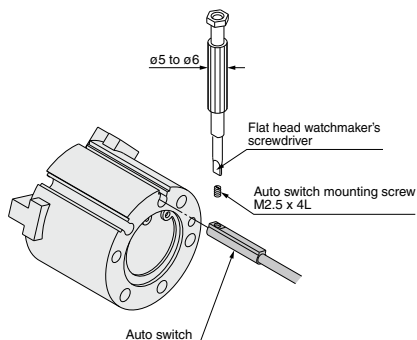

Note) Use a watchmaker's screwdriver with a grip diameter of 5 to 6 mm to tighten the auto switch mounting screw. Also, tighten with a torque of about 0.05 to 0.15 N-m, or about 0.05 to 0.10 N-m for D-M9□A(V).

Applicable models:

MHS2-32, 40, 50, 63
 MHS3-32, 40, 50, 63, 80, 100, 125
 MHSJ3-32, 40, 50, 63, 80, 100, 125
 MHS4-32, 40, 50, 63

- (1) To set the auto switch, insert the auto switch into the installation groove of the cylinder as shown below and set it roughly.
- (2) Insert the auto switch into the auto switch bracket installation groove.
- (3) After confirming the detecting position, tighten the set screws (M2.5) attached to the auto switch and set it.
- (4) Be sure to change the detecting position in the state of (2).

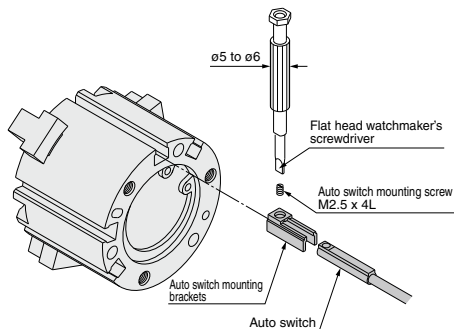

Auto Switch Mounting Bracket Part No.

Auto switch model	Auto switch mounting bracket part no.
D-M9□(V)	BMG2-012
D-M9□W(V)	
D-M9□A(V)	

Note) Use a watchmaker's screwdriver with a grip diameter of 5 to 6 mm to tighten the set screw (M2.5). The tightening torque should be 0.05 to 1 N-m. It should be turned about 90° beyond the point at which tightening can be felt.

MHZ

MHF

MHL

MHR

MHK

MHS

MHC

MHT

MHY

MHW

-X□

MRHQ

MA

D-□

MHS3 Series

Made to Order:

Individual Specifications

1 Single Acting (Normally open, Normally closed)

Symbol
-X84

Piping from two directions are possible

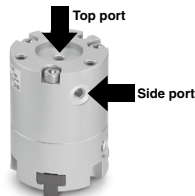

Piping and auto switch wiring entries are one way. (For top ported)

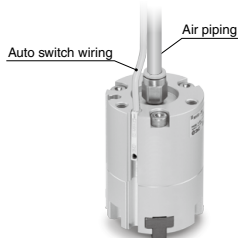

How to Order

MHS3 - 20 S - M9BW - X84

- Number of fingers**: 3 (3 fingers)
- Bore size**:

16	16 mm
20	20 mm
25	25 mm
32	32 mm
40	40 mm
50	50 mm
63	63 mm
- Action**:

S	Single acting (Normally open)
C	Single acting (Normally closed)
- Auto switch**:

Nil	2 pcs.	ø16 to ø63
S	1 pc.	
n	"n" pcs.	ø32 to ø63
- Number of auto switches**:

Nil	Without auto switch (Built-in magnet)
-----	---------------------------------------
- Single acting**

* For the applicable auto switch model, refer to the table below.

Applicable Auto Switches/Refer to pages 797 to 850 for further information on auto switches.

Type	Special function	Electrical entry	Indicator light	Wiring (Output)	Load voltage		Auto switch model		Lead wire length (m)*					Pre-wired connector	Applicable load
					DC	AC	Perpendicular	In-line	0.5 (Nil)	1 (M)	3(L)	5(Z)			
Solid state auto switch	—	Grommet	Yes	3-wire (NPN)	24 V	—	M9NV	M9N	●	●	○	○	○	IC circuit	Relay, PLC
				3-wire (PNP)			M9PV	M9P	●	●	○	○			
	2-wire			M9BV	M9B	●	●	○	○	○	IC circuit				
	3-wire (NPN)			M9NVV	M9NV	●	●	○	○	○					
	3-wire (PNP)			M9PVV	M9PV	●	●	○	○	○	—				
	2-wire			M9BVV	M9BV	●	●	○	○	○					
	3-wire (NPN)			M9NAV**	M9NA**	○	○	●	○	○	IC circuit				
	3-wire (PNP)			M9PAV**	M9PA**	○	○	○	○	○					
	2-wire			M9BAV**	M9BA**	○	○	○	○	○	—				

** Water resistant type auto switches can be mounted on the above models, but in such case SMC cannot guarantee water resistance.

* Lead wire length symbols: 0.5 m Nil (Example) M9N
1 m M (Example) M9NWM
3 m L (Example) M9NL
5 m Z (Example) M9NZ

* Solid state auto switches marked with "○" are produced upon receipt of order.

Note 1) When using the 2-color indicator, please make the setting so that the indicator is lit in red to ensure the detection at the proper position of the air gripper.

Note 2) When ordering the air gripper with auto switch in MHS3-32S to 63S series, auto switch mounting brackets are required (shipped together). In addition, when ordering the auto switch separately, auto switch mounting brackets (BMG2-012) are required.

Models/Specifications

Model		MHS3-16□-X84	MHS3-20□-X84	MHS3-25□-X84	MHS3-32□-X84	MHS3-40□-X84	MHS3-50□-X84	MHS3-63□-X84	
Cylinder bore size (mm)		16	20	25	32	40	50	63	
Fluid		Air							
Operating pressure (MPa)		0.35 to 0.6			0.25 to 0.6				
Ambient and fluid temperature (°C)		-10 to 60							
Repeatability (mm)		±0.01							
Max. operating frequency (c.p.m.)		120			60				
Lubrication		Not required							
Action		Single acting: Normally open, Normally closed							
Opening/Closing stroke (mm)(dia.)		4	4	6	8	8	12	16	
Normally open	External grip ^{Note) (N)} at 0.5 MPa	Near fully closed	9.6	17.5	29.4	56	92	144	238
		Near fully opened	10.4	19	31.7	60	99	153	258
	Internal grip ^{Note) (N)} Spring force only	Near fully closed	4.1	7.4	12.5	17.5	25.8	42.2	68.4
		Near fully opened	3.3	6	10.3	13.5	19	33.6	49
Weight (g)		85	145	210	350	485	740	1330	
Normally closed	Internal grip ^{Note) (N)} at 0.5 MPa	Near fully closed	12.3	21.2	36.5	68	108	169	279
		Near fully opened	11.3	19.9	34.2	64	103	160	259
	External grip ^{Note) (N)} Spring force only	Near fully closed	3.6	6.2	10.3	13.5	21.2	33.6	49
		Near fully opened	4.6	7.4	12.5	17.5	26.6	42.2	68.4
Weight (g)		85	145	210	345	485	740	1280	

Note) Values for ø16 to ø25 based on gripping point L = 20 mm, for ø32 to ø63 based on gripping point L = 30 mm.
Refer to "Effective Gripping Force" data on pages 646 and 647 for the gripping force at each gripping position.

Symbol

Single acting/Normally open: External grip



Single acting/Normally closed: Internal grip

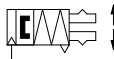

Replacement Parts: Seal kit (Piston seal, Rod seal, Gaskets)

Description	MHS3-16□-X84	MHS3-20□-X84	MHS3-25□-X84	MHS3-32□-X84	MHS3-40□-X84	MHS3-50□-X84	MHS3-63□-X84
Normally open	MHS16-PS-X84-S	MHS20-PS-X84-S	MHS25-PS-X84-S	MHS32-PS-X84-S	MHS40-PS-X84-S	MHS50-PS-X84-S	MHS63-PS-X84-S
Normally closed	MHS16-PS-X84-C	MHS20-PS-X84-C	MHS25-PS-X84-C	MHS32-PS-X84-C	MHS40-PS-X84-C	MHS50-PS-X84-C	MHS63-PS-X84-C

Replacement parts/Grease pack part no.: MH-G01 (30 g)

MHZ

MHF

MHL

MHR

MHK

MHS

MHC

MHT

MHY

MHW

-X□

MRHQ

MA

D-□

MHS3 Series

Gripping Point

- The workpiece gripping point distance should be within the gripping force ranges given for each pressure in the effective gripping force graphs below.
- If operated with the workpiece gripping point beyond the indicated ranges, an excessive offset load will be applied to the sliding section of the fingers, which can have an adverse effect on the service life of the product.

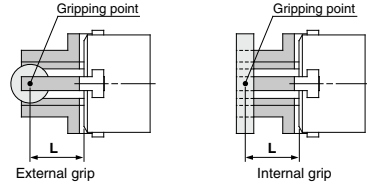

L: Gripping point distance

External Effective Gripping Force

- Indication of effective gripping force
The effective gripping force shown in the graphs to the right is expressed as F , which is the thrust of one finger when all 3 of the fingers and attachments are in full contact with the workpiece as shown in the figure below.

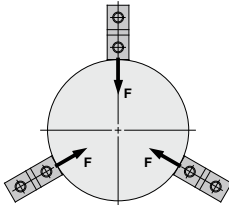

External grip

MHS3-16S-X84

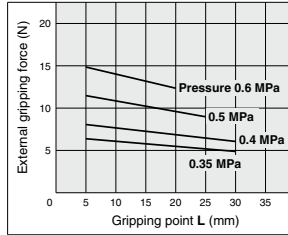

MHS3-40S-X84

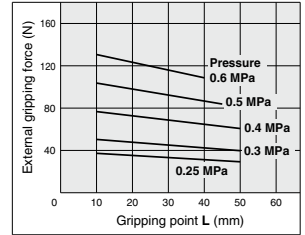

MHS3-20S-X84

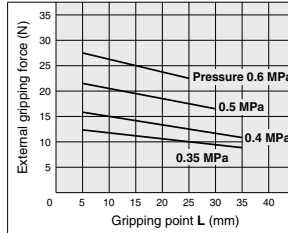

MHS3-50S-X84

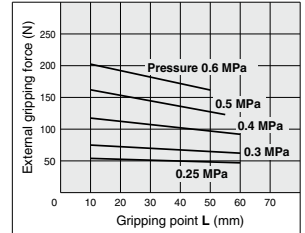

MHS3-25S-X84

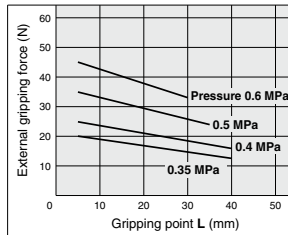

MHS3-63S-X84

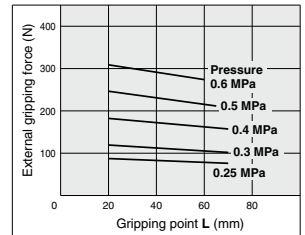

MHS3-32S-X84

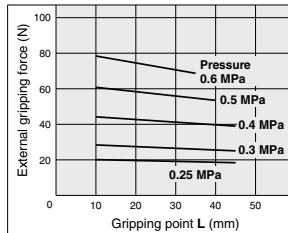

Internal Effective Gripping Force

- Indication of effective gripping force
The effective gripping force shown in the graphs to the right is expressed as F , which is the thrust of one finger when all 3 of the fingers and attachments are in full contact with the workpiece as shown in the figure below.

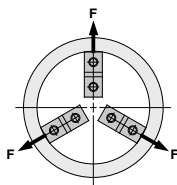

Internal grip

MHS3-16C-X84

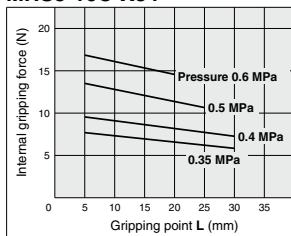

MHS3-40C-X84

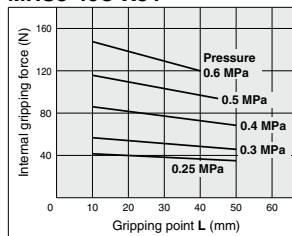

MHS3-20C-X84

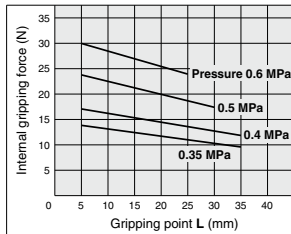

MHS3-50C-X84

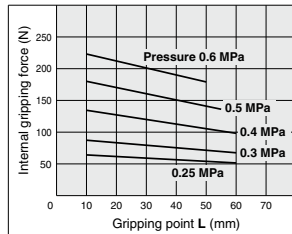

MHS3-25C-X84

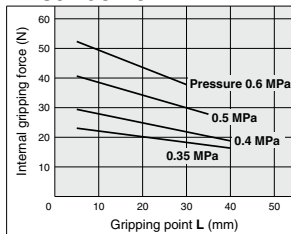

MHS3-63C-X84

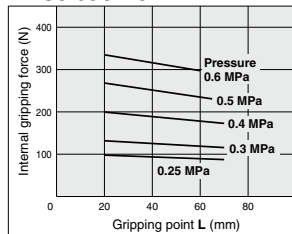

MHS3-32C-X84

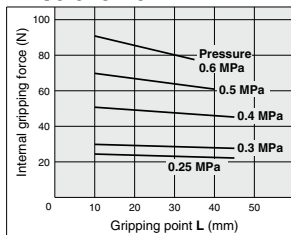

- MHZ
- MHF
- MHL
- MHR
- MHK
- MHS
- MHC
- MHT
- MHY
- MHW
- X
- MRHQ
- MA
- D-

MHS3 Series

Dimensions

MHS3-16S-X84: Single acting/Normally open

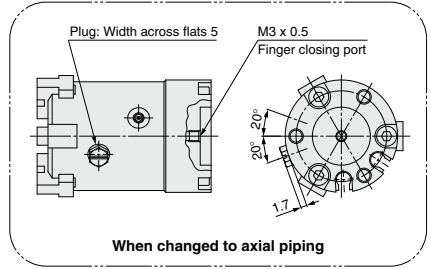
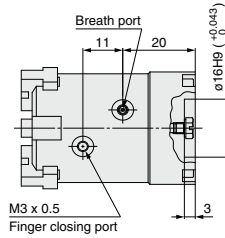

3 x $\phi 3.3$ through 6.5 counterbore depth 8
P.C.D. 25 (Mounting hole)

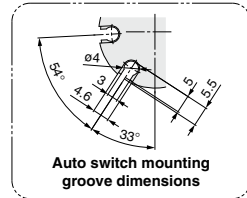
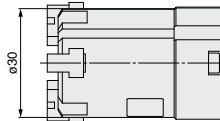
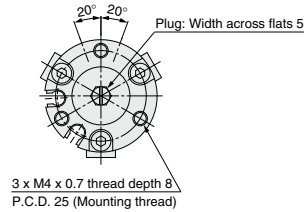
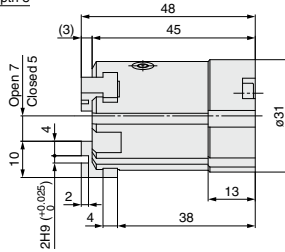
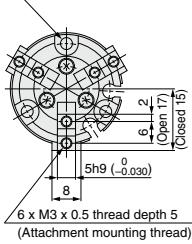

Dimensions

MHS3-20S/25S-X84: Single acting/Normally open

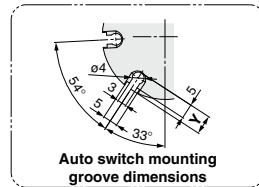
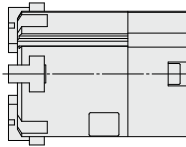
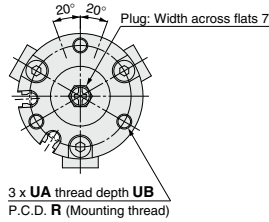
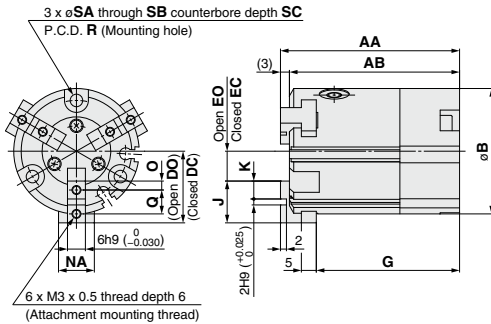
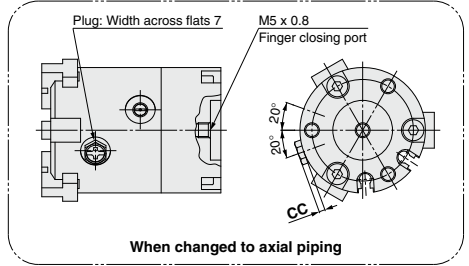
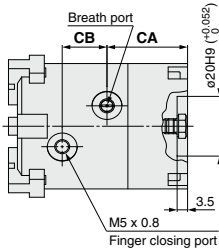

- MHZ
- MHF
- MHL
- MHR
- MHK
- MHS**
- MHC
- MHT
- MHY
- MHW
- X□
- MRHQ
- MA
- D-□

(mm)

Model	AA	AB	B	CA	CB	CC	DC	DO	EC	EO	G	J	K
MHS3-20S-X84	55	52	36	24	13	2.2	18	20	6	8	44	12	5
MHS3-25S-X84	60	57	42	27	15	2	21	24	7	10	48	14	6
Model	NA	O	Q	R	SA	SB	SC	UA	UB	Y			
MHS3-20S-X84	10	2.5	7	29	3.3	6.5	9.5	M4 x 0.7	8	6			
MHS3-25S-X84	12	3	8	34	4.2	8	10	M5 x 0.8	10	6.5			

MHS3 Series

Dimensions

MHS3-32s to 63S-X84: Single acting/Normally open

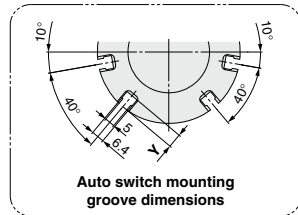
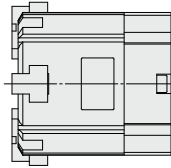
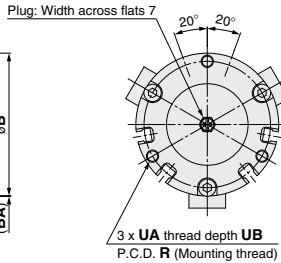
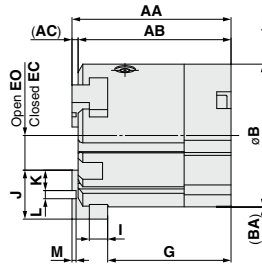
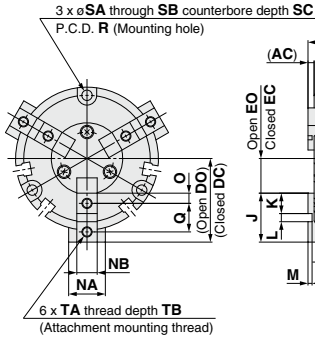
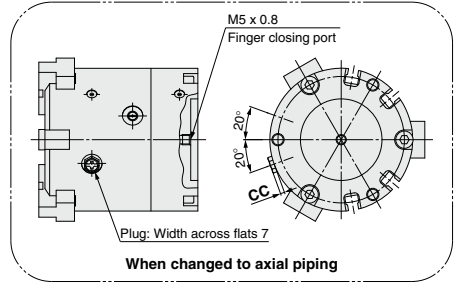
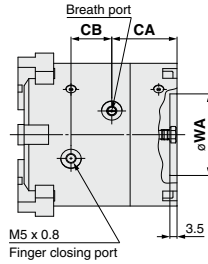

Model	AA	AB	AC	B	BA	CA	CB	CC	DC	DO	EC	EO	G	I	J	K	L
MHS3-32S-X84	66	63	3	52	—	30	16	2.2	28	32	8	12	52.5	6	20	9	2H9 (+0.025/0)
MHS3-40S-X84	66	63	3	62	—	28	17	2	31	35	10	14	51	7	21	9	3H9 (+0.025/0)
MHS3-50S-X84	78	75	3	70	0.3	32	20	2	35	41	11	17	60.5	9	24	10	4H9 (+0.030/0)
MHS3-63S-X84	92	88	4	86	—	38	22	2	43	51	15	23	70	11	28	11	6H9 (+0.030/0)

Model	M	NA	NB	O	Q	R	SA	SB	SC	TA	TB	UA	UB	WA	Y
MHS3-32S-X84	2	14	8h9 (+0.036/0)	4.5	11	44	4.2	8	9	M4 x 0.7	8	M5 x 0.8	10	25H9 (+0.052/0)	6
MHS3-40S-X84	2	16	8h9 (+0.036/0)	4.5	12	53	5.1	9.5	9	M4 x 0.7	8	M6 x 1	12	30H9 (+0.052/0)	8
MHS3-50S-X84	2	18	10h9 (+0.036/0)	5	14	62	5.1	9.5	12	M5 x 0.8	10	M6 x 1	12	40H9 (+0.062/0)	7
MHS3-63S-X84	3	24	12h9 (+0.043/0)	5.5	17	76	6.6	11	14	M5 x 0.8	10	M8 x 1.25	16	50H9 (+0.062/0)	7.5

Dimensions

MHS3-16C-X84: Single acting/Normally closed

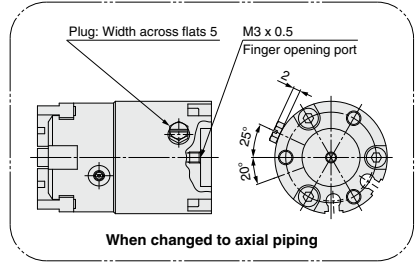
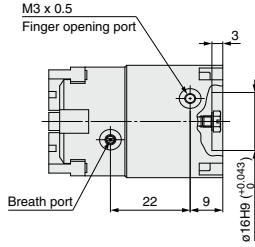

3 x $\phi 3.3$ through 6.5 counterbore depth 8
P.C.D. 25 (Mounting hole)

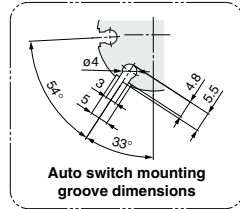
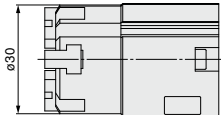
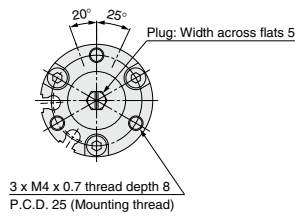
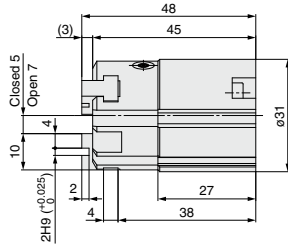
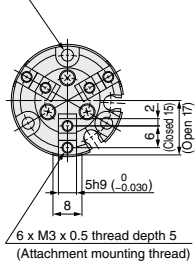

MHZ

MHF

MHL

MHR

MHK

MHS

MHC

MHT

MHY

MHW

-X□

MRHQ

MA

D-□

MHS3 Series

Dimensions

MHS3-20C/25C-X84: Single acting/Normally closed

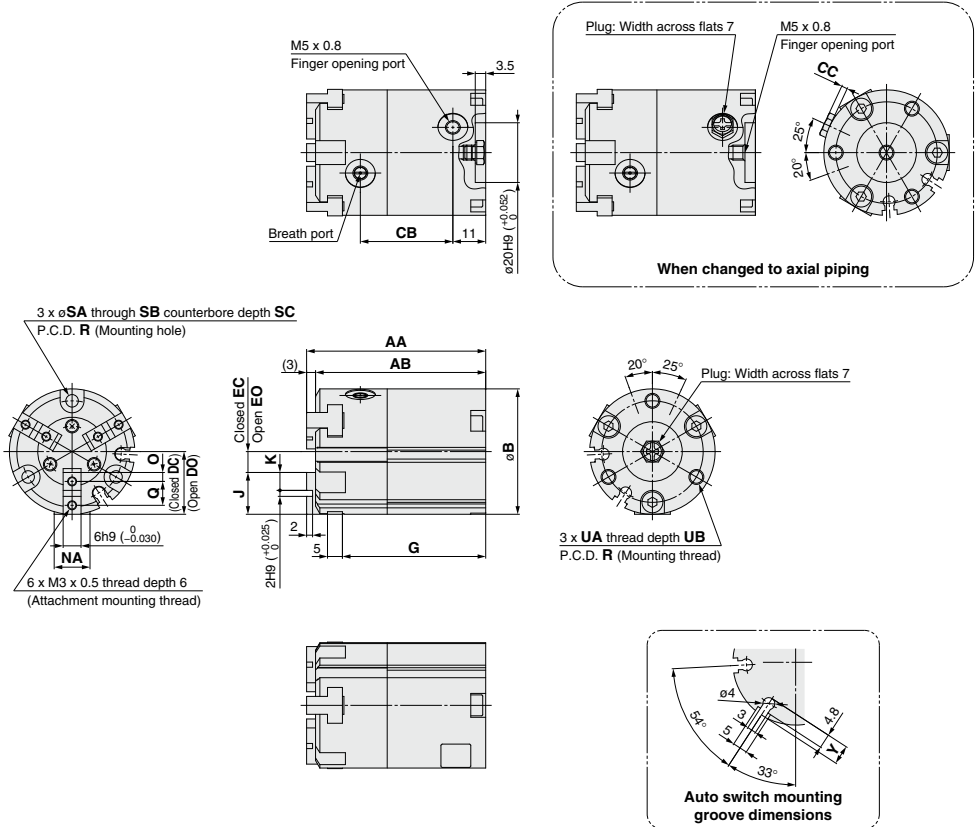

Model	AA	AB	B	CB	CC	DC	DO	EC	EO	G	J	K
MHS3-20C-X84	55	52	36	26	2.2	18	20	6	8	44	12	5
MHS3-25C-X84	60	57	42	31	2	21	24	7	10	48	14	6

Model	NA	O	Q	R	SA	SB	SC	UA	UB	Y
MHS3-20C-X84	10	2.5	7	29	3.3	6.5	9.5	M4 x 0.7	8	6
MHS3-25C-X84	12	3	8	34	4.2	8	10	M5 x 0.8	10	6.5

Dimensions

MHS3-32c to 63C-X84: Single acting/Normally closed

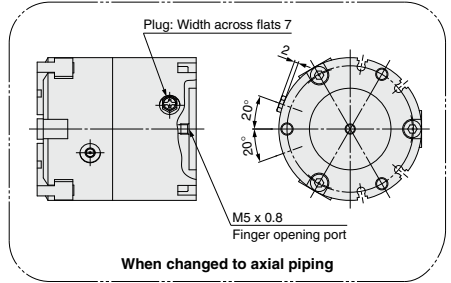
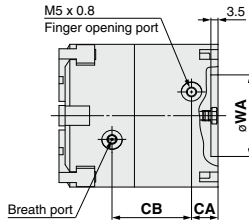

3 x øSA through SB counterbore depth SC
P.C.D. R (Mounting hole)

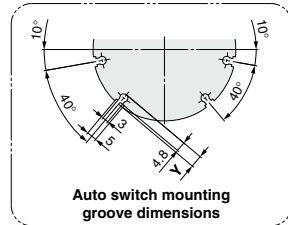
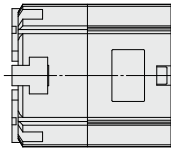
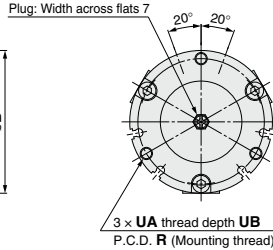
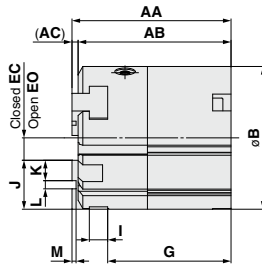
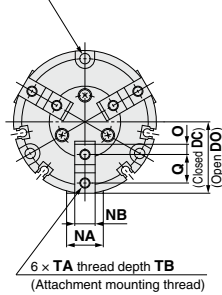

Model	AA	AB	AC	B	CA	CB	CC	DC	DO	EC	EO	G	I	J	K	L	M
MHS3-32C-X84	66	63	3	52	12	34	2.2	28	32	8	12	52.5	6	20	9	2H9 (+0.025/0)	2
MHS3-40C-X84	66	63	3	62	11	34	2	31	35	10	14	51	7	21	9	3H9 (+0.025/0)	2
MHS3-50C-X84	78	75	3	70	13	39	2	35	41	11	17	60.5	9	24	10	4H9 (+0.030/0)	2
MHS3-63C-X84	92	88	4	86	13	47	2	43	51	15	23	70	11	28	11	6H9 (+0.030/0)	3

Model	NA	NB	O	Q	R	SA	SB	SC	TA	TB	UA	UB	WA	Y
MHS3-32C-X84	14	8h9 (0/-0.036)	4.5	11	44	4.2	8	9	M4 x 0.7	8	M5 x 0.8	10	25H9 (+0.052/0)	5.7
MHS3-40C-X84	16	8h9 (0/-0.036)	4.5	12	53	5.1	9.5	9	M4 x 0.7	8	M6 x 1	12	30H9 (+0.052/0)	7.5
MHS3-50C-X84	18	10h9 (0/-0.036)	5	14	62	5.1	9.5	12	M5 x 0.8	10	M6 x 1	12	40H9 (+0.062/0)	6
MHS3-63C-X84	24	12h9 (0/-0.043)	5.5	17	76	6.6	11	14	M5 x 0.8	10	M8 x 1.25	16	50H9 (+0.062/0)	7

- MHZ
- MHF
- MHL
- MHR
- MHK
- MHS**
- MHC
- MHT
- MHY
- MHW
- X□
- MRHQ
- MA
- D-□

MHS3 Series

Protrusion of Auto Switch from Edge of Body

The projection of an auto switch from the edge of the body is shown in the table below. Use the table as a guideline for mounting.

(mm)

Direction of auto switch mounting on air gripper	Mounting with lead wire on side opposite the fingers				Mounting with lead wire on same side as the fingers			
	In-line entry		Perpendicular entry		In-line entry		Perpendicular entry	
Lead wire type Auto switch model Finger position Air gripper model	D-M9□ D-M9□W	D-M9□A	D-M9□V D-M9□WV	D-M9□AV	D-M9□ D-M9□W	D-M9□A	D-M9□V D-M9□WV	D-M9□AV
MHS3-16S-X84	Open	—	—	—	1	3	—	1
	Closed	—	—	—	—	—	—	—
MHS3-20S-X84	Open	—	—	—	—	—	—	—
	Closed	—	—	—	—	—	—	—
MHS3-25S-X84	Open	—	—	—	—	1	—	—
	Closed	—	—	—	—	—	—	—
MHS3-32S-X84	Open	—	—	—	—	—	—	—
	Closed	—	—	—	—	—	—	—
MHS3-40S-X84	Open	—	—	—	—	—	—	—
	Closed	—	—	—	—	—	—	—
MHS3-50S-X84	Open	—	—	—	—	—	—	—
	Closed	—	—	—	—	—	—	—
MHS3-63S-X84	Open	—	—	—	—	—	—	—
	Closed	—	—	—	—	—	—	—
MHS3-16C-X84	Open	—	—	—	—	—	—	—
	Closed	2.5	4.5	0.5	2.5	—	—	—
MHS3-20C-X84	Open	—	—	—	—	—	—	—
	Closed	—	2	—	—	—	—	—
MHS3-25C-X84	Open	—	—	—	—	—	—	—
	Closed	—	—	—	—	—	—	—
MHS3-32C-X84	Open	—	—	—	—	—	—	—
	Closed	—	0.5	—	—	—	—	—
MHS3-40C-X84	Open	—	—	—	—	—	—	—
	Closed	—	1	—	—	—	—	—
MHS3-50C-X84	Open	—	—	—	—	—	—	—
	Closed	—	—	—	—	—	—	—
MHS3-63C-X84	Open	—	—	—	—	—	—	—
	Closed	—	—	—	—	—	—	—

Note 1) There is no protrusion for sections of the table with no values entered.

Note 2) When mounted with lead wires on the finger side, be sure that attachments and workpieces, etc., do not touch switch units or lead wires.

Note 3) The actual mounting position should be adjusted after confirming the auto switch performance.



MHS Series Specific Product Precautions 1

Be sure to read this before handling the products.

Mounting Air Grippers/MHS Series

Possible to mount from 2 directions.

How to Mount Air Gripper

Body tapped

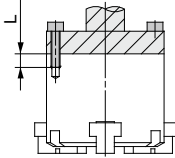

MHS2 Series

Model	Applicable bolts	Max. tightening torque N·m	Max. screw-in depth L mm
MHS2-16D	M4 x 0.7	2.1	8
MHS2-20D	M4 x 0.7	2.1	8
MHS2-25D	M4 x 0.7	2.1	8
MHS2-32D	M5 x 0.8	4.3	10
MHS2-40D	M6 x 1	7.3	12
MHS2-50D	M6 x 1	7.3	12
MHS2-63D	M6 x 1	7.3	12

MHS3, MHSL3 Series

Model	Applicable bolts	Max. tightening torque N·m	Max. screw-in depth L mm
MHS3 -16D MHSL3	M3 x 0.5	0.88	6
MHS3 -20D MHSL3	M3 x 0.5	0.88	6
MHS3 -25D MHSL3	M4 x 0.7	2.1	6
MHS3 -32D MHSL3	M4 x 0.7	2.1	6
MHS3 -40D MHSL3	M5 x 0.8	4.3	10
MHS3 -50D MHSL3	M5 x 0.8	4.3	10
MHS3 -63D MHSL3	M6 x 1	7.3	12
MHS3 -80D MHSL3	M6 x 1	7.3	12
MHS3 -100D MHSL3	M8 x 1.25	18	16
MHS3 -125D MHSL3	M10 x 1.5	36	20

MHS4 Series

Model	Applicable bolts	Max. tightening torque N·m	Max. screw-in depth L mm
MHS4-16D	M4 x 0.7	2.1	8
MHS4-20D	M4 x 0.7	2.1	8
MHS4-25D	M4 x 0.7	2.1	8
MHS4-32D	M5 x 0.8	4.3	10
MHS4-40D	M6 x 1	7.3	12
MHS4-50D	M6 x 1	7.3	12
MHS4-63D	M6 x 1	7.3	12

How to Mount Air Gripper

Body tapped

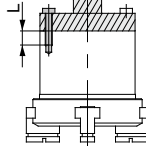

MHSJ3, MHS3 Series

Model	Applicable bolts	Max. tightening torque N·m	Max. screw-in depth L mm
MHSJ3 -16D MHS3	M4 x 0.7	2.1	8
MHSJ3 -20D MHS3	M4 x 0.7	2.1	8
MHSJ3 -25D MHS3	M4 x 0.7	2.1	8
MHSJ3 -32D MHS3	M4 x 0.7	2.1	8
MHSJ3 -32D MHS3	M5 x 0.8	3.2	10
MHSJ3 -40D MHS3	M4 x 0.7	2.1	8
MHSJ3 -40D MHS3	M5 x 0.8	3.2	10
MHSJ3 -50D MHS3	M5 x 0.8	3.2	10
MHSJ3 -50D MHS3	M6 x 1	7.3	12
MHSJ3 -63D MHS3	M6 x 1	7.3	12
MHSJ3 -63D MHS3	M8 x 1.25	18	16
MHSJ3 -80D MHS3	M6 x 1	7.3	12
MHSJ3 -80D MHS3	M8 x 1.25	18	16

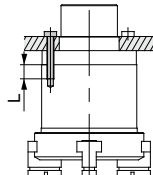

MHS3 Series (Center pusher)

Model	Applicable bolts	Max. tightening torque N·m	Max. screw-in depth L mm
MHS3-32DA MHS3-32DB	M5 x 0.8	3.2	10
MHS3-40DA MHS3-40DB	M5 x 0.8	3.2	10
MHS3-50DA MHS3-50DB	M6 x 1	7.3	12
MHS3-63DA MHS3-63DB	M8 x 1.25	18	16
MHS3-80DA MHS3-80DB	M8 x 1.25	18	16

Body through-hole

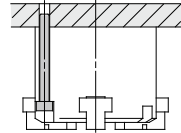

MHS2 Series

Model	Applicable bolts	Max. tightening torque N·m
MHS2-16D	M3 x 0.5	0.88
MHS2-20D	M3 x 0.5	0.88
MHS2-25D	M3 x 0.5	0.88
MHS2-32D	M4 x 0.7	2.1
MHS2-40D	M5 x 0.8	4.3
MHS2-50D	M5 x 0.8	4.3
MHS2-63D	M5 x 0.8	4.3

MHS3, MHSL3 Series

Model	Applicable bolts	Max. tightening torque N·m
MHS3 -16D MHSL3	M3 x 0.5	0.88
MHS3 -20D MHSL3	M3 x 0.5	0.88
MHS3 -25D MHSL3	M4 x 0.7	2.1
MHS3 -32D MHSL3	M4 x 0.7	2.1
MHS3 -40D MHSL3	M5 x 0.8	4.3
MHS3 -50D MHSL3	M5 x 0.8	4.3
MHS3 -63D MHSL3	M6 x 1	7.3
MHS3 -80D MHSL3	M6 x 1	7.3
MHS3 -100D MHSL3	M8 x 1.25	18
MHS3 -125D MHSL3	M10 x 1.5	36

MHS4 Series

Model	Applicable bolts	Max. tightening torque N·m
MHS4-16D	M3 x 0.5	0.88
MHS4-20D	M3 x 0.5	0.88
MHS4-25D	M3 x 0.5	0.88
MHS4-32D	M4 x 0.7	2.1
MHS4-40D	M5 x 0.8	4.3
MHS4-50D	M5 x 0.8	4.3
MHS4-63D	M5 x 0.8	4.3

MHZ

MHF

MHL

MHR

MHK

MHS

MHC

MHT

MHY

MHW

-X□

MRHQ

MA

D-□



MHS Series Specific Product Precautions 2

Be sure to read this before handling the products.

Mounting Air Grippers/MHS Series

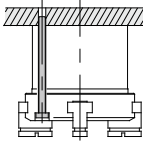

MHSJ3, MSH3 Series

Model	Applicable bolts	Max. tightening torque N·m
MHSJ3-16D MSH3	M3 x 0.5	0.88
MHSJ3-20D MSH3	M3 x 0.5	0.88
MHSJ3-25D MSH3	M3 x 0.5	0.88
MHSJ3-32D MSH3	M4 x 0.7	2.1
MHSJ3-40D MSH3	M4 x 0.7	2.1
MHSJ3-50D MSH3	M5 x 0.8	4.3
MHSJ3-63D MSH3	M6 x 1	7.3
MHSJ3-80D MSH3	M6 x 1	7.3

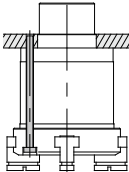

MHSH Series (Center pusher)

Model	Applicable bolts	Max. tightening torque N·m
MHSH3-32DA MHSH3-32DB	M4 x 0.7	2.1
MHSH3-40DA MHSH3-40DB	M4 x 0.7	2.1
MHSH3-50DA MHSH3-50DB	M5 x 0.8	4.3
MHSH3-63DA MHSH3-63DB	M6 x 1	7.3
MHSH3-80DA MHSH3-80DB	M6 x 1	7.3

Note) When using the through-holes to mount models MHSJ3 and MSHJ3, first remove the dust cover from the product, and after screwing it into place, reinstall the dust cover.

How to Mount the Attachment to the Finger

Make sure to mount the attachments on fingers with the tightening torque in the table below by using bolts, etc., for the female threads on fingers.

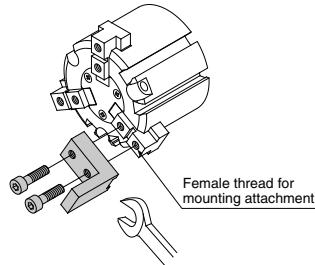

Model	Applicable bolts	Max. tightening torque N·m
MHS□-16D MHSJ3-20D MSH3-25D	M3 x 0.5	0.59
MHSL3-32D MHSL3-40D	M4 x 0.7	1.4
MHSL3-50D MHSL3-63D	M5 x 0.8	2.8
MHSL3-80D	M6 x 1	4.8
MHSL3-100D	M8 x 1.25	12
MHSL3-125D	M10 x 1.5	24