

For Food Industry

EHEDG Compliant/Clean Design/ FDA Compliant Fittings

New

RoHS

■ Hygienic design prevents liquid from accumulating after cleaning

■ FDA compliant materials

EHEDG Compliant Fittings

p. 7

EHEDG Compliant

IP69K

Hygienic Design

FDA Compliant

Stainless Steel 316 Insert Fittings

KFG2H□-E Series



Clean Design Fittings

p. 11

Hygienic Design

FDA Compliant

Stainless Steel 316 Insert Fittings

KFG2H□-C Series



FDA Compliant Fittings

p. 15

FDA Compliant

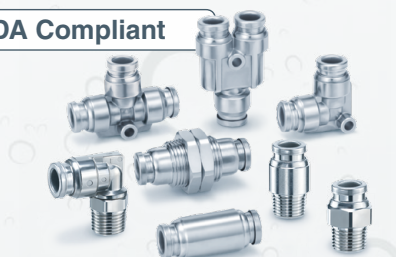

Stainless Steel 316 One-touch Fittings

KQG2-F Series



Metal One-touch Fittings

KQB2-F Series

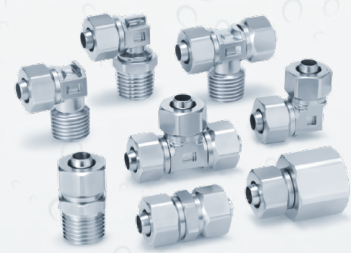

Stainless Steel 316 Insert Fittings

KFG2-F Series

KFG2H-E/KFG2H-C/KQ_B2-F KFG2-F Series



CAT.ES50-41A

EHEDG Compliant Fittings

EHEDG Compliant

IP69K

Hygienic Design

FDA Compliant

KFG2H□-E Series

p. 7



EHEDG Certification

This series satisfies EHEDG guidelines (hygienic design standards), preventing liquid and foreign matter from entering, and is easy to wash.

Design for less residual liquid accumulation

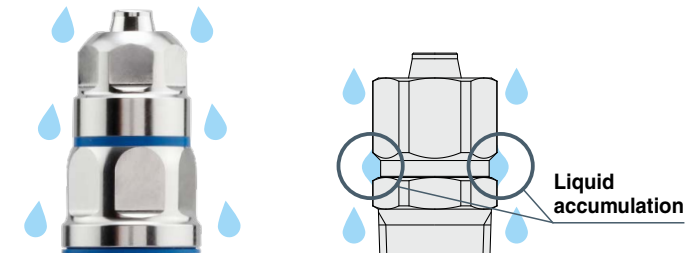

EHEDG compliant fitting

Design for better liquid flow and less residual liquid accumulation

Existing KFG2 model

Design for poor liquid flow and more residual liquid accumulation

Achieved IP69K rating

Rubber parts

The material used is a special FKM that is compliant with the Food and Drug Administration (FDA) §177.2600. They are colored in blue for superior visibility.

Body type: Male connector

Connection thread: M, G^{*1}

*1 ISO 16030 compliant

Fluid temperature

-5 to 150°C

EHEDG design standards

- 1 External surface roughness: Ra 0.8 µm or less
- 2 Corners of radius 3 mm or more or with an internal angle of 135°
- 3 Stainless material with high anti-corrosion performance: Stainless steel 316
- 4 No direct contact of external metal parts
- 5 Gasket seals made of FDA-compliant rubber materials



EHEDG Certificate of Compliance

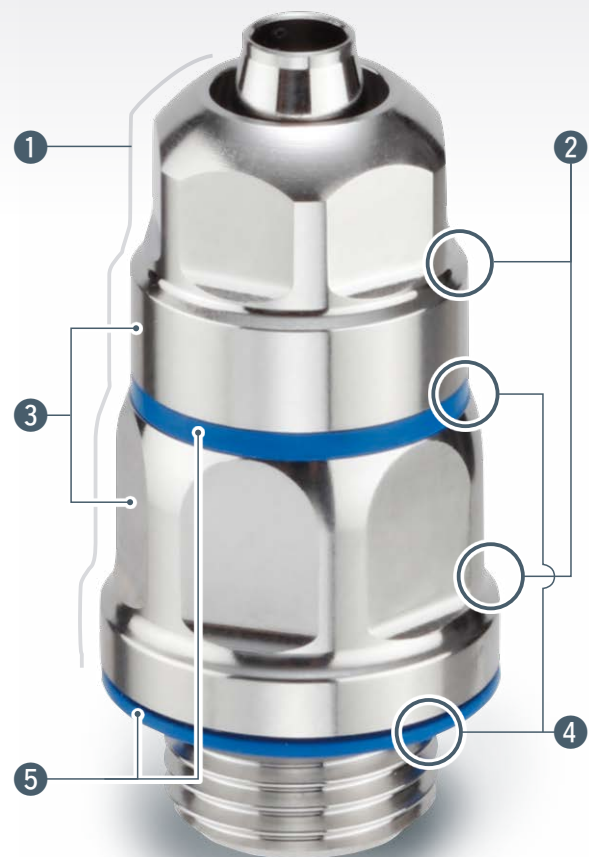

Clean Design Fittings

Hygienic
DesignFDA
Compliant

KFG2H□-C Series

p. 11

Design for less residual liquid accumulation



Clean design fitting
Rounded design for less residual liquid accumulation

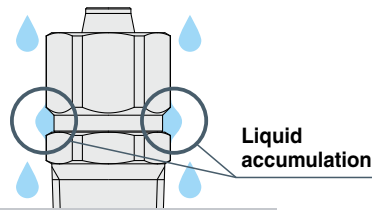

Existing KFG2 model
Design for poor liquid flow and more residual liquid accumulation

Metal parts: Stainless steel 316

Rubber parts

The material used is a special FKM that is compliant with the Food and Drug Administration (FDA) §177.2600. They are colored in blue for superior visibility.

Body type: Male connector

Connection thread: M, G^{*1}

*1 ISO 16030 compliant

Fluid temperature

-5 to 150°C



FDA Compliant Fittings

FDA
Compliant

KQG2-F/KQB2-F/KFG2-F Series

p. 15

Rubber parts

The material used is a special FKM that is compliant with the Food and Drug Administration (FDA) §177.2600.

Grease

NSF H1-compliant paraffin grease is used.

Stainless Steel 316 One-touch Fittings

KQG2-F Series

Applicable tubing: Metric size

Connection thread: M, R, Rc, UNF, NPT, G*¹

*1 ISO 16030 compliant



Metal One-touch Fittings

KQB2-F Series

Applicable tubing: Metric size

Connection thread: M, R, Rc, UNF, NPT, G*¹

*1 ISO 16030 compliant



Stainless Steel 316 Insert Fittings

KFG2-F Series

Applicable tubing: Metric size

Connection thread: R, Rc, NPT, G*¹, *²

*1 Swivel elbow only

*2 ISO 16030 compliant



FDA (U.S. Food and Drug Administration) Compliant Tubing

Polyurethane Tubing

TU-X214



- Complies with the FDA (U.S. Food and Drug Administration) § 177.2600 dissolution test
- Complies with the EU No 10/2011 dissolution test
- Max. operating pressure: 0.8 MPa (at 20°C)

Tubing O.D.		Color	Fluid
Metric size	Inch size		
ø4, ø6, ø8, ø10, ø12		Black, White, Red, Blue, Yellow, Green, Clear, Orange	Air, Water

Fluoropolymer Tubing

TL/TIL



- Complies with the FDA (U.S. Food and Drug Administration) § 177.1550 dissolution test
- Food Sanitation Law compliant*¹
- Max. operating pressure: 1.0 MPa (at 20°C)
- Operating temperature (Fixed usage): -65 to 260°C

Tubing O.D.		Color
Metric size	Inch size	
ø4, ø6, ø8, ø10, ø12, ø19	ø1/8", ø3/16", ø1/4", ø3/8", ø1/2", ø3/4", ø1"	Translucent

Fluoropolymer Tubing (PFA)

TLM/TILM

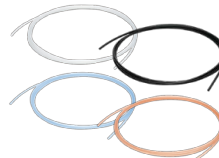

- Complies with the FDA (U.S. Food and Drug Administration) § 177.1550 dissolution test
- Food Sanitation Law compliant*¹
- Operating temperature (Fixed usage):
Air, Inert gas: -65 to 260°C
Water: 0 to 100°C (No freezing)

Tubing O.D.		Color
Metric size	Inch size	
ø2, ø3, ø4, ø6, ø8, ø10, ø12, ø16, ø19, ø25	ø1/8", ø3/16", ø1/4", ø3/8", ø1/2", ø3/4", ø1", ø1 1/4"	Translucent, Black, Red, Blue

FEP Tubing (Fluoropolymer)

TH/TH



- Complies with the FDA (U.S. Food and Drug Administration) § 177.1550 dissolution test
- Food Sanitation Law compliant*¹
- Max. operating pressure: 2.3 MPa (at 20°C)*²
*² This may vary according to size.
- Operating temperature (Fixed usage):
Air, Inert gas: -65 to 200°C
Water: 0 to 100°C (No freezing)
- Longer length reel (500 m): -X64

Tubing O.D.		Color
Metric size	Inch size	
ø4, ø6, ø8, ø10, ø12	ø1/8", ø3/16", ø1/4", ø3/8", ø1/2", ø3/4"	Translucent, Black, Red, Blue

Soft Fluoropolymer Tubing

TD/TID



- Complies with the FDA (U.S. Food and Drug Administration) § 177.1550 dissolution test
- Food Sanitation Law compliant*¹
- Max. operating pressure: 1.6 MPa (at 20°C)*²
*² This may vary according to size.
- Operating temperature (Fixed usage):
Air, Inert gas: -65 to 260°C
Water: 0 to 100°C (No freezing)

Tubing O.D.		Color
Metric size	Inch size	
ø4, ø6, ø8, ø10, ø12	ø1/8", ø3/16", ø1/4", ø3/8", ø1/2"	Translucent

Polyolefin Tubing

TPH



- Complies with the FDA (U.S. Food and Drug Administration) § 175.300 dissolution test
- Max. operating pressure (at 20°C): 1.0 MPa (ø4, ø6), 0.7 MPa (ø8, ø10, ø12)
- Longer length reel (500 m): -X40

Applicable tubing O.D.	Color	Fluid
ø4, ø6, ø8, ø10, ø12	White, Blue, Yellow	Air, Water, etc.

Soft Polyolefin Tubing

TPS



- Complies with the FDA (U.S. Food and Drug Administration) § 175.300 dissolution test
- Max. operating pressure (at 20°C): 0.7 MPa (ø4 to ø12)

Applicable tubing O.D.	Color	Fluid
ø4, ø6, ø8, ø10, ø12	White, Blue, Yellow	Air, Water, etc.

*¹ Testing in compliance with Japan's Food Sanitation Law based on the 370th notice given by the Ministry of Health and Welfare in 1959

EHEDG Compliant Fittings

p. 7

Stainless Steel 316 Insert Fittings

KFG2H□-E Series



Applicable Tubing Metric Size

Connection Thread M, G

Applicable Tubing..... p. 7
 Specifications..... p. 7
 Construction..... p. 7
 Dimensions..... p. 8
 Specific Product Precautions..... p. 9

Clean Design Fittings

p. 11

Stainless Steel 316 Insert Fittings

KFG2H□-C Series



Applicable Tubing Metric Size

Connection Thread M, G

Applicable Tubing..... p. 11
 Specifications..... p. 11
 Construction..... p. 11
 Dimensions..... p. 12
 Specific Product Precautions..... p. 13

FDA Compliant Fittings

p. 15

Stainless Steel 316 One-touch Fittings

KQG2-F Series



Applicable Tubing Metric Size

Connection Thread M, R, Rc

Applicable Tubing..... p. 16
 Specifications..... p. 16
 How to Order..... p. 17
 Construction..... p. 17
 Dimensions..... p. 18



Applicable Tubing Inch Size

Connection Thread UNF, NPT

Applicable Tubing..... p. 23
 Specifications..... p. 23
 How to Order..... p. 24
 Construction..... p. 24
 Dimensions..... p. 25



Applicable Tubing Metric Size

Connection Thread G

Applicable Tubing..... p. 30
 Specifications..... p. 30
 How to Order..... p. 31
 Construction..... p. 31
 Dimensions..... p. 32

Specific Product Precautions..... p. 35

FDA Compliant Fittings

p. 36

Metal One-touch Fittings
KQB2-F Series



Applicable Tubing Metric Size

Connection Thread M, R, Rc

Applicable Tubing..... p. 37
 Specifications..... p. 37
 How to Order..... p. 38
 Construction..... p. 38
 Dimensions..... p. 39



Applicable Tubing Inch Size

Connection Thread UNF, NPT

Applicable Tubing..... p. 45
 Specifications..... p. 45
 How to Order..... p. 46
 Construction..... p. 46
 Dimensions..... p. 47



Applicable Tubing Metric Size

Connection Thread G

Applicable Tubing..... p. 52
 Specifications..... p. 52
 How to Order..... p. 53
 Construction..... p. 53
 Dimensions..... p. 54

 Specific Product Precautions..... p. 57

FDA Compliant Fittings

p. 58

Stainless Steel 316 Insert Fittings
KFG2-F Series



Applicable Tubing Metric Size

Connection Thread R, Rc

Applicable Tubing..... p. 59
 Specifications..... p. 59
 How to Order..... p. 60
 Construction..... p. 60
 Dimensions..... p. 61



Applicable Tubing Inch Size

Connection Thread NPT

Applicable Tubing..... p. 65
 Specifications..... p. 65
 How to Order..... p. 66
 Construction..... p. 66
 Dimensions..... p. 67



Applicable Tubing Metric Size

Connection Thread G

Applicable Tubing..... p. 70
 Specifications..... p. 70
 How to Order..... p. 71
 Construction..... p. 71
 Dimensions..... p. 72

 Specific Product Precautions..... p. 73

Fittings & Tubing Precautions..... p. 75

EHEDG
Compliant

Metric M, G
KFG2H□-E

Clean
Design

Metric M, G
KFG2H□-C

FDA
Compliant

Metric M, R, Rc
KQG2-F

Inch UNF, NPT
KQG2-F

Metric G
KQG2-F

Metric M, R, Rc
KQB2-F

Inch UNF, NPT
KQB2-F

Metric G
KQB2-F

Metric R, Rc
KFG2-F

Inch NPT
KFG2-F

Metric G
KFG2-F

Precautions

Stainless Steel 316 Insert Fittings

Applicable Tubing: Metric Size, Connection Thread: M, G*1

*1 ISO 16030 compliant

KFG2H□-E Series



- IP69K
 - Special FKM compliant with the Food and Drug Administration (FDA)
- \$177.2600**

Applicable Tubing

Tubing material*1,*2	FEP, PFA, Modified PTFE, 2-layer soft fluoropolymer, Nylon, Soft nylon, Polyurethane, Soft polyurethane, Polyolefin, Soft polyolefin, Antistatic soft nylon, Antistatic polyurethane, Hard polyurethane
Tubing size	ø4 x ø2.5, ø6 x ø4, ø8 x ø6, ø10 x ø7.5, ø12 x ø9

*1 Considering the product application, FDA-compliant products are recommended.

*2 For soft polyurethane tubing, hard polyurethane tubing, and antistatic polyurethane tubing, water cannot be used.

Series	Tubing material	Tubing O.D. x I.D. [mm]				
		ø4 x ø2.5	ø6 x ø4	ø8 x ø6	ø10 x ø7.5	ø12 x ø9
TH	FEP*1	●	●	●	●	●
TL	Super PFA*1	—	●	●	—	—
TLM	PFA*1	●	●	●	●	●
TD	Modified PTFE*1	●	●	●	●	●
TQ	Special fluoropolymer	●	●	●	—	●
T	Nylon	●	●	●	●	●
TS	Soft nylon	●	●	●	●	●
TU	Polyurethane	●	●	—	—	—
TU-X214	Polyurethane*1	●	●	—	—	—
TPH	Polyolefin*1	●	●	●	●	●
TUS	Soft polyurethane	●	●	—	—	—
TUH	Hard polyurethane (High pressure)	●	●	—	—	—
TPS	Soft polyolefin*1	●	●	—	—	—
TAS	Antistatic soft nylon	●	●	—	—	—
TAU	Antistatic polyurethane	●	●	—	—	—

*1 FDA compliant tubing (Refer to page 4.)

Spare Parts

Description	Part no.	Applicable thread	Material
Gasket (G thread side)	KFG2-M5-E	M5	FDA compliant FKM
	KFG2-G01-E	G1/8	
	KFG2-G02-E	G1/4	
	KFG2-G03-E	G3/8	
	KFG2-G04-E	G1/2	

Specifications

Fluid	Air, Water*1, Steam*3
Operating pressure range*2	-100 kPa to 1 MPa*4
Ambient and fluid temperatures	-5 to 150°C (No freezing)*4

*1 Deionized water is not recommended for use as it may affect the material used in the fittings. In addition, it is known to degrade the water quality.

*2 Do not use the fittings with a leak tester or for vacuum retention because they are not guaranteed for zero leakage.

*3 Please contact SMC for applicable tubing separately.

*4 Check the operating pressure range and operating temperature range of the tubing.

Construction

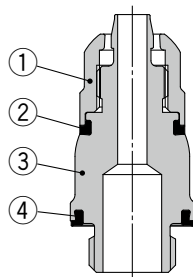

Principal Parts Material

No.	Description	Material	Note
1	Union nut	Stainless steel 316	NSF H1 grease
2	Gasket	FDA compliant FKM	
3	Male connector body	Stainless steel 316	
4	Gasket	FDA compliant FKM	

Stainless Steel 316 Insert Fittings **KFG2H□-E Series**

Applicable Tubing: Metric Size, Connection Thread: M, G

Dimensions

Male Connector: KFG2H□-E



Applicable tubing size [mm]		Connection thread	Model	Width across flats		L	M	ød1	ød2	A	Effective area [mm²]	Weight [g]
O.D.	I.D.			H1	H2							
ø4	ø2.5	M5 x 0.8	KFG2H0425-M5-E	8	7	23.3	5	1.8	8.8	19.8	1.6	7
ø6	ø4	G1/8	KFG2H0604-G01-E	12	10	29	5.8	3.3	14	23.5	6	17
ø8	ø6	G1/4	KFG2H0806-G02-E	14	12	33.6	6.6	5.3	18	27.1	17	25
ø10	ø7.5	G3/8	KFG2H1075-G03-E	17	14	38.1	7.6	6.8	21.8	30.6	30	38
ø12	ø9	G1/2	KFG2H1209-G04-E	19	17	43.2	8.5	8	26	34.2	45	58

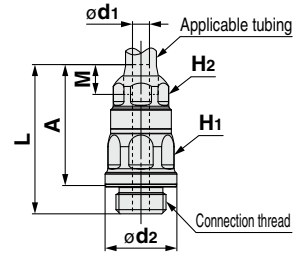

EHEDG Compliant

Metric M, G
KFG2H□-E

Clean Design

Metric M, G
KFG2H□-C

FDA Compliant

Metric M, R, Rc
KQG2-F

Inch UNF, NPT
KQG2-F

Metric G
KQG2-F

Metric M, R, Rc
KQB2-F

Inch UNF, NPT
KQB2-F

Metric G
KQB2-F

Metric R, Rc
KFG2-F

Inch NPT
KFG2-F

Metric G
KFG2-F

Precautions



Design/Selection

Warning

1. Confirm the specifications.

Do not use beverages or food as operating fluid used inside the product. The design of this product is not intended to use beverages or food as operating fluid.

Caution

1. This product is not sterilized. The product should be cleaned and sterilized before use.

Mounting/Piping

Warning

1. Cleaning space

Allow space for cleaning when piping. Connect the fitting so that it can be cleaned from all directions. If more than one fitting is installed, or if the fitting is installed near the wall, keep at least 6 mm of clearance.

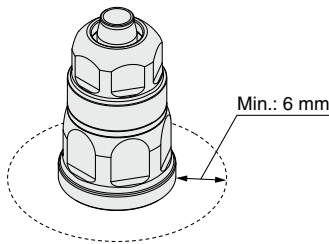

Caution

1. Use a tool with a soft internal surface, such as plastic, to prevent damage to the fitting surface.

Otherwise, the fitting surface may be damaged. After mounting, check that the fitting is not damaged.

2. If mounting the product from above, incline the mounting surface so that water and detergent do not accumulate in the fitting.

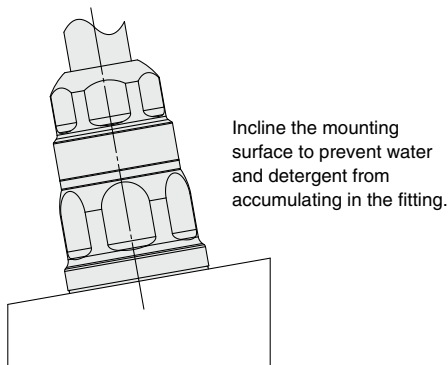

Piping

Caution

1. Cut the tubing perpendicularly, being careful not to damage the outside surface. Use an SMC tube cutter TK-1, 2, 3, 5, or 6. Do not cut the tubing with pliers, nippers, scissors, etc. The tube might be cut diagonally or flattened, making installation impossible or causing problems such as disconnection and leakage.

2. Insert the tube into the union nut with the union nut removed. Grab the tube and gently push it thoroughly into the fitting.

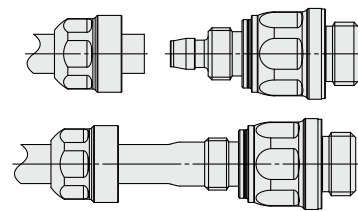

3. After insertion, tighten the union nut temporarily by hand.

4. Fix the body with a tool. Tighten the union nut to the end surface of the body using a suitable wrench.

Hexagon across flats may be deformed, if using an improper wrench for hexagon across flats. If the body is not secured with a tool, this may cause breakage.

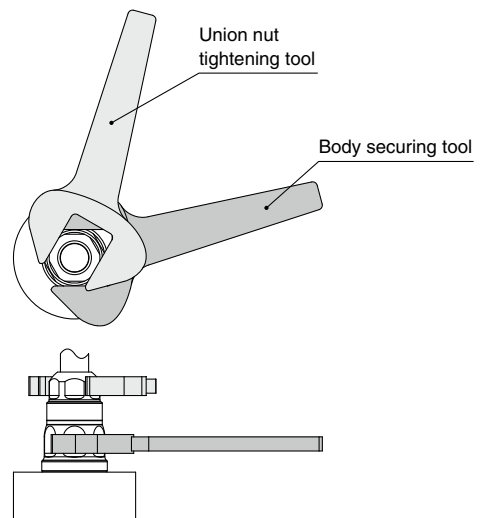

5. Fix the body with a tightening tool. Tighten the union nut to the end surface of the body with the proper tightening torque using a suitable wrench.

Hexagon across flats may be deformed, if using an improper wrench for hexagon across flats. Tighten the union nut with the proper tightening torque shown below.

Union nut tightening direction

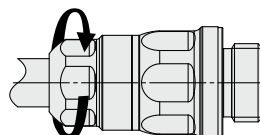

Fitting size	Proper tightening torque [N·m]
KFG2□04	2 to 3
KFG2□06	3 to 4
KFG2□08	5 to 6
KFG2□10	8 to 10
KFG2□12	10 to 12

**Cleaning Method****Warning****1. Check the connection before cleaning.**

Clean the fittings whilst connected to the product. Do not clean the fitting when the tube, union nut, and body are not assembled.

2. Review the conditions before cleaning.

Make sure that the fitting material is not affected or damaged by chemical solution, temperature, and water pressure before use.

3. Do not use a metal brush or tool that may damage or scratch the fitting.**Maintenance****Caution****1. Pre-maintenance inspection**

When the product is removed, turn off the power, cut off the supply pressure, and confirm that fluid in the piping has been discharged.

2. During regular maintenance, check for the following and replace any components as necessary.

- a) Scratches, gouges, abrasion, corrosion
- b) Leakage
- c) Flattening or distortion of the tube
- d) Hardening, deterioration or softness of the tube
- e) Loosening of the union nut

3. Do not repair the fittings or patch the tube for reuse.**4. After operation at a high temperature, leakage may occur due to time dependent change of the tube material. If leakage occurs, remove the tube, cut off the connecting part of the tube, and connect to the piping again.**

Check if the tube dimension accuracy is within the recommended tolerance. If it is difficult to take the tube out of the body, bend the tube to the side to remove.

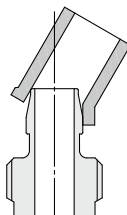
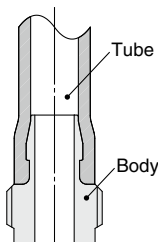
**Connection Thread Tightening Method****Caution****1. First, tighten the fitting by hand, then use a suitable wrench to tighten the hexagonal portion of the body. To find the appropriate tightening torque, refer to the table below.**

If tightened using a torque exceeding the proper torque level, this may cause the fitting to break.

Connection thread size	Proper tightening torque [N·m]
M5	1 to 1.5
G1/8	3 to 5
G1/4	8 to 12
G3/8	15 to 20
G1/2	20 to 25

2. Insufficient tightening may cause seal failure or loosen the threads.**Other Tubing Brands****Caution****1. When used with tubing other than those from SMC, due to its properties, the KFG2 series is not subject to warranty.****Stainless steel**

Metal exists in nature as ore (like oxide or sulfide). This means that oxide or sulfide is more stable than pure metal. Accordingly, metallic material chemically oxidizes (metallic constituent becomes ion and melts out). It corrodes in the natural environment.

Even though corrosion of metal easily occurs in an environment where oxidizing tendency is stronger, some kinds of metal have a characteristic for which corrosion never happens if the level of oxidizing goes higher than a specific point. In such a case, it is called "metal in passive state".

Stainless steel has corrosion resistance because of a thin coat of passive state on its surface. However, there does not exist stainless steel with absolute corrosion resistance; therefore, many types of stainless steel have been developed for improved corrosion resistance performance.

Stainless Steel 316 Insert Fittings

Applicable Tubing: Metric Size, Connection Thread: M, G*1

*1 ISO 16030 compliant

KFG2H□-C Series



• Special FKM compliant with the Food and Drug Administration (FDA)
\$177.2600

Applicable Tubing

Tubing material*1,*2	FEP, PFA, Modified PTFE, 2-layer soft fluoropolymer, Nylon, Soft nylon, Polyurethane, Soft polyurethane, Polyolefin, Soft polyolefin, Antistatic soft nylon, Antistatic polyurethane, Hard polyurethane
Tubing size	ø4 x ø2.5, ø6 x ø4, ø8 x ø6, ø10 x ø7.5, ø12 x ø9

*1 Considering the product application, FDA-compliant products are recommended.

*2 For soft polyurethane tubing, hard polyurethane tubing, and antistatic polyurethane tubing, water cannot be used.

Series	Tubing material	Tubing O.D. x I.D. [mm]				
		ø4 x ø2.5	ø6 x ø4	ø8 x ø6	ø10 x ø7.5	ø12 x ø9
TH	FEP*1	●	●	●	●	●
TL	Super PFA*1	—	●	●	—	—
TLM	PFA*1	●	●	●	●	●
TD	Modified PTFE*1	●	●	●	●	●
TQ	Special fluoropolymer	●	●	●	—	●
T	Nylon	●	●	●	●	●
TS	Soft nylon	●	●	●	●	●
TU	Polyurethane	●	●	—	—	—
TU-X214	Polyurethane*1	●	●	—	—	—
TPH	Polyolefin*1	●	●	●	●	●
TUS	Soft polyurethane	●	●	—	—	—
TUH	Hard polyurethane (High pressure)	●	●	—	—	—
TPS	Soft polyolefin*1	●	●	—	—	—
TAS	Antistatic soft nylon	●	●	—	—	—
TAU	Antistatic polyurethane	●	●	—	—	—

*1 FDA compliant tubing (Refer to page 4.)

Spare Parts

Description	Part no.	Applicable thread	Material
Gasket (G thread side)	KFG2-M5-E	M5	FDA compliant FKM
	KFG2-G01-E	G1/8	
	KFG2-G02-E	G1/4	
	KFG2-G03-E	G3/8	
	KFG2-G04-E	G1/2	

Specifications

Fluid	Air, Water*1, Steam*3
Operating pressure range*2	-100 kPa to 1 MPa*4
Ambient and fluid temperatures	-5 to 150°C (No freezing)*4

*1 Deionized water is not recommended for use as it may affect the material used in the fittings. In addition, it is known to degrade the water quality.

*2 Do not use the fittings with a leak tester or for vacuum retention because they are not guaranteed for zero leakage.

*3 Please contact SMC for applicable tubing separately.

*4 Check the operating pressure range and operating temperature range of the tubing.

Construction

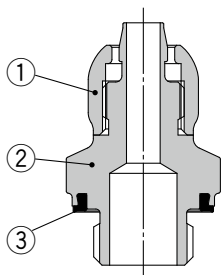

Principal Parts Material

No.	Description	Material	Note
1	Union nut	Stainless steel 316	NSF H1 grease
2	Male connector body	Stainless steel 316	
3	Gasket	FDA compliant FKM	

Stainless Steel 316 Insert Fittings **KFG2H□-C Series**

Applicable Tubing: Metric Size, Connection Thread: M, G

Dimensions

Male Connector: KFG2H□-C



Applicable tubing size [mm]		Connection thread	Model	Width across flats		L	M	ød1	ød2	A	Effective area [mm ²]	Weight [g]
O.D.	I.D.			H1	H2							
ø4	ø2.5	M5 x 0.8	KFG2H0425-M5-C	10	7	19.9	5	1.8	8.8	16.4	1.6	6
ø6	ø4	G1/8	KFG2H0604-G01-C	14	10	23.8	5.8	3.3	14	18.3	6	13
ø8	ø6	G1/4	KFG2H0806-G02-C	19	12	28	6.6	5.3	18	21.5	17	23
ø10	ø7.5	G3/8	KFG2H1075-G03-C	22	14	32.2	7.6	6.8	21.8	24.7	30	35
ø12	ø9	G1/2	KFG2H1209-G04-C	27	17	37.3	8.5	8	26	28.3	45	61

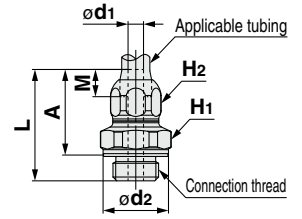

EHEDG
Compliant

Metric M, G
KFG2H□-E

Clean
Design

Metric M, G
KFG2H□-C

FDA
Compliant

Metric M, R, Rc
KQG2-F

Inch UNF, NPT
KQG2-F

Metric G
KQG2-F

Metric M, R, Rc
KQB2-F

Inch UNF, NPT
KQB2-F

Metric G
KQB2-F

Metric R, Rc
KFG2-F

Inch NPT
KFG2-F

Metric G
KFG2-F

Precautions



Clean Design Fittings

KFG2H□-C Series

Specific Product Precautions 1

Piping

⚠ Caution

1. Cut the tubing perpendicularly, being careful not to damage the outside surface.

Use an SMC tube cutter TK-1, 2, 3, 5, or 6. Do not cut the tubing with pliers, nippers, scissors, etc. The tube might be cut diagonally or flattened, making installation impossible or causing problems such as disconnection and leakage.

2. Insert the tube into the union nut with the union nut removed. Grab the tube and gently push it thoroughly into the fitting.

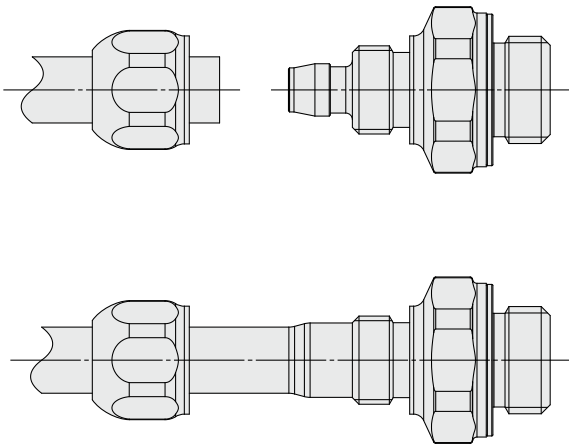

3. After insertion, tighten the union nut temporarily by hand.

4. Fix the body with a tool. Tighten the union nut to the end surface of the body using a suitable wrench.

Hexagon across flats may be deformed, if using an improper wrench for hexagon across flats. If the body is not secured with a tool, this may cause breakage.

⚠ Caution

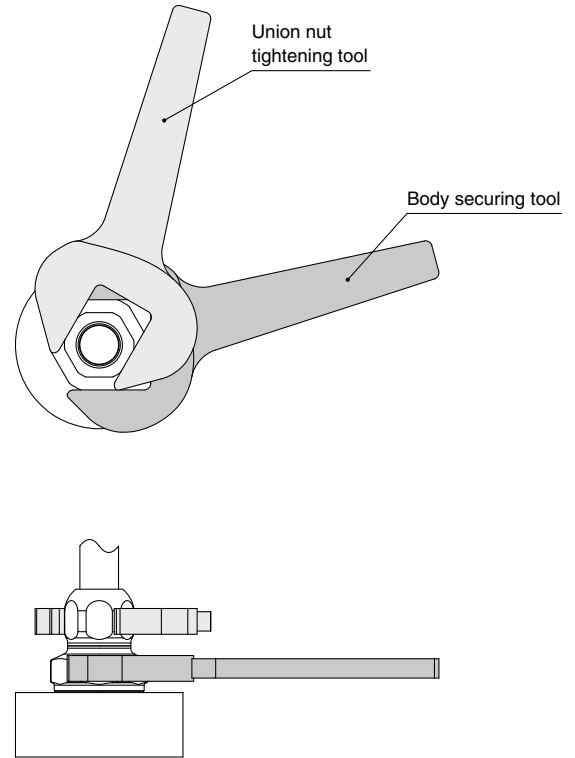

5. Fix the body with a tightening tool. Tighten the union nut to the end surface of the body with the proper tightening torque using a suitable wrench.

Hexagon across flats may be deformed, if using an improper wrench for hexagon across flats. Tighten the union nut with the proper tightening torque shown below.

Union nut tightening direction

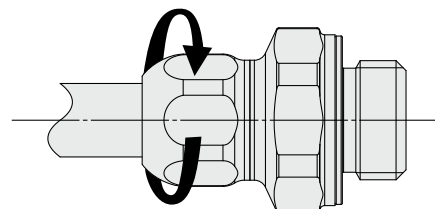

Fitting size	Proper tightening torque [N·m]
KFG2□04	2 to 3
KFG2□06	3 to 4
KFG2□08	5 to 6
KFG2□10	8 to 10
KFG2□12	10 to 12



Clean Design Fittings

KFG2H□-C Series

Specific Product Precautions 2

Cleaning Method

Warning

- 1. Check the connection before cleaning.**
Clean the fitting with the tube connected and the nut tightened. Do not clean the fitting when the tube, union nut, and body are not assembled.
- 2. Review the conditions before cleaning.**
Make sure that the fitting material is not affected or damaged by chemical solution, temperature, and water pressure before use.
- 3. Do not use a metal brush or tool that may damage or scratch the fitting.**

Maintenance

Caution

- 1. Pre-maintenance inspection**
When the product is removed, turn off the power, cut off the supply pressure, and confirm that fluid in the piping has been discharged.
- 2. During regular maintenance, check for the following and replace any components as necessary.**
 - Scratches, gouges, abrasion, corrosion
 - Leakage
 - Flattening or distortion of the tube
 - Hardening, deterioration or softness of the tube
 - Loosening of the union nut
- 3. Do not repair the fittings or patch the tube for reuse.**
- 4. After operation at a high temperature, leakage may occur due to time dependent change of the tube material. If leakage occurs, remove the tube, cut off the connecting part of the tube, and connect to the piping again.**
Check if the tube dimension accuracy is within the recommended tolerance. If it is difficult to take the tube out of the body, bend the tube to the side to remove.

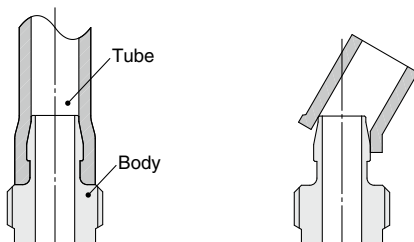

Connection Thread Tightening Method

Caution

- 1. First, tighten the fitting by hand, then use a suitable wrench to tighten the hexagonal portion of the body. To find the appropriate tightening torque, refer to the table below.**
If tightened using a torque exceeding the proper torque level, this may cause the fitting to break.

Connection thread size	Proper tightening torque [N·m]
M5	1 to 1.5
G1/8	3 to 5
G1/4	8 to 12
G3/8	15 to 20
G1/2	20 to 25

- 2. Insufficient tightening may cause seal failure or loosen the threads.**

Other Tubing Brands

Caution

- 1. When used with tubing other than those from SMC, due to its properties, the KFG2 series is not subject to warranty.**

Stainless steel

Metal exists in nature as ore (like oxide or sulfide). This means that oxide or sulfide is more stable than pure metal. Accordingly, metallic material chemically oxidizes (metallic constituent becomes ion and melts out). It corrodes in the natural environment.

Even though corrosion of metal easily occurs in an environment where oxidizing tendency is stronger, some kinds of metal have a characteristic for which corrosion never happens if the level of oxidizing goes higher than a specific point. In such a case, it is called "metal in passive state".

Stainless steel has corrosion resistance because of a thin coat of passive state on its surface. However, there does not exist stainless steel with absolute corrosion resistance; therefore, many types of stainless steel have been developed for improved corrosion resistance performance.

EHEDG
Compliant

Metric M, G
KFG2H□-E

Clean
Design

Metric M, G
KFG2H□-C

FDA
Compliant

Metric M, R, Rc
KQG2-F

Inch UNF, NPT
KQG2-F

Metric G
KQG2-F

Metric M, R, Rc
KQB2-F

Inch UNF, NPT
KQB2-F

Metric G
KQB2-F

Metric R, Rc
KFG2-F

Inch NPT
KFG2-F

Metric G
KFG2-F

Precautions

Variations

Male Connector **KQG2H**

Metric	R thread	p. 18
	G thread	p. 32
Inch		p. 25



Bulkhead Union **KQG2E**

Metric	p. 20
Inch	p. 27



Different Diameter Union "Y" **KQG2U**

Metric	p. 21
Inch	p. 28



Hexagon Socket Head Male Connector **KQG2S**

Metric	R thread	p. 18
	G thread	p. 32
Inch		p. 25



Union Tee **KQG2T**

Metric	p. 20
Inch	p. 27



Bulkhead Connector **KQG2E**

Metric	Rc thread	p. 21
	G thread	p. 34
Inch		p. 28

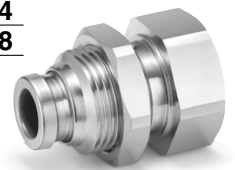

Straight Union **KQG2H**

Metric	p. 18
Inch	p. 25



Union "Y" **KQG2U**

Metric	p. 20
Inch	p. 27



Extended Male Elbow **KQG2W**

Metric	R thread	p. 22
	G thread	p. 34
Inch		p. 28



Male Elbow **KQG2L**

Metric	R thread	p. 19
	G thread	p. 33
Inch		p. 26



Different Diameter Tee **KQG2T**

Metric	p. 20
Inch	p. 27



Female Connector **KQG2F**

Metric	Rc thread	p. 22
	G thread	p. 34
Inch		p. 29

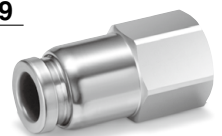

Male Branch Tee **KQG2T**

Metric	R thread	p. 19
	G thread	p. 33
Inch		p. 26



Plug-in Reducer **KQG2R**

Metric	p. 20
Inch	p. 27



Plug **KQG2P**

Metric	p. 22
Inch	p. 29



Union Elbow **KQG2L**

Metric	p. 19
Inch	p. 26



Different Diameter Straight **KQG2H**

Metric	p. 21
Inch	p. 28



Stainless Steel 316 One-touch Fittings

Applicable Tubing: Metric Size, Connection Thread: M, R, Rc

KQG2-F Series



EHEDG
Compliant

Metric M, G
KFG2H□-E

Clean
Design

Metric M, G
KFG2H□-C

FDA
Compliant

Metric M, R, Rc
KQG2-F

Inch UNF, NPT
KQG2-F

Metric G
KQG2-F

Metric M, R, Rc
KQB2-F

Inch UNF, NPT
KQB2-F

Metric G
KQB2-F

Metric R, Rc
KFG2-F

Inch NPT
KFG2-F

Metric G
KFG2-F

Precautions



Applicable Tubing

Tubing material*1	FEP, PFA, Nylon, Soft nylon, Polyurethane, Polyolefin
Tubing O.D.	ø3.2, ø4, ø6, ø8, ø10, ø12, ø16

*1 Considering the product application, FDA-compliant products are recommended.

Specifications

Fluid	Air, Water*1, Steam*2
Operating pressure range*3	-100 kPa to 1 MPa*4
Proof pressure	3.0 MPa
Ambient and fluid temperatures*5	-5 to 150°C (No freezing)*4
Lubricant	NSF H1 grease
Seal on the threads	Without sealant

*1 Deionized water is not recommended for use as it may affect the material used in the fittings. In addition, it is known to degrade the water quality.

*2 Please contact SMC for applicable tubing separately.

*3 Do not use the fittings with a leak tester or for vacuum retention because they are not guaranteed for zero leakage.

*4 Check the operating pressure range and operating temperature range of the tubing.

*5 It is recommended that you use the inner sleeve in the following conditions. (Except ø3.2)

- When using in an environment where the fluid temperature changes drastically
- When using at a high temperature

* Temperature Condition of Mounting the Inner Sleeve

Tubing	Temperature
FEP tubing/TH series	80°C or more
Super PFA tubing/TL series	120°C or more

Spare Parts

Description	Tubing O.D.	Part no.	Material
O-ring	—	M-5-F	FDA compliant FKM
Bulkhead nut	ø3.2, ø4	KQG223-P01	Stainless steel 316
	ø6	KQG206-P01	
	ø8	KQG208-P01	
	ø10	KQG210-P01	
	ø12	KQG212-P01	
	ø16	KQG216-P01	

Cross Reference Table of the Inner Sleeve

Tubing O.D.	Tubing material			Applicable inner sleeve	
	TUS (Soft polyurethane)	TH/THI (FEP)	TL/TIL (Super PFA)	Part no.	Length
ø4	—	TH0402	—	TJG-0402	18
	TUS0425	TH0425	—	TJG-0425	18
	—	—	TL0403	TJG-0403	18
ø6	TUS0604	TH0604	TL0604	TJG-0604	19
	TUS0805	—	—	TJG-0805	20.5
ø8	—	TH0806	TL0806	TJG-0806	20.5
	TUS1065	—	—	TJG-1065	23
ø10	—	TH1075	—	TJG-1075	23
	—	TH1008	TL1008	TJG-1008	23
	TUS1208	—	—	TJG-1208	24
ø12	—	TH1209	—	TJG-1209	24
	—	TH1210	TL1210	TJG-1210	24

* Stainless steel 316 is used for the TJG series.

KQG2-F Series

Applicable Tubing: Metric Size, Connection Thread: M, R, Rc

How to Order

KQG2 H 04 - 02 - F

Body type

Symbol	Model
H	Male connector, Straight union, Different diameter straight
S	Hexagon socket head male connector
L	Male elbow, Union elbow
T	Male branch tee, Union tee, Different diameter tee
E	Bulkhead union, Bulkhead connector
U	Union "Y", Different diameter union "Y"
R	Plug-in reducer
W	Extended male elbow
F	Female connector

* Plugs are excluded as the standard plug is FDA-compliant.

Tubing size (Metric)

Symbol	Size
23	ø3.2
04	ø4
06	ø6
08	ø8
10	ø10
12	ø12
16	ø16

FDA compliant

Thread size, Tubing size

Symbol	Size	
M5	M5 x 0.8	Thread size
01	R1/8, Rc1/8	
02	R1/4, Rc1/4	
03	R3/8, Rc3/8	
04	R1/2, Rc1/2	
00	Same tubing O.D.	Tubing size
04	ø4	
06	ø6	
08	ø8	
10	ø10	
12	ø12	
16	ø16	

* Sealant is unavailable for this product as no FDA-compliant material is available.

Construction

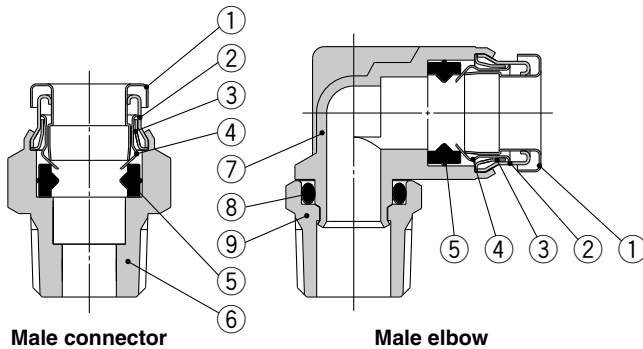

Component Parts

No.	Description	Material
1	Release button	Stainless steel 316
2	Guide 1	Stainless steel 316
3	Guide 2	Stainless steel 316
4	Chuck	Stainless steel 316
5	Seal	FDA compliant FKM (NSF H1 grease)
6	Male connector body	Stainless steel 316
7	Male elbow body	Stainless steel 316 (NSF H1 grease)
8	O-ring	FDA compliant FKM (NSF H1 grease)
9	Stud	Stainless steel 316

Stainless Steel 316 One-touch Fittings **KQG2-F Series**

Applicable Tubing: Metric Size, Connection Thread: M, R, Rc

Dimensions

Male Connector: KQG2H



Applicable tubing O.D. [mm]	Connection thread R, M	Model	H (Width across flats)	øD	ød	L	A*1	M	Effective area [mm ²]*2	Weight [g]
ø3.2	M5 x 0.8	KQG2H23-M5-F	8	—	8	17.8	13.8	12	3	3.6
	1/8	KQG2H23-01-F	10			15.4	12.3		3.4	5.7
	1/4	KQG2H23-02-F	14			21	16.3		16.9	
ø4	M5 x 0.8	KQG2H04-M5-F	10	—	8	18.4	14.4	12.6	4	5.5
	1/8	KQG2H04-01-F	10			15.3	12.2		4.7	4.7
	1/4	KQG2H04-02-F	14			20.9	16.2		15.8	
ø6	M5 x 0.8	KQG2H06-M5-F	12	—	8	19.6	15.6	13.6	4	7.7
	1/8	KQG2H06-01-F	12			18.1	15		7	7
	1/4	KQG2H06-02-F	14			20.8	16.1		13.1	14.5
	3/8	KQG2H06-03-F	17			23	17.9		27.3	
ø8	1/8	KQG2H08-01-F	14	—	—	24.5	21.4	16.1	26.1	12.8
	1/4	KQG2H08-02-F				22.3	17.6			12.9
	3/8	KQG2H08-03-F				23.7	18.6			24.7
ø10	1/8	KQG2H10-01-F	17	—	—	25.5	22.4	17	26.1	18.9
	1/4	KQG2H10-02-F				27.9	23.2			21.6
	3/8	KQG2H10-03-F				23	17.9			20.6
	1/2	KQG2H10-04-F				28.6	22.2			51.1
ø12	1/4	KQG2H12-02-F	19	—	—	30.5	25.8	18.6	58.3	27.4
	3/8	KQG2H12-03-F				24.7	19.6			20.5
	1/2	KQG2H12-04-F				28.7	22.3			44.6
ø16	3/8	KQG2H16-03-F	24	24.6	—	33.6	28.5	20.8	81	46
	1/2	KQG2H16-04-F				29.5	23.1			113

- *1 Reference dimensions after installation for R thread
- *2 Value of FEP tubing
Value of nylon tubing for ø16 only
- *3 In the case of M5, the screw length (L - A) is longer than that of the KQG2 series.

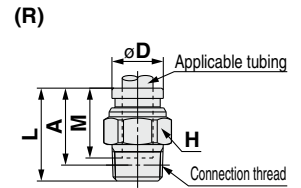
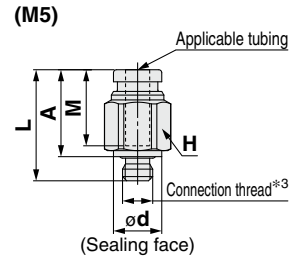

Hexagon Socket Head Male Connector: KQG2S



Applicable tubing O.D. [mm]	Connection thread R, M	Model	H (Width across flats)	øD*1	ød	L	A*2	M	Effective area [mm ²]*3	Weight [g]
ø3.2	M5 x 0.8	KQG2S23-M5-F	2	9	8	17.8	13.8	12	3	4.2
ø4	M5 x 0.8	KQG2S04-M5-F	2	9	8	18.4	14.4	12.6	4	4.1
	1/8	KQG2S04-01-F	3	10	—	19.6	16.5		4.1	7.6
ø6	M5 x 0.8	KQG2S06-M5-F	2	12	8	20.1	16.1	13.6	4	7.4
	1/8	KQG2S06-01-F	4			17.5	10		8.7	
	1/4	KQG2S06-02-F	4			15.9	10.7		14	
ø8	1/8	KQG2S08-01-F	5	14	—	24.7	21.6	16.1	17.2	12.3
	1/4	KQG2S08-02-F	6			22.9	18.2		23.3	12.8
	3/8	KQG2S08-03-F	6			23.1	18		22.8	
ø10	1/8	KQG2S10-01-F	5	17	—	25.6	22.5	17	17.2	17.7
	1/4	KQG2S10-02-F	8			27.5	22.8		19.1	
	3/8	KQG2S10-03-F	8			18.9	20.9			
	1/2	KQG2S10-04-F	22			17.6	37.2			
ø12	1/4	KQG2S12-02-F	8	19	—	30.6	25.9	18.6	46	24.8
	3/8	KQG2S12-03-F	10			19.8	19.3			
	1/2	KQG2S12-04-F	10			24.9	18.5		33.6	
ø16	3/8	KQG2S16-03-F	10	24.6	—	33.2	28.1	20.8	81	41.6
	1/2	KQG2S16-04-F	12			29.4	23		113	38.4

- *1 For the ø16, this dimension refers to the O.D. of the release button.
- *2 Reference dimensions after installation for R thread
- *3 Value of FEP tubing
Value of nylon tubing for ø16 only
- *4 In the case of M5, the screw length (L - A) is longer than that of the KQG2 series.

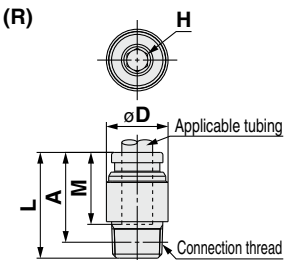
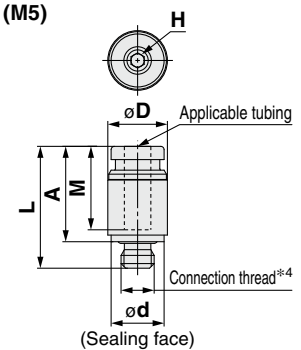

Straight Union: KQG2H



Applicable tubing O.D. [mm]	Model	øD*1	L	M	Effective area [mm ²]*2	Weight [g]
ø3.2	KQG2H23-00-F	9	25	12	3.4	6.5
ø4	KQG2H04-00-F	9	26.2	12.6	5.6	6.5
ø6	KQG2H06-00-F	12	28.2	13.6	13.1	11.5
ø8	KQG2H08-00-F	14	33.2	16.1	26.1	16.6
ø10	KQG2H10-00-F	17	35	17	41.5	26
ø12	KQG2H12-00-F	19	38.2	18.6	58.3	32.2
ø16	KQG2H16-00-F	24.6	42.6	20.8	113	53.7

- *1 For the ø16, this dimension refers to the O.D. of the release button.
- *2 Value of FEP tubing
Value of nylon tubing for ø16 only

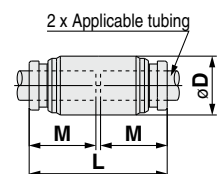

EHEDG Compliant

Metric M, G KFG2H□-E

Clean Design

Metric M, G KFG2H□-C

FDA Compliant

Metric M, R, Rc KQG2-F

Inch UNF, NPT KQG2-F

Metric G KQG2-F

Metric M, R, Rc KQB2-F

Inch UNF, NPT KQB2-F

Metric G KQB2-F

Metric R, Rc KFG2-F

Inch NPT KFG2-F

Metric G KFG2-F

Precautions

KQG2-F Series

Applicable Tubing: Metric Size, Connection Thread: M, R, Rc

Dimensions

Male Elbow: KQG2L

Applicable tubing O.D. (mm)	Connection thread R, M	Model	H (Width across flats)	ϕD^{*1}	ϕd	L1	L2	A ^{*2}	M	Effective area [mm ²] ^{*3}	Weight [g]
$\phi 3.2$	M5 x 0.8	KQG2L23-M5-F	8	8.3	8	13.1	15.9	16.1	12	2.6	6.5
	1/8	KQG2L23-01-F	10			13.6	14.9	15.9		3	7.6
	1/4	KQG2L23-02-F	14			18.7	18.1	16			
$\phi 4$	M5 x 0.8	KQG2L04-M5-F	8	9.1	8	13.7	16.3	16.9	12.6	3.5	7.1
	1/8	KQG2L04-01-F	10			14.4	15.3	16.7		4.2	8.5
	1/4	KQG2L04-02-F	14			19.1	18.9	16.8			
$\phi 6$	M5 x 0.8	KQG2L06-M5-F	8	11.4	8	14.7	17.4	19.1	13.6	3.5	9
	1/8	KQG2L06-01-F	10			15.9	16.4	19		11.4	10.1
	1/4	KQG2L06-02-F	14			20.2	21.2	18.4		18.4	
	3/8	KQG2L06-03-F	17			21.6	22.2	29.9			
$\phi 8$	1/8	KQG2L08-01-F	12	13.7	—	18.6	18.3	22	16.1	21.6	14.6
	1/4	KQG2L08-02-F	14			19.1	21.5	23.6		20.3	
	3/8	KQG2L08-03-F	17			22.9	24.6	31.6			
$\phi 10$	1/8	KQG2L10-01-F	12	16.6	—	20	19.7	24.9	17	21.6	20.2
	1/4	KQG2L10-02-F	14			22.9	26.5	23.3			
	3/8	KQG2L10-03-F	17			24.3	27.5	33.6			
	1/2	KQG2L10-04-F	22			28.5	30.4	60.1			
$\phi 12$	1/4	KQG2L12-02-F	14	18.7	—	22.6	24	28.6	18.6	50.2	27.1
	3/8	KQG2L12-03-F	17			23.6	25.3	29.5		33.7	
	1/2	KQG2L12-04-F	22			29.5	32.4	58.7			
$\phi 16$	3/8	KQG2L16-03-F	19	24.6	—	26.3	28	34.5	20.8	71	46.3
	1/2	KQG2L16-04-F	22			27.3	31.8	37		100	61.3

*1 For the $\phi 16$, this dimension refers to the O.D. of the release button.
*2 Reference dimensions after installation for R thread

*3 Value of FEP tubing
Value of nylon tubing for $\phi 16$ only
*4 In the case of M5, the screw length ($\phi D/2 + L2 - A$) is longer than that of the KQG2 series.

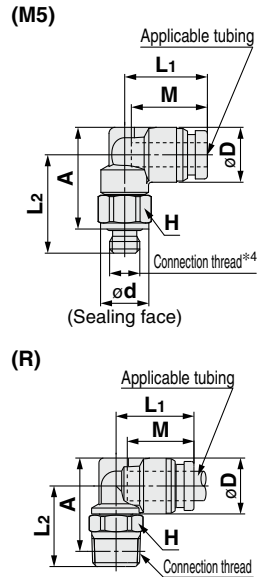

Male Branch Tee: KQG2T

Applicable tubing O.D. (mm)	Connection thread R, M	Model	H (Width across flats)	ϕD^{*1}	ϕd	L1	L2	A ^{*2}	M	Effective area [mm ²] ^{*3}	Weight [g]
$\phi 3.2$	M5 x 0.8	KQG2T23-M5-F	8	8.3	8	13.1	15.9	16.1	12	3.2	8.3
	1/8	KQG2T23-01-F	10			13.6	14.9	15.9		3.4	9.4
	1/4	KQG2T23-02-F	14			18.7	18.1	17.7			
$\phi 4$	M5 x 0.8	KQG2T04-M5-F	8	9.1	8	13.7	16.3	16.9	12.6	4.5	9.2
	1/8	KQG2T04-01-F	10			14.4	15.3	16.7		6	10.4
	1/4	KQG2T04-02-F	14			19.1	18.9	18.8			
$\phi 6$	M5 x 0.8	KQG2T06-M5-F	8	11.4	8	14.7	17.4	19.1	13.6	4.5	12.1
	1/8	KQG2T06-01-F	10			15.9	16.4	19		13.9	13.4
	1/4	KQG2T06-02-F	14			20.2	21.2	21.8		21.8	
	3/8	KQG2T06-03-F	17			21.6	22.2	33			
$\phi 8$	1/8	KQG2T08-01-F	12	13.7	—	18.6	18.3	22	16.1	26.3	20
	1/4	KQG2T08-02-F	14			19.1	21.5	23.6		25.5	
	3/8	KQG2T08-03-F	17			22.9	24.6	36.8			
$\phi 10$	1/8	KQG2T10-01-F	12	16.6	—	20	19.7	24.9	17	40.8	28.4
	1/4	KQG2T10-02-F	14			22.9	26.5	31.1			
	3/8	KQG2T10-03-F	17			24.3	27.5	41.4			
	1/2	KQG2T10-04-F	22			28.5	30.4	68			
$\phi 12$	1/4	KQG2T12-02-F	14	18.7	—	22.6	24	28.6	18.6	57.2	37.8
	3/8	KQG2T12-03-F	17			23.6	25.3	29.5		39.3	
	1/2	KQG2T12-04-F	22			29.5	32.4	68.8			
$\phi 16$	3/8	KQG2T16-03-F	19	24.6	—	26.3	28	34.5	20.8	71	63.7
	1/2	KQG2T16-04-F	22			27.3	31.8	37		100	77.6

*1 For the $\phi 16$, this dimension refers to the O.D. of the release button.
*2 Reference dimensions after installation for R thread

*3 Value of FEP tubing
Value of nylon tubing for $\phi 16$ only
*4 In the case of M5, the screw length ($\phi D/2 + L2 - A$) is longer than that of the KQG2 series.

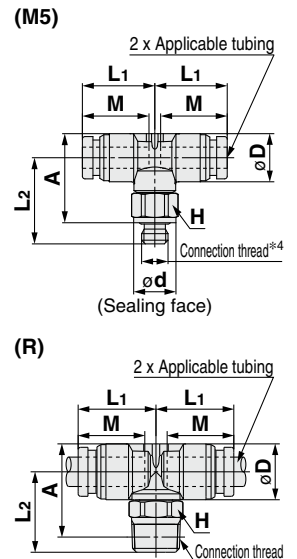

Union Elbow: KQG2L

Applicable tubing O.D. (mm)	Model	ϕD^{*1}	L	A	Q	M	ϕN	ϕO	Effective area [mm ²] ^{*2}	Weight [g]
$\phi 3.2$	KQG2L23-00-F	8.3	13.6	19.3	2.9	12	3.2	5.6	3	6.3
$\phi 4$	KQG2L04-00-F	9.1	14.6	20.5	3.1	12.6	3.2	5.6	4.2	7.4
$\phi 6$	KQG2L06-00-F	11.4	16.6	23	3.6	13.6	3.2	5.6	11.4	11
$\phi 8$	KQG2L08-00-F	13.7	20.1	29.1	5	16.1	4.2	8	21.6	20.2
$\phi 10$	KQG2L10-00-F	16.6	22	31.7	5.7	17	4.2	8	35.2	29.6
$\phi 12$	KQG2L12-00-F	18.7	24.6	35	6.4	18.6	4.2	8	50.2	37.1
$\phi 16$	KQG2L16-00-F	24.6	28.8	40.5	7.7	20.8	4.2	8	100	59.7

*1 For the $\phi 16$, this dimension refers to the O.D. of the release button.

*2 Value of FEP tubing
Value of nylon tubing for $\phi 16$ only

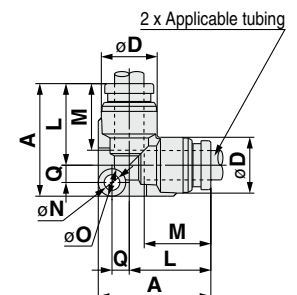

Stainless Steel 316 One-touch Fittings **KQG2-F Series**

Applicable Tubing: Metric Size, Connection Thread: M, R, Rc

Dimensions

Bulkhead Union: KQG2E



Applicable tubing O.D. [mm]	Model	T (M)	H (Width across flats)	L	Mounting hole	M	Effective area [mm ²] ^{*1}	Weight [g]
ø3.2	KQG2E23-00-F	M10 x 1	12	32.2	11	12	3.4	14
ø4	KQG2E04-00-F	M10 x 1	12	32.4	11	12.6	5.6	14
ø6	KQG2E06-00-F	M14 x 1	17	33.6	15	13.6	13.1	25.8
ø8	KQG2E08-00-F	M15 x 1	19	36.4	16	16.1	26.1	30.4
ø10	KQG2E10-00-F	M18 x 1	21	37.2	19	17	41.5	40.3
ø12	KQG2E12-00-F	M20 x 1	24	39.2	21	18.6	58.3	49.9
ø16	KQG2E16-00-F	M27 x 1	30	42.6	28	20.8	113	87.3

*1 Value of FEP tubing
Value of nylon tubing for ø16 only

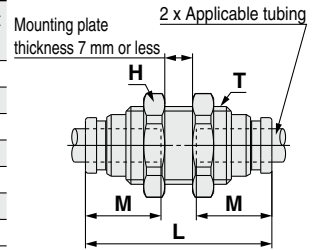

Union Tee: KQG2T



Applicable tubing O.D. [mm]	Model	øD ^{*1}	L	A	Q	M	øN	øO	Effective area [mm ²] ^{*2}	Weight [g]
ø3.2	KQG2T23-00-F	8.3	13.6	20.5	4.1	12	3.2	5.6	3.4	7.9
ø4	KQG2T04-00-F	9.1	14.6	21.8	4.4	12.6	3.2	5.6	6.4	9.5
ø6	KQG2T06-00-F	11.4	16.6	24.6	5.2	13.6	3.2	5.6	13.4	14.2
ø8	KQG2T08-00-F	13.7	20.1	31.1	7	16.1	4.2	8	25.6	24.4
ø10	KQG2T10-00-F	16.6	22	34	8	17	4.2	8	40	36.8
ø12	KQG2T12-00-F	18.7	24.6	37.7	9.1	18.6	4.2	8	57.4	46.9
ø16	KQG2T16-00-F	24.6	28.8	43.4	10.6	20.8	4.2	8	100	75.5

*1 For the ø16, this dimension refers to the O.D. of the release button.
*2 Value of FEP tubing
Value of nylon tubing for ø16 only

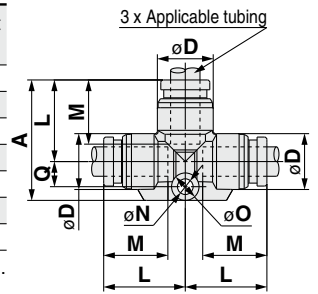

Union "Y": KQG2U



Applicable tubing O.D. [mm]	Model	øD ^{*1}	W	L ₁	L ₂	P	M	øN	øO	Effective area [mm ²] ^{*2}	Weight [g]
ø3.2	KQG2U23-00-F	8.3	16.4	29	11	8.1	12	3.2	5.6	3.4	9.2
ø4	KQG2U04-00-F	9.1	18.2	30.4	11.3	9.1	12.6	3.2	5.6	4.2	11.1
ø6	KQG2U06-00-F	11.4	22.9	34.9	12.2	11.5	13.6	3.2	5.6	13.4	18.8
ø8	KQG2U08-00-F	13.7	28.3	40.1	14.1	14.6	16.1	4.2	8	25.6	29.7
ø10	KQG2U10-00-F	16.6	34.2	44	14.4	17.6	17	4.2	8	40	47.4
ø12	KQG2U12-00-F	18.7	38.5	48.4	15.8	19.8	18.6	4.2	8	57.4	62.1
ø16	KQG2U16-00-F	24.6	49.3	56.6	17.3	26	20.8	4.2	8	113	110.2

*1 For the ø16, this dimension refers to the O.D. of the release button.
*2 Value of FEP tubing
Value of nylon tubing for ø16 only

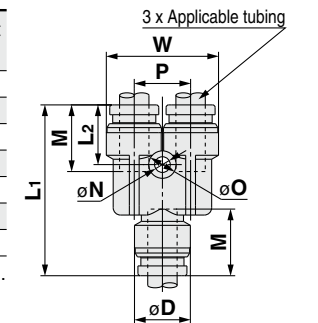

Different Diameter Tee: KQG2T



Applicable tubing O.D. [mm]		Model	øD ^{*1}	øD ₂	L ₁	L ₂	L ₃	Q	M ₁	M ₂	øN	øO	Effective area [mm ²] ^{*2}	Weight [g]
ø3.2	ø4	KQG2T23-04-F	9.1	8.3	14.2	14.1	21.1	4.1	12.6	12	3.2	5.6	3.8	8.5
ø4	ø6	KQG2T04-06-F	11.4	9.1	15.6	15.7	22.8	4.4	13.6	12.6	3.2	5.6	7.1	11.5
ø6	ø8	KQG2T06-08-F	13.7	11.4	19.1	17.7	29.5	6.4	16.1	13.6	4.2	8	16.4	20
ø8	ø10	KQG2T08-10-F	16.6	13.7	21	21.2	32.1	7.1	17	16.1	4.2	8	36	29.8
ø10	ø12	KQG2T10-12-F	18.7	16.6	23.6	23.1	35.7	8.1	18.6	17	4.2	8	56	41.3
ø12	ø16	KQG2T12-16-F	24.6	18.7	26.8	26.7	39.9	9.1	20.8	18.6	4.2	8	108.5	58

*1 For the ø16, this dimension refers to the O.D. of the release button.
*2 Value of FEP tubing

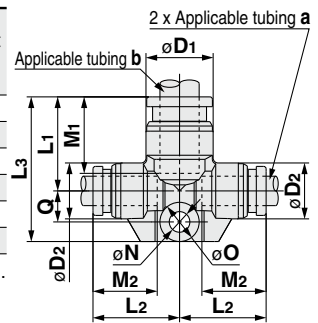

Plug-in Reducer: KQG2R



Applicable tubing O.D. [mm]	Applicable fitting size ød	Model	øD	L	A	M	Effective area [mm ²] ^{*1}	Weight [g]
ø3.2	ø4	KQG2R23-04-F	9	32.9	20.3	12	3.4	4.7
ø4	ø6	KQG2R04-06-F	9	34.4	20.8	12.6	5.6	6.7
ø6	ø8	KQG2R06-08-F	12	38.4	22.3	13.6	13.1	12.1
ø8	ø10	KQG2R08-10-F	14	41.9	24.9	16.1	26.1	18.3
ø10	ø12	KQG2R10-12-F	17	44.8	26.2	17	41.5	26.5
ø12	ø16	KQG2R12-16-F	19	42.9	22.1	18.6	58.3	35.4

*1 Value of FEP tubing

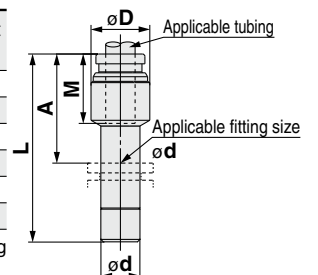

EHEDG Compliant

Metric M, G KFG2H□-E

Clean Design

Metric M, G KFG2H□-C

FDA Compliant

Metric M, R, Rc KQG2-F

Inch UNF, NPT KQG2-F

Metric G KQG2-F

Metric M, R, Rc KQB2-F

Inch UNF, NPT KQB2-F

Metric G KQB2-F

Metric R, Rc KFG2-F

Inch NPT KFG2-F

Metric G KFG2-F

Precautions

KQG2-F Series

Applicable Tubing: Metric Size, Connection Thread: M, R, Rc

Dimensions

Different Diameter Straight: KQG2H



Applicable tubing O.D. [mm]		Model	øD*1	L	M1	M2	Effective area [mm ²] ^{*2}	Weight [g]
a	b							
ø3.2	ø4	KQG2H23-04-F	9	25.6	12	12.6	3.4	6.5
ø4	ø6	KQG2H04-06-F	12	27.2	12.6	13.6	5.6	11.6
ø6	ø8	KQG2H06-08-F	14	30.7	13.6	16.1	13.1	16.3
ø8	ø10	KQG2H08-10-F	17	34.1	16.1	17	26.1	26
ø10	ø12	KQG2H10-12-F	19	36.6	17	18.6	41.5	33.3
ø12	ø16	KQG2H12-16-F	24.6	40.4	18.6	20.8	58.3	54.7

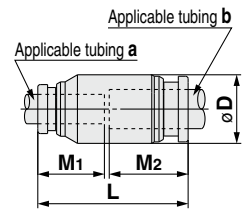

*1 For the ø16, this dimension refers to the O.D. of the release button.
*2 Value of FEP tubing

Different Diameter Union "Y": KQG2U



Applicable tubing O.D. [mm]		Model	øD*1	L1	L2	P	W	M1	M2	øN	øO	Effective area [mm ²] ^{*2}	Weight [g]
a	b												
ø3.2	ø4	KQG2U23-04-F	9.1	27	10.8	8.1	16.4	12	12.6	3.2	5.6	3.2	8.5
ø4	ø6	KQG2U04-06-F	11.4	29.3	11.2	9.1	18.2	12.6	13.6	3.2	5.6	4.2	11.9
ø6	ø8	KQG2U06-08-F	13.7	33.7	12.2	11.5	22.9	13.6	16.1	4.2	8	13.4	19.3
ø8	ø10	KQG2U08-10-F	16.6	38.3	13.8	14.6	28.3	16.1	17	4.2	8	25.6	31.6
ø10	ø12	KQG2U10-12-F	18.7	43	14	17.6	34.2	17	18.6	4.2	8	40	47.6
ø12	ø16	KQG2U12-16-F	24.6	47.4	15.6	19.8	38.5	18.6	20.8	4.2	8	57.4	67.6

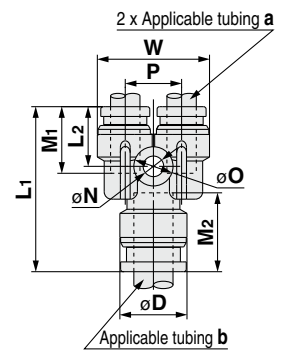

*1 For the ø16, this dimension refers to the O.D. of the release button.
*2 Value of FEP tubing

Bulkhead Connector: KQG2E



Applicable tubing O.D. [mm]	Connection thread Rc	Model	T (M)	Width across flats		L1	L2	Mounting hole	M	Effective area [mm ²] ^{*1}	Weight [g]		
				H1	H2								
ø3.2	1/4	KQG2E23-02-F	M10 x 1	17	12	31	14.8	11	12	3.4	26.1		
ø4	1/8	KQG2E04-01-F	M10 x 1	14	12	25.8	9.7	11	12.6	5.6	16		
	1/4	KQG2E04-02-F		17	12	30.9	14.8				25.6		
ø6	1/8	KQG2E06-01-F	M14 x 1	17	17	24.2	7	15	13.6	13.1	24.4		
	1/4	KQG2E06-02-F				30.9	13.7				30.9		
	3/8	KQG2E06-03-F				19	14.9				32.1	14.9	32
ø8	1/8	KQG2E08-01-F	M15 x 1	17	19	26.3	8.1	16	16.1	26.1	28		
	1/4	KQG2E08-02-F				31.3	13.1				31.3	13.1	31.2
	3/8	KQG2E08-03-F				19	14.6				32.8	14.6	32.7
ø10	1/4	KQG2E10-02-F	M18 x 1	19	21	31.6	13	19	17	41.5	42.8		
	3/8	KQG2E10-03-F				33	14.4				33	14.4	37.5
	3/8	KQG2E12-03-F				M20 x 1	21				24	34	14.4
1/2	KQG2E12-04-F	24	24	39.3	19.7		21	18.6	58.3	60.7			
ø16	3/8	KQG2E16-03-F	M27 x 1	29	30	35.3	13.3	28	20.8	96	107.8		
	1/2	KQG2E16-04-F				40.6	18.6				113	114.6	

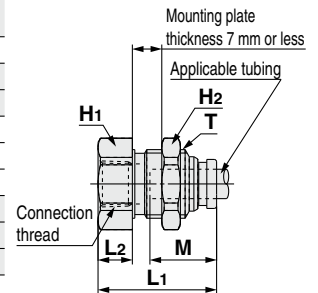

*1 Value of FEP tubing
Value of nylon tubing for ø16 only

Stainless Steel 316 One-touch Fittings **KQG2-F Series**

Applicable Tubing: Metric Size, Connection Thread: M, R, Rc

Dimensions

Extended Male Elbow: KQG2W



Applicable tubing O.D. [mm]	Connection thread R, M	Model	H (Width across flats)	øD*1	ød	L1	L2	A*2	M	Effective area [mm ²]*3	Weight [g]
ø3.2	M5 x 0.8	KQG2W23-M5-F	8	8.3	8	13.1	32.3	32.5	12	2.8	13.2
	1/8	KQG2W23-01-F	10		—	13.6	31.3	32.3			14.7
	1/4	KQG2W23-02-F	14		—	—	35.1	34.5			33.1
ø4	M5 x 0.8	KQG2W04-M5-F	8	9.1	8	13.7	32.7	33.3	12.6	3	13.8
	1/8	KQG2W04-01-F	10		—	14.4	31.7	33.1			15.6
	1/4	KQG2W04-02-F	14		—	—	35.5	35.3			33.9
ø6	M5 x 0.8	KQG2W06-M5-F	8	11.4	8	14.7	33.8	35.5	13.6	3	15.7
	1/8	KQG2W06-01-F	10		—	—	32.8	35.4			17.2
	1/4	KQG2W06-02-F	14		—	15.9	36.6	37.6			35.5
	3/8	KQG2W06-03-F	17		—	—	38	38.6			57.4
ø8	1/8	KQG2W08-01-F	12	13.7	—	18.6	37	40.7	16.1	20.5	28
	1/4	KQG2W08-02-F	14		—	19.1	40.2	42.3			37.7
	3/8	KQG2W08-03-F	17		—	—	41.6	43.3			60.9
ø10	1/4	KQG2W10-02-F	14	16.6	—	21	46.6	50.2	17	33.5	40.7
	3/8	KQG2W10-03-F	17		—	—	45.9	49.1			61.9
	1/2	KQG2W10-04-F	22		—	—	50.1	52			117.3
ø12	1/4	KQG2W12-02-F	14	18.7	—	22.6	47.7	52.3	18.6	47.7	44.6
	3/8	KQG2W12-03-F	17		—	23.6	49	53.2			56.3
	1/2	KQG2W12-04-F	22		—	—	53.2	56.1			112.9
ø16	3/8	KQG2W16-03-F	19	24.6	—	26.3	57.6	64.1	20.8	71	86.6
	1/2	KQG2W16-04-F	22		—	27.3	61.4	66.6			100

*1 For the ø16, this dimension refers to the O.D. of the release button.

*2 Reference dimensions after installation for R thread

*3 Value of FEP tubing
Value of nylon tubing for ø16 only

*4 In the case of M5, the screw length ($\phi D/2 + L2 - A$) is longer than that of the KQG2 series.

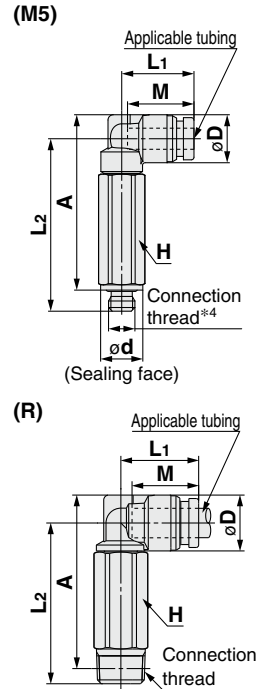

Female Connector: KQG2F



Applicable tubing O.D. [mm]	Connection thread Rc	Model	H (Width across flats)	øD*1	L1	L2	M	Effective area [mm ²]*2	Weight [g]
ø3.2	1/8	KQG2F23-01-F	12	8	23.3	9.8	12	3.4	8.9
ø4	1/8	KQG2F04-01-F	12	8.7	23.7	9.8	12.6	5.6	9.2
	1/4	KQG2F04-02-F	17		28.7	13.2			21.6
ø6	1/8	KQG2F06-01-F	12	11.1	24.2	10	13.6	13.1	10.5
	1/4	KQG2F06-02-F	17		29.2	13.4			23.1
	3/8	KQG2F06-03-F	19		30.6	14.2			24.5
ø8	1/8	KQG2F08-01-F	14	13.4	26.3	9.6	16.1	26.1	16.3
	1/4	KQG2F08-02-F	17		31.3	13.7			25.5
	3/8	KQG2F08-03-F	19		32.7	14.4			27
ø10	1/4	KQG2F10-02-F	17	16.4	31.6	13.9	17	41.5	28.8
	3/8	KQG2F10-03-F	19		33	14.7			30.4
ø12	1/4	KQG2F12-02-F	19	18.5	32.6	13.3	18.6	58.3	37.5
	3/8	KQG2F12-03-F	19		34	14.7			32.3
	1/2	KQG2F12-04-F	24		39.3	18.4			50.2
ø16	3/8	KQG2F16-03-F	24	24.6	35.3	13.5	20.8	81	59.7
	1/2	KQG2F16-04-F	24		40.6	18.8			113

*1 For the ø10, ø12, and ø16, this dimension refers to the O.D. of the release button.

*2 Value of FEP tubing
Value of nylon tubing for ø16 only

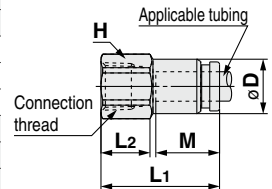

Plug: KQG2P



Applicable fitting size ød	Model	øD	L	A	Weight [g]
ø3.2	KQG2P-23	5	28.9	16.9	2.7
ø4	KQG2P-04	6	29.6	17	4.1
ø6	KQG2P-06	8	30.8	17.2	8.5
ø8	KQG2P-08	10	33.7	17.6	15.5
ø10	KQG2P-10	12	34.6	17.6	24.1
ø12	KQG2P-12	14	36.5	17.9	35.8
ø16	KQG2P-16	18	38.6	17.8	65.5

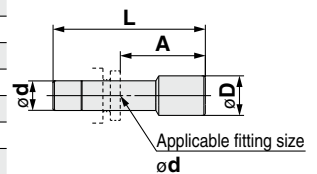

EHEDG Compliant

Metric M, G KFG2H□-E

Clean Design

Metric M, G KFG2H□-C

FDA Compliant

Metric M, R, Rc KQG2-F

Inch UNF, NPT KQG2-F

Metric G KQG2-F

Metric M, R, Rc KQB2-F

Inch UNF, NPT KQB2-F

Metric G KQB2-F

Metric R, Rc KFG2-F

Inch NPT KFG2-F

Metric G KFG2-F

Precautions

Stainless Steel 316 One-touch Fittings

Applicable Tubing: Inch Size, Connection Thread: UNF, NPT

KQG2-F Series

RoHS



Applicable Tubing

Tubing material*1	FEP, PFA, Nylon, Soft nylon, Polyurethane, Polyolefin
Tubing O.D.	ø1/8", ø5/32", ø1/4", ø5/16", ø3/8", ø1/2"

*1 Considering the product application, FDA-compliant products are recommended.

Specifications

Fluid	Air, Water*1, Steam*2
Operating pressure range*3	-100 kPa to 1 MPa*4
Proof pressure	3.0 MPa
Ambient and fluid temperatures*5	-5 to 150°C (No freezing)*4
Lubricant	NSF H1 grease
Seal on the threads	Without sealant

*1 Deionized water is not recommended for use as it may affect the material used in the fittings. In addition, it is known to degrade the water quality.

*2 Please contact SMC for applicable tubing separately.

*3 Do not use the fittings with a leak tester or for vacuum retention because they are not guaranteed for zero leakage.

*4 Check the operating pressure range and operating temperature range of the tubing.

*5 It is recommended that you use the inner sleeve in the following conditions. (Except ø1/8")

- When using in an environment where the fluid temperature changes drastically
- When using at a high temperature

* Temperature Condition of Mounting the Inner Sleeve

Tubing	Temperature
FEP tubing/TH series	80°C or more
Super PFA tubing/TL series	120°C or more

Spare Parts

Description	Tubing O.D.	Part no.	Material
O-ring	—	M-5-F	FDA compliant FKM
Bulkhead nut	ø1/8", ø5/32"	KQG201-P01	Stainless steel 316
	ø1/4"	KQG207-P01	
	ø5/16"	KQG209-P01	
	ø3/8"	KQG211-P01	
	ø1/2"	KQG213-P01	

Cross Reference Table of the Inner Sleeve

Tubing O.D.	Tubing material		Applicable inner sleeve	
	TH/THI (FEP)	TL/TIL (Super PFA)	Part no.	Length
ø5/32"	TH0402	—	TJG-0402	18
	TH0425	—	TJG-0425	18
	—	TL0403	TJG-0403	18
ø1/4"	TIHB07	TIL07	TJG-0604	19
	TIHA07	—	TJG-0746	19
ø5/16"	TH0806	TL0806	TJG-0806	20.5
ø3/8"	TIHB11	TIL11	TJG-1065	23
	TIHA11	—	TJG-1107	23
ø1/2"	TIH13	TIL13	TJG-1395	24

* Stainless steel 316 is used for the TJG series.

How to Order

KQG2 H 03 - N 02 - F

Body type

Symbol	Model
H	Male connector, Straight union, Different diameter straight
S	Hexagon socket head male connector
L	Male elbow, Union elbow
T	Male branch tee, Union tee, Different diameter tee
E	Bulkhead union, Bulkhead connector
U	Union "Y", Different diameter union "Y"
R	Plug-in reducer
W	Extended male elbow
F	Female connector

* Plugs are excluded as the standard plug is FDA-compliant.

Tubing size (Inch)

Symbol	Size
01	ø 1/8"
03	ø 5/32"
07	ø 1/4"
09	ø 5/16"
11	ø 3/8"
13	ø 1/2"

FDA compliant

Thread size, Tubing size

Symbol	Size	
32	10-32UNF	Thread size
01	NPT1/8	
02	NPT1/4	
03	NPT3/8	
04	NPT1/2	Tubing size
00	Same tubing O.D.	
03	ø 5/32"	
07	ø 1/4"	
09	ø 5/16"	
11	ø 3/8"	
13	ø 1/2"	

* Sealant is unavailable for this product as no FDA-compliant material is available.

Thread type

Symbol	Type
N	NPT

Construction

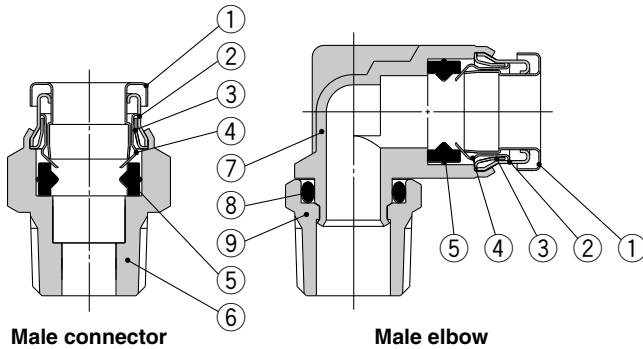

Component Parts

No.	Description	Material
1	Release button	Stainless steel 316
2	Guide 1	Stainless steel 316
3	Guide 2	Stainless steel 316
4	Chuck	Stainless steel 316
5	Seal	FDA compliant FKM (NSF H1 grease)
6	Male connector body	Stainless steel 316
7	Male elbow body	Stainless steel 316 (NSF H1 grease)
8	O-ring	FDA compliant FKM (NSF H1 grease)
9	Stud	Stainless steel 316

EHEDG Compliant

Metric M, G KFG2H-E

Clean Design

Metric M, G KFG2H-C

FDA Compliant

Metric M, R, Rc KQG2-F

Inch UNF, NPT KQG2-F

Metric G KQG2-F

Metric M, R, Rc KQB2-F

Inch UNF, NPT KQB2-F

Metric G KQB2-F

Metric R, Rc KFG2-F

Inch NPT KFG2-F

Metric G KFG2-F

Precautions

KQG2-F Series

Applicable Tubing: Inch Size, Connection Thread: UNF, NPT

Dimensions

Male Connector: KQG2H



Applicable tubing O.D. [inch]	Connection thread UNF, NPT	Model	H (Width across flats)	ød	L	A*1	M	Effective area [mm ²]*2	Weight [g]
ø1/8"	10-32UNF	KQG2H01-32-F	8	8	17.8	13.8	12	3	3.6
	1/8	KQG2H01-N01-F	12	—	17.1	13.9		3.4	8.1
	1/4	KQG2H01-N02-F	14	—	20.9	16.5		16.9	
ø5/32"	10-32UNF	KQG2H03-32-F	10	8	18.4	14.4	12.6	4	5.5
	1/8	KQG2H03-N01-F	12	—	17	13.8		5.6	7.6
	1/4	KQG2H03-N02-F	14	—	20.9	16.5		16.4	
ø1/4"	10-32UNF	KQG2H07-32-F	12	8	21	17	13.5	4	7.5
	1/8	KQG2H07-N01-F	—	20	16.8	13.1		8.6	
	1/4	KQG2H07-N02-F	14	—	20.6			16.2	14.2
	3/8	KQG2H07-N03-F	19	—	23.8			19.1	31.4
ø5/16"	1/8	KQG2H09-N01-F	14	—	24.2		21	16.1	26.1
	1/4	KQG2H09-N02-F	—	23.1	18.7	13.9			
	3/8	KQG2H09-N03-F	19	—	24.6	19.9	28.9		
ø3/8"	1/8	KQG2H11-N01-F	17	—	25	21.8	16.6	26.1	19.4
	1/4	KQG2H11-N02-F	—	26.3	21.9	20.3			
	3/8	KQG2H11-N03-F	19	—	23.6	18.9		41.5	25.2
ø1/2"	1/4	KQG2H13-N02-F	22	—	30.5	26.1	18.5	58.3	36.7
	3/8	KQG2H13-N03-F	—	28.4	23.7	34.4			
	1/2	KQG2H13-N04-F	—	—	22	43.4			

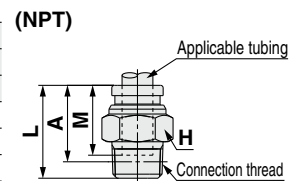
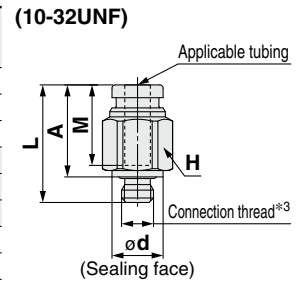

*1 Reference dimensions after installation for NPT thread
 *2 Value of FEP tubing
 *3 In the case of 10-32UNF, the screw length (L - A) is longer than that of the KQG2 series.

Hexagon Socket Head Male Connector: KQG2S



Applicable tubing O.D. [inch]	Connection thread UNF, NPT	Model	H (Width across flats)	øD	ød	L	A*1	M	Effective area [mm ²]*2	Weight [g]	
ø1/8"	10-32UNF	KQG2S01-32-F	2	9	8	17.8	13.8	12	3	4.2	
ø5/32"	10-32UNF	KQG2S03-32-F	2	9	8	18.4	14.4	12.6	4	4.1	
	1/8	KQG2S03-N01-F	2.78	11	—	19.6	16.4		4.1	8.5	
ø1/4"	10-32UNF	KQG2S07-32-F	2	12	8	20	16	13.5	4	7.2	
	1/8	KQG2S07-N01-F	—		17.3	10	8.1				
	1/4	KQG2S07-N02-F	4.76		14	—	20.5		16.1	10.7	13.4
	3/8	KQG2S07-N03-F	—		18	—	15.8		17.2	22.6	
ø5/16"	1/8	KQG2S09-N01-F	5.56	14	—	24.7	21.5	16.1	17.2	12	
	1/4	KQG2S09-N02-F	—		23.1	18.7	23.3		12.8		
	3/8	KQG2S09-N03-F	6.35		18	—	18.4		23.5		
ø3/8"	1/8	KQG2S11-N01-F	5.56	17	—	25.2	22	16.6	17.2	17.8	
	1/4	KQG2S11-N02-F	—		27.1	22.7	21.2				
	3/8	KQG2S11-N03-F	6.35		18	—	18.9		39	23.8	
ø1/2"	1/2	KQG2S11-N04-F	—	22	—	23.6	17.2	38.6			
	1/4	KQG2S13-N02-F	8	20	—	30.5	26.1	18.5	46	26.6	
	3/8	KQG2S13-N03-F	—		29.4	24.7	29				
1/2	KQG2S13-N04-F	9.53	22		—	25.5	19.1		60	34.8	

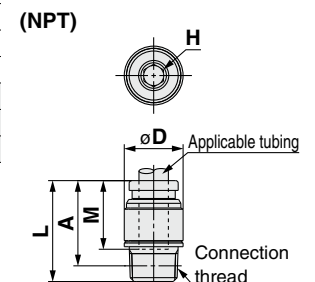
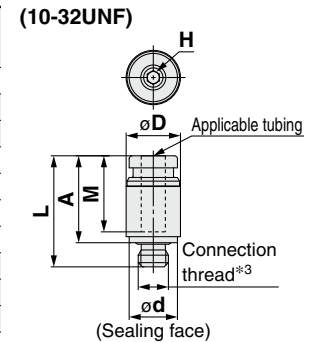

*1 Reference dimensions after installation for NPT thread
 *2 Value of FEP tubing
 *3 In the case of 10-32UNF, the screw length (L - A) is longer than that of the KQG2 series.

Straight Union: KQG2H



Applicable tubing O.D. [inch]	Model	øD	L	M	Effective area [mm ²]*1	Weight [g]
ø1/8"	KQG2H01-00-F	9	25	12	3.4	6.5
ø5/32"	KQG2H03-00-F	9	26.2	12.6	5.6	6.5
ø1/4"	KQG2H07-00-F	12	28	13.5	13.1	11
ø5/16"	KQG2H09-00-F	14	33.2	16.1	26.1	16.6
ø3/8"	KQG2H11-00-F	16	34.2	16.6	41.5	22.7
ø1/2"	KQG2H13-00-F	20	38	18.5	58.3	35.5

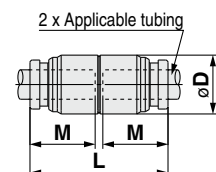

*1 Value of FEP tubing

Stainless Steel 316 One-touch Fittings **KQG2-F Series**

Applicable Tubing: Inch Size, Connection Thread: UNF, NPT

Dimensions

Male Elbow: KQG2L

Applicable tubing O.D. [inch]	Connection thread UNF, NPT	Model	H (Width across flats)	øD	ød	L1	L2	A*1	M	Effective area [mm ²]*2	Weight [g]
ø1/8"	10-32UNF	KQG2L01-32-F	8	8.3	8	13.1	15.9	16.1	12	2.6	6.5
	1/8	KQG2L01-N01-F	12			13.6	14.9	15.8		3	9
	1/4	KQG2L01-N02-F	14			18.7	18.4	16.7			
ø5/32"	10-32UNF	KQG2L03-32-F	8	9.1	8	13.7	16.3	16.9	12.6	3.5	7.1
	1/8	KQG2L03-N01-F	12			14.4	15.3	16.6		4.2	9.9
	1/4	KQG2L03-N02-F	14			19.1	19.2	17.6			
ø1/4"	10-32UNF	KQG2L07-32-F	8	11.7	8	14.7	17.6	19.5	13.5	3.5	9.1
	1/8	KQG2L07-N01-F	12			15.9	16.6	19.2		11.4	11.7
	1/4	KQG2L07-N02-F	14			20.4	21.8	19.4		34.2	
	3/8	KQG2L07-N03-F	19			22.2	23.3	35.7			
ø5/16"	1/8	KQG2L09-N01-F	12	13.7	—	18.6	18.3	21.9	16.1	21.6	15.1
	1/4	KQG2L09-N02-F	14			19.1	21.5	23.9		21.1	
	3/8	KQG2L09-N03-F	19			23.3	25.4	35.7			
ø3/8"	1/8	KQG2L11-N01-F	12	16	—	20	19.4	24.2	16.6	21.6	19.7
	1/4	KQG2L11-N02-F	14			21	22.6	26.2		23.2	
	3/8	KQG2L11-N03-F	19			24.4	27.7	36.7			
	1/2	KQG2L11-N04-F	22			28.2	29.8	60.2			
ø1/2"	1/4	KQG2L13-N02-F	14	19.6	—	22.7	24.4	29.8	18.5	50.2	29.4
	3/8	KQG2L13-N03-F	19			23.7	26.1	31.2		39.2	
	1/2	KQG2L13-N04-F	22			29.9	33.3	61.3			

*1 Reference dimensions after installation for NPT thread
 *2 Value of FEP tubing
 *3 In the case of 10-32UNF, the screw length ($\phi D/2 + L2 - A$) is longer than that of the KQG2 series.

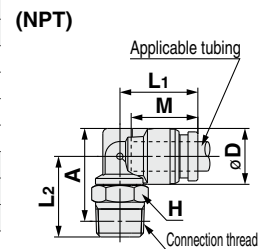
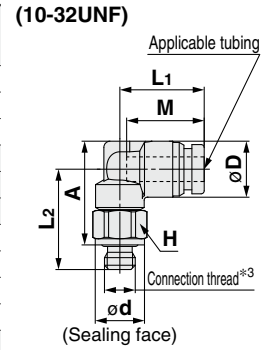

Male Branch Tee: KQG2T

Applicable tubing O.D. [inch]	Connection thread UNF, NPT	Model	H (Width across flats)	øD	ød	L1	L2	A*1	M	Effective area [mm ²]*2	Weight [g]
ø1/8"	10-32UNF	KQG2T01-32-F	8	8.3	8	13.1	15.9	16.1	12	3.2	8.3
	1/8	KQG2T01-N01-F	12			13.6	14.9	15.8		3.4	10.8
	1/4	KQG2T01-N02-F	14			18.7	18.4	18.5			
ø5/32"	10-32UNF	KQG2T03-32-F	8	9.1	8	13.7	16.3	16.9	12.6	4.5	9.2
	1/8	KQG2T03-N01-F	12			14.4	15.3	16.6		6	11.8
	1/4	KQG2T03-N02-F	14			19.1	19.2	19.5			
ø1/4"	10-32UNF	KQG2T07-32-F	8	11.7	8	14.7	17.6	19.5	13.5	4.5	12.3
	1/8	KQG2T07-N01-F	12			15.9	16.6	19.2		13.9	15.1
	1/4	KQG2T07-N02-F	14			20.4	21.8	22.8		37.7	
	3/8	KQG2T07-N03-F	19			22.2	23.3	41			
ø5/16"	1/8	KQG2T09-N01-F	12	13.7	—	18.6	18.3	21.9	16.1	26.3	20.4
	1/4	KQG2T09-N02-F	14			19.1	21.5	23.9		26.3	
	3/8	KQG2T09-N03-F	19			23.3	25.4	41			
ø3/8"	1/8	KQG2T11-N01-F	12	16	—	20	19.4	24.2	16.6	40.8	27.3
	1/4	KQG2T11-N02-F	14			21	22.6	26.2		30.5	
	3/8	KQG2T11-N03-F	19			24.4	27.7	44			
	1/2	KQG2T11-N04-F	22			28.2	29.8	67.4			
ø1/2"	1/4	KQG2T13-N02-F	14	19.6	—	22.7	24.4	29.8	18.5	57.2	41.1
	3/8	KQG2T13-N03-F	19			23.7	26.1	31.2		50.2	
	1/2	KQG2T13-N04-F	22			29.9	33.3	72.3			

*1 Reference dimensions after installation for NPT thread
 *2 Value of FEP tubing
 *3 In the case of 10-32UNF, the screw length ($\phi D/2 + L2 - A$) is longer than that of the KQG2 series.

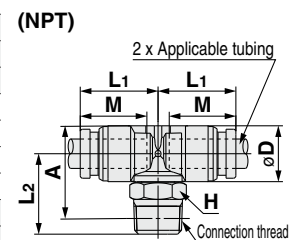
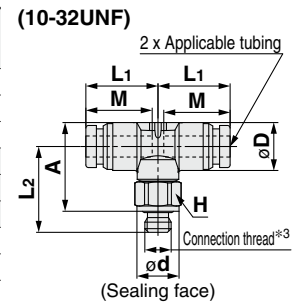

Union Elbow: KQG2L

Applicable tubing O.D. [inch]	Model	øD	L	A	Q	M	øN	øO	Effective area [mm ²]*1	Weight [g]
ø1/8"	KQG2L01-00-F	8.3	13.6	19.3	2.9	12	3.2	5.6	3	6.3
ø5/32"	KQG2L03-00-F	9.1	14.6	20.5	3.1	12.6	3.2	5.6	4.2	7.4
ø1/4"	KQG2L07-00-F	11.7	16.7	23.2	3.7	13.5	3.2	5.6	11.4	11.5
ø5/16"	KQG2L09-00-F	13.7	20.1	29.1	5	16.1	4.2	8	21.6	20.2
ø3/8"	KQG2L11-00-F	16	21.4	31.1	5.7	16.6	4.2	8	35.2	28.2
ø1/2"	KQG2L13-00-F	19.6	24.9	35.3	6.4	18.5	4.2	8	50.2	41.7

*1 Value of FEP tubing

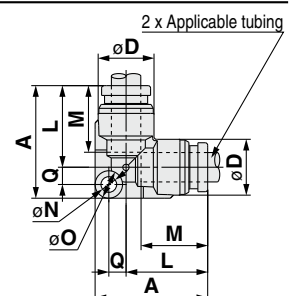

EHEDG Compliant

Metric M, G KFG2H□-E

Clean Design

Metric M, G KFG2H□-C

FDA Compliant

Metric M, R, Rc KQG2-F

Inch UNF, NPT KQG2-F

Metric G KQG2-F

Metric M, R, Rc KQB2-F

Inch UNF, NPT KQB2-F

Metric G KQB2-F

Metric R, Rc KFG2-F

Inch NPT KFG2-F

Metric G KFG2-F

Precautions

KQG2-F Series

Applicable Tubing: Inch Size, Connection Thread: UNF, NPT

Dimensions

Bulkhead Union: KQG2E



Applicable tubing O.D. [inch]	Model	T (UNF)	H (Width across flats)	L	Mounting hole	M	Effective area [mm ²] ^{*1}	Weight [g]
ø1/8"	KQG2E01-00-F	7/16-20UNF	14	34.2	12.5	12	3.4	20.7
ø5/32"	KQG2E03-00-F	7/16-20UNF	14	34.4	12.5	12.6	5.6	20.5
ø1/4"	KQG2E07-00-F	1/2-20UNF	17	35.4	14	13.5	13.1	28
ø5/16"	KQG2E09-00-F	5/8-18UNF	19	39.6	17	16.1	26.1	39.5
ø3/8"	KQG2E11-00-F	3/4-16UNF	22	40.4	20.5	16.6	41.5	57.3
ø1/2"	KQG2E13-00-F	7/8-14UNF	26	44.4	23.5	18.5	58.3	83.2

*1 Value of FEP tubing

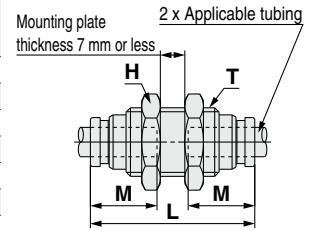

Union Tee: KQG2T



Applicable tubing O.D. [inch]	Model	øD	L	A	Q	M	øN	øO	Effective area [mm ²] ^{*1}	Weight [g]
ø1/8"	KQG2T01-00-F	8.3	13.6	20.5	4.1	12	3.2	5.6	3.4	7.9
ø5/32"	KQG2T03-00-F	9.1	14.6	21.8	4.4	12.6	3.2	5.6	6.4	9.5
ø1/4"	KQG2T07-00-F	11.7	16.7	24.7	5.2	13.5	3.2	5.6	13.4	14.7
ø5/16"	KQG2T09-00-F	13.7	20.1	31.1	7	16.1	4.2	8	25.6	24.4
ø3/8"	KQG2T11-00-F	16	21.4	33.4	8	16.6	4.2	8	40	34.7
ø1/2"	KQG2T13-00-F	19.6	24.9	37.9	9	18.5	4.2	8	57.4	52.3

*1 Value of FEP tubing

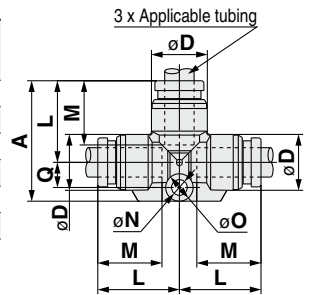

Union "Y": KQG2U



Applicable tubing O.D. [inch]	Model	øD	W	L1	L2	P	M	øN	øO	Effective area [mm ²] ^{*1}	Weight [g]
ø1/8"	KQG2U01-00-F	8.3	16.4	29	11	8.1	12	3.2	5.6	3.4	9.2
ø5/32"	KQG2U03-00-F	9.1	18.2	30.4	11.3	9.1	12.6	3.2	5.6	4.2	11.1
ø1/4"	KQG2U07-00-F	11.7	23.9	34.5	12.1	12.2	13.5	3.2	5.6	13.4	19.6
ø5/16"	KQG2U09-00-F	13.7	28.3	40.1	14.1	14.6	16.1	4.2	8	25.6	29.7
ø3/8"	KQG2U11-00-F	16	33.2	42.2	14	17.2	16.6	4.2	8	40	43.1
ø1/2"	KQG2U13-00-F	19.6	40.2	47.3	15.8	20.6	18.5	4.2	8	57.4	66.4

*1 Value of FEP tubing

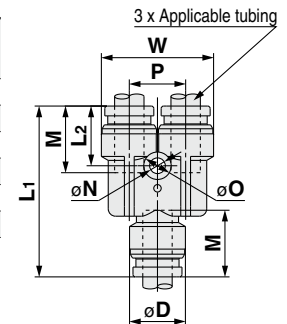

Different Diameter Tee: KQG2T



Applicable tubing O.D. [inch]	Model	øD1	øD2	L1	L2	L3	Q	M1	M2	øN	øO	Effective area [mm ²] ^{*1}	Weight [g]
ø1/8" ø5/32"	KQG2T01-03-F	9.1	8.3	14.2	14.1	21.1	4.1	12.6	12	3.2	5.6	3.8	8.5
ø5/32" ø1/4"	KQG2T03-07-F	11.7	9.1	15.5	15.9	22.7	4.4	13.5	12.6	3.2	5.6	7.1	11.7
ø1/4" ø5/16"	KQG2T07-09-F	13.7	11.7	19.3	17.6	29.6	6.3	16.1	13.5	4.2	8	16.4	20.2
ø5/16" ø3/8"	KQG2T09-11-F	16	13.7	20.6	21	31.7	7.1	16.6	16.1	4.2	8	36	28.9
ø3/8" ø1/2"	KQG2T11-13-F	19.6	16	23.3	23	35.4	8.1	18.5	16.6	4.2	8	56	41.8

*1 Value of FEP tubing

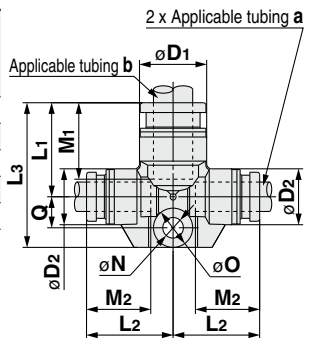

Plug-in Reducer: KQG2R



Applicable tubing O.D. [inch]	Applicable fitting size ød	Model	øD	L	A	M	Effective area [mm ²] ^{*1}	Weight [g]
ø1/8"	ø5/32"	KQG2R01-03-F	9	32.9	20.3	12	3.4	4.7
ø5/32"	ø1/4"	KQG2R03-07-F	9	33.7	20.2	12.6	5.6	7.1
ø1/4"	ø5/16"	KQG2R07-09-F	12	38.4	22.3	13.5	13.1	11.9
ø5/16"	ø3/8"	KQG2R09-11-F	14	41.6	25	16.1	26.1	16.8
ø3/8"	ø1/2"	KQG2R11-13-F	17	39.8	21.3	16.6	41.5	23.5

*1 Value of FEP tubing

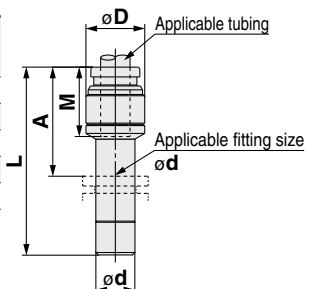

Stainless Steel 316 One-touch Fittings **KQG2-F Series**

Applicable Tubing: Inch Size, Connection Thread: UNF, NPT

Dimensions

Different Diameter Straight: KQG2H



Applicable tubing O.D. [inch]		Model	øD	L	M1	M2	Effective area [mm ²] ^{*1}	Weight [g]
a	b							
ø1/8"	ø5/32"	KQG2H01-03-F	9	25.6	12	12.6	3.4	6.5
ø5/32"	ø1/4"	KQG2H03-07-F	12	27.1	12.6	13.5	5.6	11.3
ø1/4"	ø5/16"	KQG2H07-09-F	14	30.6	13.5	16.1	13.1	16.1
ø5/16"	ø3/8"	KQG2H09-11-F	16	33.7	16.1	16.6	26.1	22.8
ø3/8"	ø1/2"	KQG2H11-13-F	20	36.1	16.6	18.5	41.5	37.1

*1 Value of FEP tubing

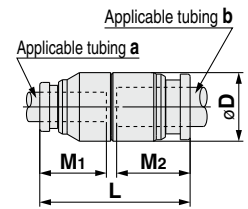

Different Diameter Union "Y": KQG2U



Applicable tubing O.D. [inch]		Model	øD	L1	L2	P	W	M1	M2	øN	øO	Effective area [mm ²] ^{*1}	Weight [g]
a	b												
ø1/8"	ø5/32"	KQG2U01-03-F	9.1	27	10.8	8.1	16.4	12	12.6	3.2	5.6	3.2	8.5
ø5/32"	ø1/4"	KQG2U03-07-F	11.7	28.8	11.4	9.1	18.2	12.6	13.5	3.2	5.6	4.2	11.8
ø1/4"	ø5/16"	KQG2U07-09-F	13.7	33.8	12	12.2	23.9	13.5	16.1	4.2	8	13.4	20
ø5/16"	ø3/8"	KQG2U09-11-F	16	38.3	13.8	14.6	28.3	16.1	16.6	4.2	8	25.6	31
ø3/8"	ø1/2"	KQG2U11-13-F	19.6	40.5	13.7	17.2	33.2	16.6	18.5	4.2	8	40	45

*1 Value of FEP tubing

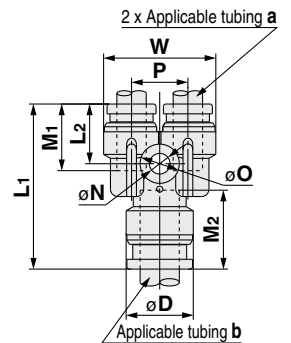

Bulkhead Connector: KQG2E

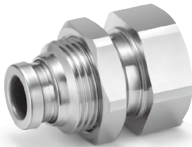

Applicable tubing O.D. [inch]	Connection thread NPT	Model	T (UNF)	Width across flats		L1	L2	Mounting hole	M	Effective area [mm ²] ^{*1}	Weight [g]
				H1	H2						
ø1/8"	1/4	KQG2E01-N02-F	7/16-20UNF	17	14	32.8	15.3	12.5	12	3.4	30.6
ø5/32"	1/4	KQG2E03-N02-F	7/16-20UNF	17	14	32.6	15.3	12.5	12.6	5.6	30.1
ø1/4"	1/4	KQG2E07-N02-F	1/2-20UNF	17	17	32.7	14.8	14	13.5	13.1	32.6
ø5/16"	3/8	KQG2E09-N03-F	5/8-18UNF	19	19	35	15.1	17	16.1	26.1	38.2
ø3/8"	3/8	KQG2E11-N03-F	3/4-16UNF	21	22	33.8	13.3	20.5	16.6	41.5	51.7
ø1/2"	3/8	KQG2E13-N03-F	7/8-14UNF	24	26	34.6	12.3	23.5	18.5	58.3	73.2
	1/2	KQG2E13-N04-F				41.4	19.1				74.7

*1 Value of FEP tubing

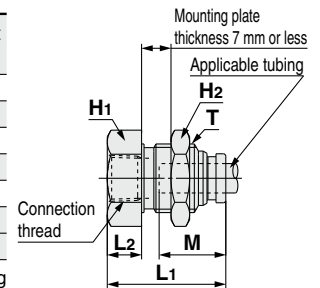

Extended Male Elbow: KQG2W



Applicable tubing O.D. [inch]	Connection thread NPT	Model	H (Width across flats)	øD	L1	L2	A ^{*1}	M	Effective area [mm ²] ^{*2}	Weight [g]
	1/4	KQG2W01-N02-F	14	35.4	35.1	34.4				
ø5/32"	1/8	KQG2W03-N01-F	12	9.1	14.4	32	33.3	12.6	4	22.4
		1/4	KQG2W03-N02-F			14	35.8			35.9
ø1/4"	1/8	KQG2W07-N01-F	12	11.7	15.9	33.3	35.9	13.5	10.9	24.1
		1/4	KQG2W07-N02-F			14	37.1			38.5
ø5/16"	3/8	KQG2W07-N03-F	19	13.7	19.1	38.9	40	16.1	20.5	70.9
		1/8	KQG2W09-N01-F			12	18.6			34.7
ø1/2"	1/4	KQG2W09-N02-F	14	19.6	23.7	40.2	42.6	18.5	47.7	38.7
		3/8	KQG2W09-N03-F			19	42			44.1
ø3/8"	1/4	KQG2W11-N02-F	14	16	21	47.2	50.8	16.6	33.5	41.8
		3/8	KQG2W11-N03-F			19	45.4			48.7
ø1/2"	1/2	KQG2W11-N04-F	22	19.6	23.7	49.2	50.8	18.5	47.7	116.5
		1/4	KQG2W13-N02-F			14	22.7			49
ø1/2"	3/8	KQG2W13-N03-F	19	19.6	23.7	50.7	55.8	18.5	47.7	75.3
		1/2	KQG2W13-N04-F			22	54.5			57.9

*1 Reference dimensions after installation of NPT thread

*2 Value of FEP tubing

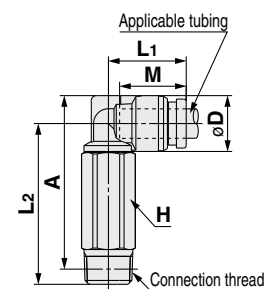

EHEHG Compliant

Metric M, G KFG2H□-E

Clean Design

Metric M, G KFG2H□-C

FDA Compliant

Metric M, R, Rc KQG2-F

Inch UNF, NPT KQG2-F

Metric G KQG2-F

Metric M, R, Rc KQB2-F

Inch UNF, NPT KQB2-F

Metric G KQB2-F

Metric R, Rc KFG2-F

Inch NPT KFG2-F

Metric G KFG2-F

Precautions

KQG2-F Series

Applicable Tubing: Inch Size, Connection Thread: UNF, NPT

Dimensions

Female Connector: KQG2F



Applicable tubing O.D. [inch]	Connection thread NPT	Model	H (Width across flats)	øD*1	L1	L2	M	Effective area [mm ²]*2	Weight [g]
ø1/8"	1/8	KQG2F01-N01-F	12	8	24.1	10.4	12	3.4	9.4
	1/4	KQG2F01-N02-F	17		29.1	13.7			22.5
ø5/32"	1/8	KQG2F03-N01-F	12	8.7	24.6	10.5	12.6	5.6	9.9
	1/4	KQG2F03-N02-F	17		29.6	13.8			23
ø1/4"	1/8	KQG2F07-N01-F	12	11.2	25	10.7	13.5	13.1	11.1
	1/4	KQG2F07-N02-F	17		30	14.1			24.5
	3/8	KQG2F07-N03-F	19		31.2	14.6			25.5
ø5/16"	1/8	KQG2F09-N01-F	14	13.4	27.2	10.3	16.1	26.1	17.3
	1/4	KQG2F09-N02-F	17		32.2	14.3			26.9
	3/8	KQG2F09-N03-F	19		33.4	14.8			28.1
ø3/8"	1/4	KQG2F11-N02-F	17	16	32.1	14.4	16.6	41.5	29.7
	3/8	KQG2F11-N03-F	19		33.3	14.9			30.9
	1/2	KQG2F11-N04-F	24		38.6	18.6			49.1
ø1/2"	3/8	KQG2F13-N03-F	21	19.3	34.6	14.7	18.5	58.3	43.3
	1/2	KQG2F13-N04-F	24		39.9	18.8			53.5

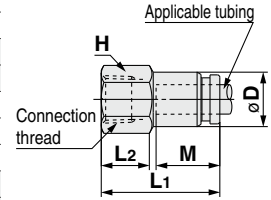

*1 For the ø3/8", this dimension refers to the O.D. of the release button.
*2 Value of FEP tubing

Plug: KQG2P



Applicable fitting size ød	Model	øD	L	A	Weight [g]
ø1/8"	KQG2P-01	5	28.9	16.9	2.7
ø5/32"	KQG2P-03	6	29.6	17	4.1
ø1/4"	KQG2P-07	8	30.3	16.8	8.9
ø5/16"	KQG2P-09	10	33.7	17.6	15.5
ø3/8"	KQG2P-11	11	34.1	17.5	21
ø1/2"	KQG2P-13	14	36.4	17.9	38.5

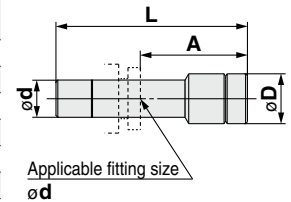

FDA Compliant Fittings

Stainless Steel 316 One-touch Fittings

Applicable Tubing: Metric Size, Connection Thread: G*¹

KQG2-F Series

*1 ISO 16030 compliant



Applicable Tubing

Tubing material* ¹	FEP, PFA, Nylon, Soft nylon, Polyurethane, Polyolefin
Tubing O.D.	ø4, ø6, ø8, ø10, ø12, ø16

*1 Considering the product application, FDA-compliant products are recommended.

Specifications

Fluid	Air, Water* ¹ , Steam* ²
Operating pressure range* ³	-100 kPa to 1 MPa* ⁴
Proof pressure	3.0 MPa
Ambient and fluid temperatures* ⁵	-5 to 150°C (No freezing)* ⁴
Lubricant	NSF H1 grease
Seal on the threads	O-ring seal

*1 Deionized water is not recommended for use as it may affect the material used in the fittings. In addition, it is known to degrade the water quality.

*2 Please contact SMC for applicable tubing separately.

*3 Do not use the fittings with a leak tester or for vacuum retention because they are not guaranteed for zero leakage.

*4 Check the operating pressure range and operating temperature range of the tubing.

*5 It is recommended that you use the inner sleeve in the following conditions.
 · When using in an environment where the fluid temperature changes drastically
 · When using at a high temperature

* Temperature Condition of Mounting the Inner Sleeve

Tubing	Temperature
FEP tubing/TH series	80°C or more
Super PFA tubing/TL series	120°C or more

Spare Parts

Description	Tubing O.D.	Part no.	Material
Bulkhead nut	ø4	KQG223-P01	Stainless steel 316
	ø6	KQG206-P01	
	ø8	KQG208-P01	
	ø10	KQG210-P01	
	ø12	KQG212-P01	
	ø16	KQG216-P01	

Description	Thread size	Part no.	Material
G thread O-ring	G1/8	KQB2-G01-F	FDA compliant FKM
	G1/4	KQB2-G02-F	
	G3/8	KQB2-G03-F	
	G1/2	KQB2-G04-F	

Cross Reference Table of the Inner Sleeve

Tubing O.D.	Tubing material			Applicable inner sleeve	
	TUS (Soft polyurethane)	TH/THH (FEP)	TL/TIL (Super PFA)	Part no.	Length
ø4	—	TH0402	—	TJG-0402	18
	TUS0425	TH0425	—	TJG-0425	18
	—	—	TL0403	TJG-0403	18
ø6	TUS0604	TH0604	TL0604	TJG-0604	19
	TUS0805	—	—	TJG-0805	20.5
ø8	—	TH0806	TL0806	TJG-0806	20.5
	TUS1065	—	—	TJG-1065	23
ø10	—	TH1075	—	TJG-1075	23
	—	TH1008	TL1008	TJG-1008	23
	TUS1208	—	—	TJG-1208	24
ø12	—	TH1209	—	TJG-1209	24
	—	TH1210	TL1210	TJG-1210	24

* Stainless steel 316 is used for the TJG series.

EHDG Compliant

Metric M, G KFG2H-E

Clean Design

Metric M, G KFG2H-C

FDA Compliant

Metric M, R, Rc KQG2-F

Inch UNF, NPT KQG2-F

Metric G KQG2-F

Metric M, R, Rc KQB2-F

Inch UNF, NPT KQB2-F

Metric G KQB2-F

Metric R, Rc KFG2-F

Inch NPT KFG2-F

Metric G KFG2-F

Precautions

KQG2-F Series

Applicable Tubing: Metric Size, Connection Thread: G

How to Order

KQG2 H 04 - G 02 - F

• Body type

Symbol	Model
H	Male connector
S	Hexagon socket head male connector
L	Male elbow
T	Male branch tee
E	Bulkhead connector
W	Extended male elbow
F	Female connector

• FDA compliant

• Thread size

Symbol	Size
01	G1/8
02	G1/4
03	G3/8
04	G1/2

• Tubing size (Metric)

Symbol	Size
04	ø4
06	ø6
08	ø8
10	ø10
12	ø12
16	ø16

• Thread type

Symbol	Type
G	G

Construction

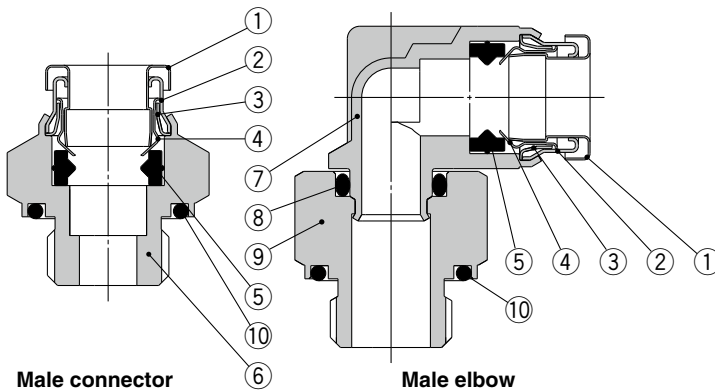

Component Parts

No.	Description	Material
1	Release button	Stainless steel 316
2	Guide 1	Stainless steel 316
3	Guide 2	Stainless steel 316
4	Chuck	Stainless steel 316
5	Seal	FDA compliant FKM (NSF H1 grease)
6	Male connector body	Stainless steel 316
7	Male elbow body	Stainless steel 316 (NSF H1 grease)
8	O-ring	FDA compliant FKM (NSF H1 grease)
9	Stud	Stainless steel 316
10	G thread O-ring	FDA compliant FKM

Stainless Steel 316 One-touch Fittings **KQG2-F Series**

Applicable Tubing: Metric Size, Connection Thread: G

Dimensions

Male Connector: KQG2H



Applicable tubing O.D. [mm]	Connection thread G	Model	H (Width across flats)	øD	ød	L	A	M	Effective area [mm ²] ^{*1}	Weight [g]
ø4	1/8	KQG2H04-G01-F	14	—	13.8	16.6	11.1	12.6	5.6	8.2
	1/4	KQG2H04-G02-F	19		17.8	20.6	14.1			22
ø6	1/8	KQG2H06-G01-F	14	—	13.8	17.6	12.1	13.6	13.1	8.6
	1/4	KQG2H06-G02-F	19		17.8	20.5	14			20.6
ø6	3/8	KQG2H06-G03-F	22	—	21.8	23.4	15.9	16.1	26.1	36.4
	1/8	KQG2H08-G01-F	14		13.8	23.9	18.4			12.7
	1/4	KQG2H08-G02-F	19		17.8	21.2	14.7			18.3
ø8	3/8	KQG2H08-G03-F	22	—	21.8	24	16.5	17	41.5	33.6
	1/8	KQG2H10-G01-F	17		13.8	25.1	19.6			19.1
	1/4	KQG2H10-G02-F	19		17.8	24.9	18.4			23.8
ø10	3/8	KQG2H10-G03-F	22	—	21.8	23.3	15.8	18.6	58.3	29.5
	1/2	KQG2H10-G04-F	27		26.5	27.7	18.7			61.1
	1/4	KQG2H12-G02-F	19		17.8	27.7	21.2			25.3
ø12	3/8	KQG2H12-G03-F	22	—	21.8	23.5	16	20.8	81	24.5
	1/2	KQG2H12-G04-F	27		26.5	27.9	18.9			55.1
	3/8	KQG2H16-G03-F	24		24.6	21.8	31.3			23.8
1/2	KQG2H16-G04-F	27	26.5	27.3		18.3	113	41		

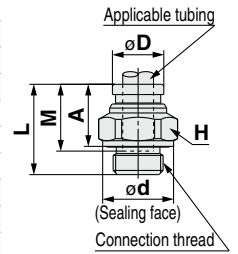

*1 Value of FEP tubing
Value of nylon tubing for ø16 only

Hexagon Socket Head Male Connector: KQG2S



Applicable tubing O.D. [mm]	Connection thread G	Model	H (Width across flats)	øD	ød	L	A	M	Effective area [mm ²] ^{*1}	Weight [g]
ø4	1/8	KQG2S04-G01-F	3	14	14	20.4	14.9	12.6	4.1	13
ø6	1/8	KQG2S06-G01-F	4	14	14	20.6	15.1	13.6	10	11.6
	1/4	KQG2S06-G02-F					14.1		10.7	19.1
ø8	1/8	KQG2S08-G01-F	5	14	14	23.9	18.4	16.1	17.2	11.9
	1/4	KQG2S08-G02-F	6	18	18	22.9	16.4		19.2	
	3/8	KQG2S08-G03-F		22	22	23.1	15.6		29.7	
ø10	1/8	KQG2S10-G01-F	5	17	14	25.1	19.6	17	17.2	17.6
	1/4	KQG2S10-G02-F	8	18	18	24.9	18.4		39	19.6
	3/8	KQG2S10-G03-F		22	22	24	16.5			29.8
	1/2	KQG2S10-G04-F		27	26.5	15	43.1			
1/4	KQG2S12-G02-F	8		19	18	27.7	21.2	46		22.7
ø12	3/8	KQG2S12-G03-F	10	22	22	24.9	17.4	18.6	60	26.3
	1/2	KQG2S12-G04-F		27	26.5		15.9			40.5
	3/8	KQG2S16-G03-F		10	24.6		22			31.3
ø16	1/2	KQG2S16-G04-F	12	27	26.5	27.8	18.8	20.8	113	40.9

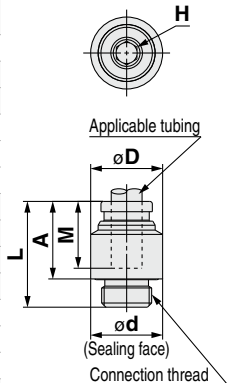

*1 Value of FEP tubing
Value of nylon tubing for ø16 only

EHEDG Compliant

Metric M, G
KFG2H□-E

Clean Design

Metric M, G
KFG2H□-C

FDA Compliant

Metric M, R, Rc
KQG2-F

Inch UNF, NPT
KQG2-F

Metric G
KQG2-F

Metric M, R, Rc
KQB2-F

Inch UNF, NPT
KQB2-F

Metric G
KQB2-F

Metric R, Rc
KFG2-F

Inch NPT
KFG2-F

Metric G
KFG2-F

Precautions

KQG2-F Series

Applicable Tubing: Metric Size, Connection Thread: G

Dimensions

Male Elbow: KQG2L



Applicable tubing O.D. [mm]	Connection thread G	Model	H (Width across flats)	øD*1	ød	L1	L2	A	M	Effective area [mm ²]*2	Weight [g]
ø4	1/8	KQG2L04-G01-F	14	9.1	13.8	14.4	18.9	17.9	12.6	4.2	15
	1/4	KQG2L04-G02-F	19		17.8		22.3	20.3			32.2
ø6	1/8	KQG2L06-G01-F	14	11.4	13.8	15.9	20	20.2	13.6	11.4	16.6
	1/4	KQG2L06-G02-F	19		17.8		23.4	22.6			33.8
	3/8	KQG2L06-G03-F	22		21.8		25.9	24.1			52.8
ø8	1/8	KQG2L08-G01-F	14	13.7	13.8	18.6	21.3	22.6	16.1	21.6	19.6
	1/4	KQG2L08-G02-F	19		17.8		24.7	25			34.6
	3/8	KQG2L08-G03-F	22		21.8		27.2	26.5			53.2
ø10	1/8	KQG2L10-G01-F	14	16.6	13.8	20	22.7	25.5	17	21.6	25.2
	1/4	KQG2L10-G02-F	19		17.8		26.1	27.9			37
	3/8	KQG2L10-G03-F	22		21.8		28.6	29.4			55.1
	1/2	KQG2L10-G04-F	27		26.5		32.6	31.9			94.7
ø12	1/4	KQG2L12-G02-F	19	18.7	17.8	22.6	27.2	30	18.6	50.2	40.8
	3/8	KQG2L12-G03-F	22		21.8		29.6	31.4			52.5
	1/2	KQG2L12-G04-F	27		26.5		33.6	33.9			90.5
ø16	3/8	KQG2L16-G03-F	22	24.6	21.8	26.3	32.4	36.5	20.8	71	63
	1/2	KQG2L16-G04-F	27		26.5		27.3	36.4			39

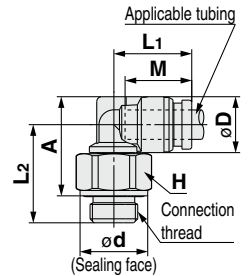

*1 For the ø16, this dimension refers to the O.D. of the release button.

*2 Value of FEP tubing
Value of nylon tubing for ø16 only

Male Branch Tee: KQG2T



Applicable tubing O.D. [mm]	Connection thread G	Model	H (Width across flats)	øD*1	ød	L1	L2	A	M	Effective area [mm ²]*2	Weight [g]
ø4	1/8	KQG2T04-G01-F	14	9.1	13.8	14.4	18.9	17.9	12.6	6	16.9
	1/4	KQG2T04-G02-F	19		17.8		22.3	20.3			34.2
ø6	1/8	KQG2T06-G01-F	14	11.4	13.8	15.9	20	20.2	13.6	13.9	19.9
	1/4	KQG2T06-G02-F	19		17.8		23.4	22.6			37.2
	3/8	KQG2T06-G03-F	22		21.8		25.9	24.1			56.2
ø8	1/8	KQG2T08-G01-F	14	13.7	13.8	18.6	21.3	22.6	16.1	26.3	25
	1/4	KQG2T08-G02-F	19		17.8		24.7	25			39.8
	3/8	KQG2T08-G03-F	22		21.8		27.2	26.5			58.4
ø10	1/8	KQG2T10-G01-F	14	16.6	13.8	20	22.7	25.5	17	40.8	33.4
	1/4	KQG2T10-G02-F	19		17.8		26.1	27.9			44.8
	3/8	KQG2T10-G03-F	22		21.8		28.6	29.4			62.9
	1/2	KQG2T10-G04-F	27		26.5		32.6	31.9			102.6
ø12	1/4	KQG2T12-G02-F	19	18.7	17.8	22.6	27.2	30	18.6	57.2	51.5
	3/8	KQG2T12-G03-F	22		21.8		29.6	31.4			58.1
	1/2	KQG2T12-G04-F	27		26.5		33.6	33.9			100.6
ø16	3/8	KQG2T16-G03-F	22	24.6	21.8	26.3	32.4	36.5	20.8	71	80.4
	1/2	KQG2T16-G04-F	27		26.5		27.3	36.4			39

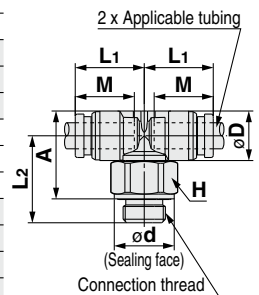

*1 For the ø16, this dimension refers to the O.D. of the release button.

*2 Value of FEP tubing
Value of nylon tubing for ø16 only

Stainless Steel 316 One-touch Fittings **KQG2-F Series**

Applicable Tubing: Metric Size, Connection Thread: G

Dimensions

Bulkhead Connector: KQG2E



Applicable tubing O.D. [mm]	Connection thread G	Model	T (M)	Width across flats		L1	L2	Mounting hole	M	Effective area [mm ²]*1	Weight [g]
				H1	H2						
ø4	1/8	KQG2E04-G01-F	M10 x 1	17	12	27.1	11	11	12.6	5.6	23.8
	1/4	KQG2E04-G02-F		19		32.7	16.6				34.9
ø6	1/8	KQG2E06-G01-F	M14 x 1	17		25.5	7.4	15	13.6	13.1	26
	1/4	KQG2E06-G02-F		19	17	33.5	15.4				39.9
ø6	3/8	KQG2E06-G03-F		24		35	16.9				57.8
	1/8	KQG2E08-G01-F	M15 x 1	17		27.6	8.2	16	16.1	26.1	29.6
1/4	KQG2E08-G02-F	19		19	34.5	15.1	40.3				
ø8	3/8	KQG2E08-G03-F		24		36	16.6				58.1
	1/4	KQG2E10-G02-F	M18 x 1	19		33.5	13.5	19	17	41.5	45.1
3/8	KQG2E10-G03-F	24		21	35.6	15.6	61.4				
ø12	3/8	KQG2E12-G03-F	M20 x 1	24	24	35.9	14.7	21	18.6	58.3	65.7
	1/2	KQG2E12-G04-F		27		42.2	21				88.5
ø16	3/8	KQG2E16-G03-F	M27 x 1	29	30	37.2	13.1	28	20.8	96	114.7
	1/2	KQG2E16-G04-F		43.1	19						113

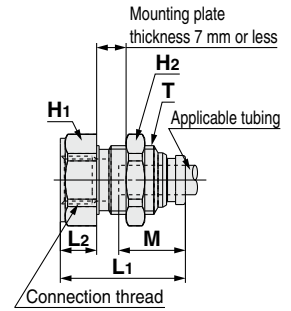

*1 Value of FEP tubing
Value of nylon tubing for ø16 only

Extended Male Elbow: KQG2W



Applicable tubing O.D. [mm]	Connection thread G	Model	H (Width across flats)	øD*1	ød	L1	L2	A	M	Effective area [mm ²]*2	Weight [g]
1/4	KQG2W04-G02-F	19		17.8		38.7	36.7	68.6			
ø6	1/8	KQG2W06-G01-F	14	11.4	13.8		36.4	36.6	13.6	10.9	34.5
	1/4	KQG2W06-G02-F	19		17.8	15.9	39.8	39			70.2
ø6	3/8	KQG2W06-G03-F	22		21.8		42.3	40.5			102.9
	1/8	KQG2W08-G01-F	14	13.7	13.8	18.6	40	41.3	16.1	20.5	39.6
1/4	KQG2W08-G02-F	19	17.8		19.1	43.4	43.7	73.1			
ø8	3/8	KQG2W08-G03-F	22		21.8		45.9	45.2			107.4
	1/4	KQG2W10-G02-F	19	16.6	17.8		49.8	51.6	17	33.5	81.1
3/8	KQG2W10-G03-F	22	21.8		21	50.2	51	113.6			
ø10	1/2	KQG2W10-G04-F	27		26.5		54.2	53.5			189.8
	1/4	KQG2W12-G02-F	19	18.7	17.8	22.6	50.9	53.7	18.6	47.7	85
3/8	KQG2W12-G03-F	22	21.8		23.6	53.3	55.1	106.8			
ø12	1/2	KQG2W12-G04-F	27		26.5		57.3	57.6			184.8
	3/8	KQG2W16-G03-F	22	24.6	21.8	26.3	62	66.1	20.8	71	128.2
1/2	KQG2W16-G04-F	27	26.5		27.3	66	68.6	192.9			

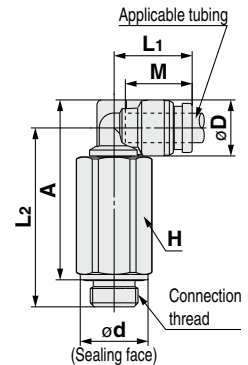

*1 For the ø16, this dimension refers to the O.D. of the release button.
*2 Value of FEP tubing
Value of nylon tubing for ø16 only

Female Connector: KQG2F



Applicable tubing O.D. [mm]	Connection thread G	Model	H1 (Width across flats)	øD*1	L1	L2	M	Effective area [mm ²]*2	Weight [g]
1/4	KQG2F04-G02-F	19		30.6	14.5	30.4			
ø6	1/8	KQG2F06-G01-F	17	11.1	25.5	9.7	13.6	13.1	21.4
	1/4	KQG2F06-G02-F	19		31.1	14.7			32
ø6	3/8	KQG2F06-G03-F	24		32.6	14.6			48.5
	1/8	KQG2F08-G01-F	17	13.4	27.6	10	16.1	26.1	23.8
1/4	KQG2F08-G02-F	19	33.2		14.9	34.5			
ø8	3/8	KQG2F08-G03-F	24		34.6	14.7			51
	1/4	KQG2F10-G02-F	19	16.4	33.5	15.2	17	41.5	37.9
3/8	KQG2F10-G03-F	24	34.9		15	54.8			
ø10	1/4	KQG2F12-G02-F	19	18.5	34.5	15.2	18.6	58.3	39.8
	3/8	KQG2F12-G03-F	24		35.9	15			56.7
ø12	1/2	KQG2F12-G04-F	27		41.8	19.9			77.5
	3/8	KQG2F16-G03-F	24	24.6	37.2	15.4	20.8	81	63.3
1/2	KQG2F16-G04-F	27	43.1		20.4	113			84.7

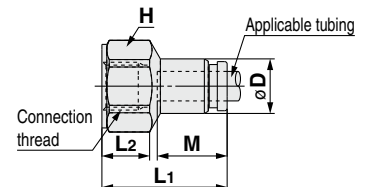

*1 For the ø10, ø12, and ø16, this dimension refers to the O.D. of the release button.
*2 Value of FEP tubing
Value of nylon tubing for ø16 only

EHDG Compliant

Metric M, G KFG2H□-E

Clean Design

Metric M, G KFG2H□-C

FDA Compliant

Metric M, R, Rc KQG2-F

Inch UNF, NPT KQG2-F

Metric G KQG2-F

Metric M, R, Rc KQB2-F

Inch UNF, NPT KQB2-F

Metric G KQB2-F

Metric R, Rc KFG2-F

Inch NPT KFG2-F

Metric G KFG2-F

Precautions

Specific Product Precautions

Be sure to read this before handling the products. Refer to the back cover for safety instructions and pages 75 to 79 for fittings & tubing precautions.



Selection

⚠ Caution

1. The surge pressure must be under the maximum operating pressure. If the surge pressure exceeds the maximum operating pressure, it will result in damage to fittings and tubing or the tubing may result in being fallen out.
2. If using a fluororesin tubing in an environment where the fluid temperature changes drastically, it is recommended to use an inner sleeve. Otherwise, air leakage may occur or the tube may release from fitting due to deformation of the tubing.
3. The particle generation of the KQG2-F series depends on the operating conditions and operating environment. If you are concerned about the effects on machinery and equipment, check the particle generation with your machine before use.
The components of the KQG2-F series may slide due to changes in the internal pressure, which may generate particles. When using male elbow, male branch tee, and extended male elbow fittings, particles may be generated by rotation for positioning after connecting.

Mounting

⚠ Caution

1. When performing the piping work, turn the tightening tool in the horizontal direction to the hexagon across flats of the stud so that any moment is not applied to the body.
If the tool is in contact with the body, this may cause the stud to come off.

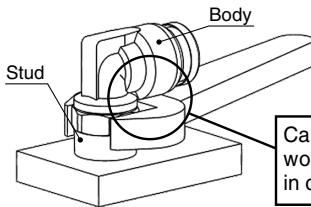

2. The union elbow, union tee, union "Y", different diameter tee and different diameter union "Y" should be fixed through the mounting hole. Otherwise, air leakage or breaking can occur due to a pulling force or moment load created by the product's weight.
3. The male elbow, male branch tee, and extended male elbow can be turned for positioning after connecting, but they cannot be used while turning them.
Doing so may cause worn out metallic particles to enter the fluid or the fitting to break.
4. If the connection tube oscillates or turns, do not use this product.
Doing so may cause the fitting to break. In particular, for the product with the stud, this may cause the stud to come off.

Cleaning Method

⚠ Warning

1. Check the connection before cleaning.
Clean the fittings with the tube and plug connected and the screw tightened.
2. Review the conditions before cleaning.
Make sure that the fitting material is not affected or damaged by chemical solution, temperature, and water pressure before use.
3. Do not use a metal brush or tool that may damage or scratch the fitting.

Operating Environment

⚠ Caution

1. The table below shows material of parts. Please refer to the relevant standards for parts when determining suitability in applications and operating conditions.

Item	Material	Compliant standards
Pressing parts	Stainless steel	AISI316
Cutting parts	Stainless steel	AISI316
MIM parts	Stainless steel	AISI316L equivalent
Rubber parts	Fluoropolymer	FDA 21CFR 177.2600
Grease	Paraffin oil	NSF H1

Installation and Removal of Tubing

⚠ Caution

1. Removal of tubing
1) For tubing used at a high temperature or for an extended period of time, there is a possibility that it will not fit into a One-touch fitting again due to an enlarged O.D. Dispose of the tubing and replace it with a new one.

Proper Tightening Torque of Fittings

⚠ Caution

1. Connection thread tightening method: M5, 10-32UNF
Tighten fittings with a tightening torque of 1 to 1.5 N-m.
2. Connection thread tightening method: G
Tighten fittings with sealant using the proper tightening torques in the table below. If tightened using a torque exceeding the proper torque level, this may cause the fitting to break. In particular, for the product with the stud, the stud may come off.

G Thread Proper Tightening Torque

Connection thread size	Proper tightening torque [N-m]
G1/8	2.9 to 3.2
G1/4	5.7 to 6.3
G3/8	9.5 to 10.5
G1/2	14.3 to 15.8

Stainless steel

Metal exists in nature as ore (like oxide or sulfide). This means that oxide or sulfide is more stable than pure metal. Accordingly, metallic material chemically oxidizes (metallic constituent becomes ion and melts out). It corrodes in the natural environment.

Even though corrosion of metal easily occurs in an environment where oxidizing tendency is stronger, some kinds of metal have a characteristic for which corrosion never happens if the level of oxidizing goes higher than a specific point. In such a case, it is called "metal in passive state". Stainless steel has corrosion resistance because of a thin coat of passive state on its surface. However, there does not exist stainless steel with absolute corrosion resistance; therefore, many types of stainless steel have been developed for improved corrosion resistance performance.

Variations

Male Connector KQB2H

Metric	R thread	p. 39
	G thread	p. 54
Inch		p. 47



Bulkhead Union KQB2E

Metric	p. 41
Inch	p. 49



Different Diameter Union "Y" KQB2U

Metric	p. 42
Inch	p. 50



Hexagon Socket Head Male Connector KQB2S

Metric	R thread	p. 39
	G thread	p. 54
Inch		p. 47



Union Tee KQB2T

Metric	p. 41
Inch	p. 49



Bulkhead Connector KQB2E

Metric	Rc thread	p. 43
	G thread	p. 56
Inch		p. 50

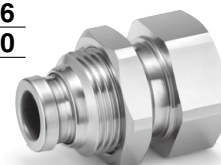

Straight Union KQB2H

Metric	p. 39
Inch	p. 47



Union "Y" KQB2U

Metric	p. 41
Inch	p. 49



Extended Male Elbow KQB2W

Metric	R thread	p. 43
	G thread	p. 56
Inch		p. 50



Male Elbow KQB2L

Metric	R thread	p. 40
	G thread	p. 55
Inch		p. 48



Different Diameter Tee KQB2T

Metric	p. 42
Inch	p. 49



Female Connector KQB2F

Metric	Rc thread	p. 44
	G thread	p. 56
Inch		p. 51



Male Branch Tee KQB2T

Metric	R thread	p. 40
	G thread	p. 55
Inch		p. 48



Plug-in Reducer KQB2R

Metric	p. 42
Inch	p. 49



Plug KQB2P

Metric	p. 44
Inch	p. 51



Union Elbow KQB2L

Metric	p. 41
Inch	p. 48



Different Diameter Straight KQB2H

Metric	p. 42
Inch	p. 50



EHDG
Compliant

Metric M, G
KFG2H-E

Clean
Design

Metric M, G
KFG2H-C

FDA
Compliant

Metric M, R, Rc
KQG2-F

Inch UNF, NPT
KQG2-F

Metric G
KQG2-F

Metric M, R, Rc
KQB2-F

Inch UNF, NPT
KQB2-F

Metric G
KQB2-F

Metric R, Rc
KFG2-F

Inch NPT
KFG2-F

Metric G
KFG2-F

Precautions

Metal One-touch Fittings

Applicable Tubing: Metric Size, Connection Thread: M, R, Rc

KQB2-F Series



Applicable Tubing

Tubing material*1	FEP, PFA, Nylon, Soft nylon, Polyurethane, Polyolefin
Tubing O.D.	ø3.2, ø4, ø6, ø8, ø10, ø12, ø16

*1 Considering the product application, FDA-compliant products are recommended.

Specifications

Fluid	Air, Water*1
Operating pressure range*2	-100 kPa to 1 MPa*3
Proof pressure	3.0 MPa
Ambient and fluid temperatures*4	-5 to 150°C (No freezing)*3
Lubricant	NSF H1 grease
Seal on the threads	Without sealant

*1 Deionized water is not recommended for use as it may affect the material used in the fittings. In addition, it is known to degrade the water quality.

*2 Do not use the fittings with a leak tester or for vacuum retention because they are not guaranteed for zero leakage.

*3 Check the operating pressure range and operating temperature range of the tubing.

*4 It is recommended that you use the inner sleeve in the following conditions. (Except ø3.2)

- When using in an environment where the fluid temperature changes drastically
- When using at a high temperature

*** Temperature Condition of Mounting the Inner Sleeve**

Tubing	Temperature
FEP tubing/TH series	80°C or more
Super PFA tubing/TL series	120°C or more

Spare Parts

Description	Tubing O.D.	Part no.	Material
O-ring	—	M-5-F	FDA compliant FKM
Bulkhead nut	ø3.2	KQB223-P01-F	C3604 (Electroless nickel plating)
	ø4	KQB206-P01-F	
	ø6	KQB208-P01-F	
	ø8	KQB210-P01-F	
	ø10	KQB212-P01-F	
	ø12	KQB216-P01-F	

Cross Reference Table of the Inner Sleeve

Tubing O.D.	Tubing material			Applicable inner sleeve	
	TUS (Soft polyurethane)	TH/THI (FEP)	TL/TIL (Super PFA)	Part no.	Length
ø4	—	TH0402	—	TJG-0402	18
	TUS0425	TH0425	—	TJG-0425	18
	—	—	TL0403	TJG-0403	18
ø6	TUS0604	TH0604	TL0604	TJG-0604	19
	TUS0805	—	—	TJG-0805	20.5
	—	TH0806	TL0806	TJG-0806	20.5
ø10	TUS1065	—	—	TJG-1065	23
	—	TH1075	—	TJG-1075	23
	—	TH1008	TL1008	TJG-1008	24
ø12	TUS1208	—	—	TJG-1208	24
	—	TH1209	—	TJG-1209	24
	—	TH1210	TL1210	TJG-1210	24

* Stainless steel 316 is used for the TJG series.

How to Order

KQB2 H 04 - 02 - F

Body type

Symbol	Model
H	Male connector, Straight union, Different diameter straight
S	Hexagon socket head male connector
L	Male elbow, Union elbow
T	Male branch tee, Union tee, Different diameter tee
E	Bulkhead union, Bulkhead connector
U	Union "Y", Different diameter union "Y"
R	Plug-in reducer
W	Extended male elbow
F	Female connector
P	Plug

FDA compliant

Thread size, Tubing size

Symbol	Size	
M5	M5 x 0.8	Thread size
01	R1/8, Rc1/8	
02	R1/4, Rc1/4	
03	R3/8, Rc3/8	
04	R1/2, Rc1/2	Tubing size
00	Same tubing O.D.	
04	ø4	
06	ø6	
08	ø8	
10	ø10	
12	ø12	
16	ø16	

Tubing size (Metric)

Symbol	Size
23	ø3.2
04	ø4
06	ø6
08	ø8
10	ø10
12	ø12
16	ø16

* Sealant is unavailable for this product as no FDA-compliant material is available.

Construction

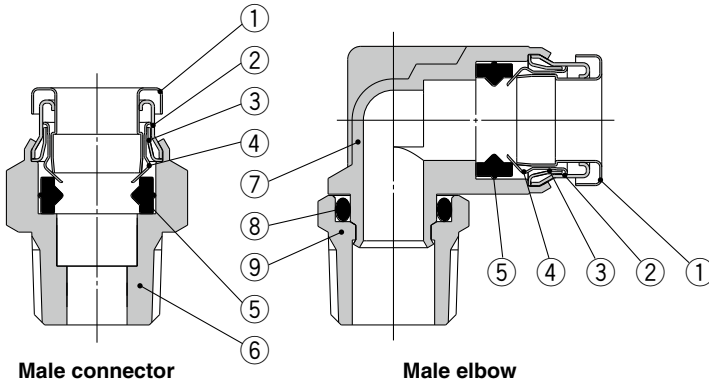

Component Parts

No.	Description	Material
1	Release button	Stainless steel 304
2	Guide 1	Stainless steel 304
3	Guide 2	Stainless steel 304
4	Chuck	Stainless steel 304
5	Seal	FDA compliant FKM (NSF H1 grease)
6	Male connector body	C3604 (Electroless nickel plating)
7	Male elbow body	Stainless steel 316
8	O-ring	FDA compliant FKM (NSF H1 grease)
9	Stud	C3604 (Electroless nickel plating)

EHEDG
Compliant

Metric M, G
KFG2H□-E

Clean
Design

Metric M, G
KFG2H□-C

FDA
Compliant

Metric M, R, Rc
KQG2-F

Inch UNF, NPT
KQG2-F

Metric G
KQG2-F

Metric M, R, Rc
KQB2-F

Inch UNF, NPT
KQB2-F

Metric G
KQB2-F

Metric R, Rc
KFG2-F

Inch NPT
KFG2-F

Metric G
KFG2-F

Precautions

KQB2-F Series

Applicable Tubing: Metric Size, Connection Thread: M, R, Rc

Dimensions

Male Connector: KQB2H



Applicable tubing O.D. [mm]	Connection thread R, M	Model	H (Width across flats)	øD	ød	L	A*1	M	Effective area [mm ²]*2	Weight [g]			
ø3.2	M5 x 0.8	KQB2H23-M5-F	8	—	8	17.8	13.8	12	3	3.7			
	1/8	KQB2H23-01-F	10								15.4	13.6	6
	1/4	KQB2H23-02-F	14								21	17.6	17.8
ø4	M5 x 0.8	KQB2H04-M5-F	10	—	8	18.4	14.4	12.6	4	5.7			
	1/8	KQB2H04-01-F	10								15.3	13.5	5.6
	1/4	KQB2H04-02-F	14								20.9	17.5	17.2
ø6	M5 x 0.8	KQB2H06-M5-F	12	—	8	19.6	15.6	13.6	4	7.8			
	1/8	KQB2H06-01-F	12								18.1	16.3	7.3
	1/4	KQB2H06-02-F	14								20.8	17.4	15.2
	3/8	KQB2H06-03-F	17								23	19.2	28.8
ø8	1/8	KQB2H08-01-F	14	—	—	24.5	22.7	16.1	26.1	13.5			
	1/4	KQB2H08-02-F	14								22.3	18.9	26
	3/8	KQB2H08-03-F	17								23.7	19.9	26
ø10	1/8	KQB2H10-01-F	17	—	—	25.5	23.7	17	26.1	19.8			
	1/4	KQB2H10-02-F	17								27.9	24.5	22.7
	3/8	KQB2H10-03-F	17								23	19.2	21.6
	1/2	KQB2H10-04-F	22								28.6	23.5	53.9
ø12	1/4	KQB2H12-02-F	19	—	—	30.5	27.1	18.6	58.3	28.8			
	3/8	KQB2H12-03-F	19								24.7	20.9	21.5
	1/2	KQB2H12-04-F	22								28.7	23.6	47
ø16	3/8	KQB2H16-03-F	24	24.6	—	33.6	29.8	20.8	81	48.3			
	1/2	KQB2H16-04-F	24								29.5	24.4	113

*1 Reference dimensions after installation for R thread
 *2 Value of FEP tubing
 Value of nylon tubing for ø16 only
 *3 In the case of M5, the screw length (L - A) is longer than that of the KQB2 series.

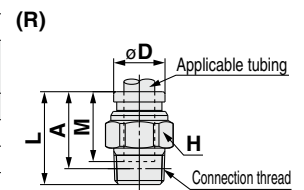
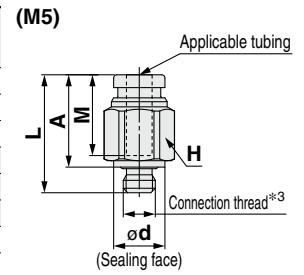

Hexagon Socket Head Male Connector: KQB2S



Applicable tubing O.D. [mm]	Connection thread R, M	Model	H (Width across flats)	øD*1	ød	L	A*2	M	Effective area [mm ²]*3	Weight [g]			
ø3.2	M5 x 0.8	KQB2S23-M5-F	2	9	8	17.8	13.8	12	3	4.3			
ø4	M5 x 0.8	KQB2S04-M5-F	2	9	8	18.4	14.4	12.6	4	4.2			
	1/8	KQB2S04-01-F	3	10	—	20.4	18.6				4.1	7.9	
ø6	M5 x 0.8	KQB2S06-M5-F	2	12	8	20.1	16.1	13.6	4	7.7			
	1/8	KQB2S06-01-F	4								18.8	10	9.1
	1/4	KQB2S06-02-F	4								20.6	17.2	10.7
ø8	1/8	KQB2S08-01-F	5	14	—	24.7	22.9	16.1	17.2	13			
	1/4	KQB2S08-02-F	6								22.9	19.5	13.5
	3/8	KQB2S08-03-F	6								23.1	19.3	24
ø10	1/8	KQB2S10-01-F	5	17	—	25.6	23.8	17	17.2	18.6			
	1/4	KQB2S10-02-F	8								27.5	24.1	20
	3/8	KQB2S10-03-F	8								24	20.2	22
	1/2	KQB2S10-04-F	22								24	18.9	39.2
ø12	1/4	KQB2S12-02-F	8	19	—	30.6	27.2	18.6	46	26			
	3/8	KQB2S12-03-F	10								24.9	21.1	20.2
	1/2	KQB2S12-04-F	10								24.9	19.8	35.3
ø16	3/8	KQB2S16-03-F	10	24.6	—	33.2	29.4	20.8	81	43.6			
	1/2	KQB2S16-04-F	12								29.4	24.3	113

*1 For the ø16, this dimension refers to the O.D. of the release button.
 *2 Reference dimensions after installation for R thread
 *3 Value of FEP tubing
 Value of nylon tubing for ø16 only
 *4 In the case of M5, the screw length (L - A) is longer than that of the KQB2 series.

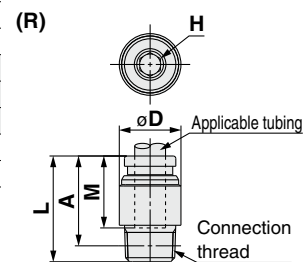
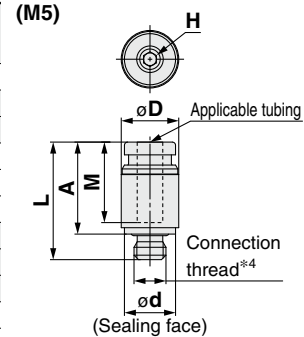

Straight Union: KQB2H



Applicable tubing O.D. [mm]	Model	øD*1	L	M	Effective area [mm ²]*2	Weight [g]
ø3.2	KQB2H23-00-F	9	25	12	3.4	6.8
ø4	KQB2H04-00-F	9	26.2	12.6	5.6	6.8
ø6	KQB2H06-00-F	12	28.2	13.6	13.1	12
ø8	KQB2H08-00-F	14	33.2	16.1	26.1	17.4
ø10	KQB2H10-00-F	17	35	17	41.5	27.2
ø12	KQB2H12-00-F	19	38.2	18.6	58.3	33.7
ø16	KQB2H16-00-F	24.6	42.6	20.8	113	56.1

*1 For the ø16, this dimension refers to the O.D. of the release button.
 *2 Value of FEP tubing
 Value of nylon tubing for ø16 only

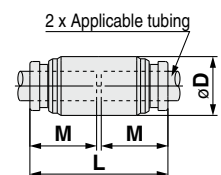

Metal One-touch Fittings **KQB2-F Series**

Applicable Tubing: Metric Size, Connection Thread: M, R, Rc

Dimensions

Male Elbow: KQB2L



Applicable tubing O.D. (mm)	Connection thread R, M	Model	H (Width across flats)	ϕD *1	ϕd	L1	L2	A*2	M	Effective area [mm ²]*3	Weight [g]
$\phi 3.2$	M5 x 0.8	KQB2L23-M5-F	8	8.3	8	13.1	15.9	16.1	12	2.6	6.7
	1/8	KQB2L23-01-F	10			13.6	14.9	17.2		3	8
	1/4	KQB2L23-02-F	14			18.7	19.4	16.6			
$\phi 4$	M5 x 0.8	KQB2L04-M5-F	8	9.1	8	13.7	16.3	16.9	12.6	3.5	7.2
	1/8	KQB2L04-01-F	10			14.4	15.3	18		4.2	8.6
	1/4	KQB2L04-02-F	14			19.1	20.2	17.5			
$\phi 6$	M5 x 0.8	KQB2L06-M5-F	8	11.4	8	14.7	17.4	19.1	13.6	3.5	9.2
	1/8	KQB2L06-01-F	10			16.4	20.3	10.2			
	1/4	KQB2L06-02-F	14			15.9	20.2	22.5		11.4	19.1
	3/8	KQB2L06-03-F	17			21.6	23.5	31.2			
$\phi 8$	1/8	KQB2L08-01-F	12	13.7	8	18.6	18.3	23.3	16.1	21.6	14.8
	1/4	KQB2L08-02-F	14			19.1	21.5	24.9		20.8	
	3/8	KQB2L08-03-F	17			22.9	25.9	32.8			
$\phi 10$	1/8	KQB2L10-01-F	12	16.6	8	20	19.7	26.2	17	21.6	20.4
	1/4	KQB2L10-02-F	14			21	22.9	27.8		23.7	
	3/8	KQB2L10-03-F	17			24.3	28.8	35.2		34.5	
$\phi 12$	1/2	KQB2L10-04-F	22	18.7	8	28.5	31.7	31.7	18.6	50.2	62.6
	1/4	KQB2L12-02-F	14			22.6	24	29.9		27.4	
	3/8	KQB2L12-03-F	17			23.6	25.3	30.8		34.3	
$\phi 16$	1/2	KQB2L12-04-F	22	24.6	8	29.5	33.7	33.7	20.8	71	60.8
	3/8	KQB2L16-03-F	19			26.3	28	35.8		47	
	1/2	KQB2L16-04-F	22			27.3	31.8	38.3		100	62.6

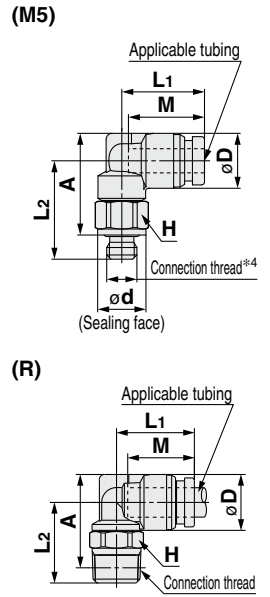

*1 For the $\phi 16$, this dimension refers to the O.D. of the release button.
 *2 Reference dimensions after installation for R thread
 *3 Value of FEP tubing
 Value of nylon tubing for $\phi 16$ only
 *4 In the case of M5, the screw length ($\phi D/2 + L2 - A$) is longer than that of the KQB2 series.

Male Branch Tee: KQB2T



Applicable tubing O.D. (mm)	Connection thread R, M	Model	H (Width across flats)	ϕD *1	ϕd	L1	L2	A*2	M	Effective area [mm ²]*3	Weight [g]
$\phi 3.2$	M5 x 0.8	KQB2T23-M5-F	8	8.3	8	13.1	15.9	16.1	12	3.2	8.4
	1/8	KQB2T23-01-F	10			13.6	14.9	17.2		3.4	9.6
	1/4	KQB2T23-02-F	14			18.7	19.4	18.4			
$\phi 4$	M5 x 0.8	KQB2T04-M5-F	8	9.1	8	13.7	16.3	16.9	12.6	4.5	9.3
	1/8	KQB2T04-01-F	10			14.4	15.3	18		6	10.6
	1/4	KQB2T04-02-F	14			19.1	20.2	19.4			
$\phi 6$	M5 x 0.8	KQB2T06-M5-F	8	11.4	8	14.7	17.4	19.1	13.6	4.5	12.3
	1/8	KQB2T06-01-F	10			16.4	20.3	13.6			
	1/4	KQB2T06-02-F	14			15.9	20.2	22.5		13.9	22.5
	3/8	KQB2T06-03-F	17			21.6	23.5	35			
$\phi 8$	1/8	KQB2T08-01-F	12	13.7	8	18.6	18.3	23.3	16.1	26.3	20
	1/4	KQB2T08-02-F	14			19.1	21.5	24.9		26.1	
	3/8	KQB2T08-03-F	17			22.9	25.9	38			
$\phi 10$	1/8	KQB2T10-01-F	12	16.6	8	20	19.7	26.2	17	40.8	28.6
	1/4	KQB2T10-02-F	14			21	22.9	27.8		31.5	
	3/8	KQB2T10-03-F	17			24.3	28.8	42.4			
$\phi 12$	1/2	KQB2T10-04-F	22	18.7	8	28.5	31.7	31.7	18.6	57.2	70.4
	1/4	KQB2T12-02-F	14			22.6	24	29.9		38.1	
	3/8	KQB2T12-03-F	17			23.6	25.3	30.8		39.7	
$\phi 16$	1/2	KQB2T12-04-F	22	24.6	8	29.5	33.7	33.7	20.8	71	70.8
	3/8	KQB2T16-03-F	19			26.3	28	35.8		64.4	
	1/2	KQB2T16-04-F	22			27.3	31.8	38.3		100	79

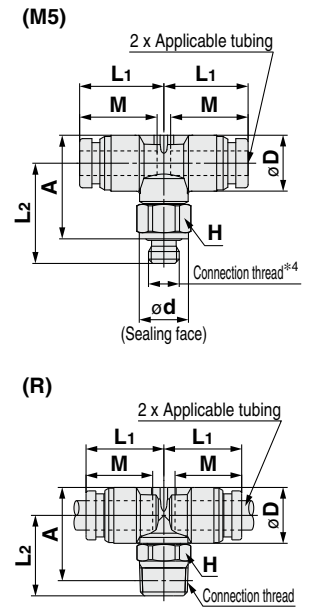

*1 For the $\phi 16$, this dimension refers to the O.D. of the release button.
 *2 Reference dimensions after installation for R thread
 *3 Value of FEP tubing
 Value of nylon tubing for $\phi 16$ only
 *4 In the case of M5, the screw length ($\phi D/2 + L2 - A$) is longer than that of the KQB2 series.

KQB2-F Series

Applicable Tubing: Metric Size, Connection Thread: M, R, Rc

Dimensions

Union Elbow: KQB2L



Applicable tubing O.D. [mm]	Model	øD ^{*1}	L	A	Q	M	øN	øO	Effective area [mm ²] ^{*2}	Weight [g]
ø3.2	KQB2L23-00-F	8.3	13.6	19.3	2.9	12	3.2	5.6	3	6.3
ø4	KQB2L04-00-F	9.1	14.6	20.5	3.1	12.6	3.2	5.6	4.2	7.4
ø6	KQB2L06-00-F	11.4	16.6	23	3.6	13.6	3.2	5.6	11.4	11
ø8	KQB2L08-00-F	13.7	20.1	29.1	5	16.1	4.2	8	21.6	20.2
ø10	KQB2L10-00-F	16.6	22	31.7	5.7	17	4.2	8	35.2	29.6
ø12	KQB2L12-00-F	18.7	24.6	35	6.4	18.6	4.2	8	50.2	37.1
ø16	KQB2L16-00-F	24.6	28.8	40.5	7.7	20.8	4.2	8	100	59.7

*1 For the ø16, this dimension refers to the O.D. of the release button.

*2 Value of FEP tubing

Value of nylon tubing for ø16 only

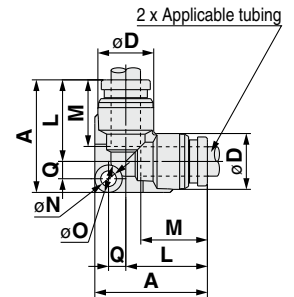

Bulkhead Union: KQB2E



Applicable tubing O.D. [mm]	Model	T (M)	H (Width across flats)	L	Mounting hole	M	Effective area [mm ²] ^{*1}	Weight [g]
ø3.2	KQB2E23-00-F	M10 x 1	12	32.2	11	12	3.4	14.8
ø4	KQB2E04-00-F	M10 x 1	12	32.4	11	12.6	5.6	14.7
ø6	KQB2E06-00-F	M14 x 1	17	35.4	15	13.6	13.1	29.2
ø8	KQB2E08-00-F	M15 x 1	19	38.8	16	16.1	26.1	34.9
ø10	KQB2E10-00-F	M18 x 1	21	40	19	17	41.5	47.1
ø12	KQB2E12-00-F	M20 x 1	24	42.4	21	18.6	58.3	58.7
ø16	KQB2E16-00-F	M27 x 1	30	46.8	28	20.8	113	107.2

*1 Value of FEP tubing

Value of nylon tubing for ø16 only

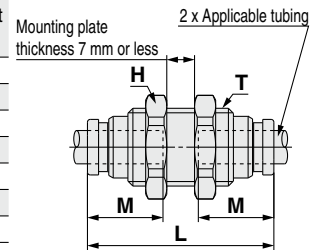

Union Tee: KQB2T



Applicable tubing O.D. [mm]	Model	øD ^{*1}	L	A	Q	M	øN	øO	Effective area [mm ²] ^{*2}	Weight [g]
ø3.2	KQB2T23-00-F	8.3	13.6	20.5	4.1	12	3.2	5.6	3.4	7.9
ø4	KQB2T04-00-F	9.1	14.6	21.8	4.4	12.6	3.2	5.6	6.4	9.5
ø6	KQB2T06-00-F	11.4	16.6	24.6	5.2	13.6	3.2	5.6	13.4	14.2
ø8	KQB2T08-00-F	13.7	20.1	31.1	7	16.1	4.2	8	25.6	24.4
ø10	KQB2T10-00-F	16.6	22	34	8	17	4.2	8	40	36.8
ø12	KQB2T12-00-F	18.7	24.6	37.7	9.1	18.6	4.2	8	57.4	47
ø16	KQB2T16-00-F	24.6	28.8	43.4	10.6	20.8	4.2	8	100	75.5

*1 For the ø16, this dimension refers to the O.D. of the release button.

*2 Value of FEP tubing

Value of nylon tubing for ø16 only

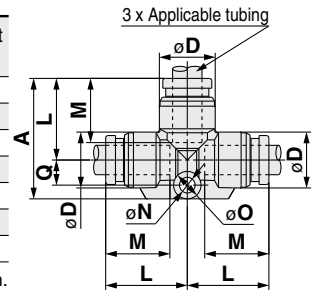

Union "Y": KQB2U



Applicable tubing O.D. [mm]	Model	øD ^{*1}	W	L1	L2	P	M	øN	øO	Effective area [mm ²] ^{*2}	Weight [g]
ø3.2	KQB2U23-00-F	8.3	16.4	29	11	8.1	12	3.2	5.6	3.4	9.2
ø4	KQB2U04-00-F	9.1	18.2	30.4	11.3	9.1	12.6	3.2	5.6	4.2	11.1
ø6	KQB2U06-00-F	11.4	22.9	34.9	12.2	11.5	13.6	3.2	5.6	13.4	18.8
ø8	KQB2U08-00-F	13.7	28.3	40.1	14.1	14.6	16.1	4.2	8	25.6	29.7
ø10	KQB2U10-00-F	16.6	34.2	44	14.4	17.6	17	4.2	8	40	47.4
ø12	KQB2U12-00-F	18.7	38.5	48.4	15.8	19.8	18.6	4.2	8	57.4	62.1
ø16	KQB2U16-00-F	24.6	49.3	56.6	17.3	26	20.8	4.2	8	113	110.2

*1 For the ø16, this dimension refers to the O.D. of the release button.

*2 Value of FEP tubing

Value of nylon tubing for ø16 only

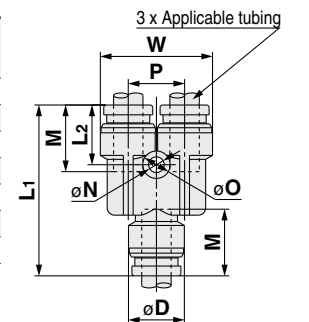

Metal One-touch Fittings **KQB2-F Series**

Applicable Tubing: Metric Size, Connection Thread: M, R, Rc

Dimensions

Different Diameter Tee: KQB2T



Applicable tubing O.D. [mm]		Model	øD ^{*1}	øD ₂	L ₁	L ₂	L ₃	Q	M ₁	M ₂	øN	øO	Effective area [mm ²] ^{*2}	Weight [g]
a	b													
ø3.2	ø4	KQB2T23-04-F	9.1	8.3	14.2	14.1	21.1	4.1	12.6	12	3.2	5.6	3.8	8.5
ø4	ø6	KQB2T04-06-F	11.4	9.1	15.6	15.7	22.8	4.4	13.6	12.6	3.2	5.6	7.1	11
ø6	ø8	KQB2T06-08-F	13.7	11.4	19.1	17.7	29.5	6.4	16.1	13.6	4.2	8	16.4	20
ø8	ø10	KQB2T08-10-F	16.6	13.7	21	21.2	32.1	7.1	17	16.1	4.2	8	36	29.8
ø10	ø12	KQB2T10-12-F	18.7	16.6	23.6	23.1	35.7	8.1	18.6	17	4.2	8	56	41.3
ø12	ø16	KQB2T12-16-F	24.6	18.7	26.8	26.7	39.9	9.1	20.8	18.6	4.2	8	108.5	58

*1 For the ø16, this dimension refers to the O.D. of the release button.
*2 Value of FEP tubing

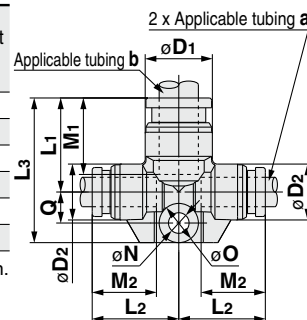

Plug-in Reducer: KQB2R



Applicable tubing O.D. [mm]	Applicable fitting size ød	Model	øD	L	A	M	Effective area [mm ²] ^{*1}	Weight [g]
ø3.2	ø4	KQB2R23-04-F	9	32.9	20.3	12	3.4	4.9
ø4	ø6	KQB2R04-06-F	9	34.4	20.8	12.6	5.6	7
ø6	ø8	KQB2R06-08-F	12	38.4	22.3	13.6	13.1	12.7
ø8	ø10	KQB2R08-10-F	14	41.9	24.9	16.1	26.1	19.2
ø10	ø12	KQB2R10-12-F	17	44.8	26.2	17	41.5	27.8
ø12	ø16	KQB2R12-16-F	19	42.9	22.1	18.6	58.3	37.2

*1 Value of FEP tubing

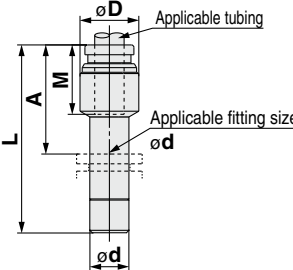

Different Diameter Straight: KQB2H



Applicable tubing O.D. [mm]		Model	øD ^{*1}	L	M ₁	M ₂	Effective area [mm ²] ^{*2}	Weight [g]
a	b							
ø3.2	ø4	KQB2H23-04-F	9	25.6	12	12.6	3.4	6.8
ø4	ø6	KQB2H04-06-F	12	27.2	12.6	13.6	5.6	12.1
ø6	ø8	KQB2H06-08-F	14	30.7	13.6	16.1	13.1	17.1
ø8	ø10	KQB2H08-10-F	17	34.1	16.1	17	26.1	27.2
ø10	ø12	KQB2H10-12-F	19	36.6	17	18.6	41.5	34.8
ø12	ø16	KQB2H12-16-F	24.6	40.4	18.6	20.8	58.3	57.3

*1 For the ø16, this dimension refers to the O.D. of the release button.
*2 Value of FEP tubing

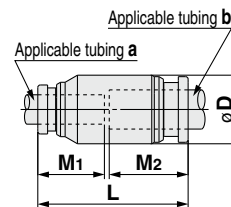

Different Diameter Union "Y": KQB2U



Applicable tubing O.D. [mm]		Model	øD ^{*1}	L ₁	L ₂	P	W	M ₁	M ₂	øN	øO	Effective area [mm ²] ^{*2}	Weight [g]
a	b												
ø3.2	ø4	KQB2U23-04-F	9.1	27	10.8	8.1	16.4	12	12.6	3.2	5.6	3.2	8.5
ø4	ø6	KQB2U04-06-F	11.4	29.3	11.2	9.1	18.2	12.6	13.6	3.2	5.6	4.2	11.9
ø6	ø8	KQB2U06-08-F	13.7	33.7	12.2	11.5	22.9	13.6	16.1	4.2	8	13.4	19.3
ø8	ø10	KQB2U08-10-F	16.6	38.3	13.8	14.6	28.3	16.1	17	4.2	8	25.6	32
ø10	ø12	KQB2U10-12-F	18.7	43	14	17.6	34.2	17	18.6	4.2	8	40	47.6
ø12	ø16	KQB2U12-16-F	24.6	47.4	15.6	19.8	38.5	18.6	20.8	4.2	8	57.4	67.6

*1 For the ø16, this dimension refers to the O.D. of the release button.
*2 Value of FEP tubing

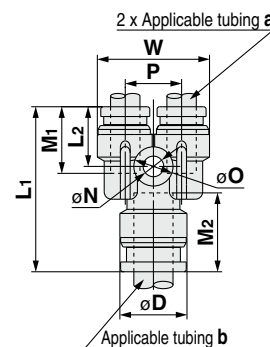

EHEDG Compliant

Metric M, G KFG2H□-E

Clean Design

Metric M, G KFG2H□-C

FDA Compliant

Metric M, R, Rc KQG2-F

Inch UNF, NPT KQG2-F

Metric G KQG2-F

Metric M, R, Rc KQB2-F

Inch UNF, NPT KQB2-F

Metric G KQB2-F

Metric R, Rc KQF2-F

Inch NPT KQF2-F

Metric G KQF2-F

Precautions

KQB2-F Series

Applicable Tubing: Metric Size, Connection Thread: M, R, Rc

Dimensions

Bulkhead Connector: KQB2E

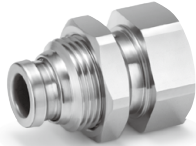

Applicable tubing O.D. [mm]	Connection thread Rc	Model	T (M)	Width across flats		L1	L2	Mounting hole	M	Effective area [mm ²] ^{*1}	Weight [g]
				H1	H2						
ø3.2	1/4	KQB2E23-02-F	M10 x 1	17	12	31	14.8	11	12	3.4	27.5
ø4	1/8	KQB2E04-01-F	M10 x 1	14	12	25.8	9.7	11	12.6	5.6	16.9
	1/4	KQB2E04-02-F		17	12	30.9	14.8				27.1
ø6	1/8	KQB2E06-01-F	M14 x 1	17	17	24.2	6.1	15	13.6	13.1	25
	1/4	KQB2E06-02-F		19	17	31.6	13.5				33.2
ø8	3/8	KQB2E06-03-F	M15 x 1	19	19	33	14.9	16	16.1	26.1	34.8
	1/8	KQB2E08-01-F		17	19	26.3	6.9				28.7
ø10	1/4	KQB2E08-02-F	M18 x 1	19	21	32.4	13	19	17	41.5	34.2
	3/8	KQB2E08-03-F		19	21	34	14.6				35.9
ø12	1/4	KQB2E10-02-F	M20 x 1	19	21	31.6	11.6	21	18.6	58.3	44
	3/8	KQB2E10-03-F		21	24	33.6	13.6				40.2
ø16	3/8	KQB2E12-03-F	M27 x 1	21	24	34	12.8	28	20.8	96	52
	1/2	KQB2E12-04-F		24	24	39.6	18.4				62.5
ø16	3/8	KQB2E16-03-F	M27 x 1	29	30	35.3	11.2	28	20.8	96	111
	1/2	KQB2E16-04-F		40.6	16.5	113	118.2				

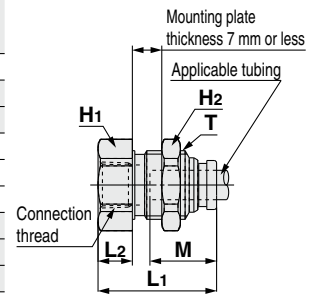

*1 Value of FEP tubing
Value of nylon tubing for ø16 only

Extended Male Elbow: KQB2W



Applicable tubing O.D. [mm]	Connection thread R, M	Model	H (Width across flats)	øD ^{*1}	ød	L1	L2	A ^{*2}	M	Effective area [mm ²] ^{*3}	Weight [g]
ø4	1/8	KQB2W23-01-F	10	—	13.6	31.3	33.6	15.3			
	1/4	KQB2W23-02-F	14	—	35.1	35.8	34.7				
ø6	M5 x 0.8	KQB2W04-M5-F	8	9.1	8	13.7	32.7	33.3	12.6	4	14.3
	1/8	KQB2W04-01-F	10		—	14.4	31.7	34.4			16.2
1/4	KQB2W04-02-F	14	—		35.5	36.6	35.6				
ø8	M5 x 0.8	KQB2W06-M5-F	8	11.4	8	14.7	33.8	35.5	13.6	10.9	16.2
	1/8	KQB2W06-01-F	10		—	15.9	32.8	36.7			17.8
1/4	KQB2W06-02-F	14	—		36.6	38.9	37.2				
ø10	3/8	KQB2W06-03-F	17	13.7	—	19.1	41.6	44.6	16.1	20.5	60.3
	1/8	KQB2W08-01-F	12		—	18.6	37	42			28.9
1/4	KQB2W08-02-F	14	—		40.2	43.6	43.6				
ø12	3/8	KQB2W08-03-F	17	16.6	—	21	46.6	51.5	17	33.5	39.2
	1/2	KQB2W10-02-F	14		—	21	45.9	50.4			42.1
3/8	KQB2W10-03-F	17	—		50.1	53.3	50.1				
ø16	1/2	KQB2W10-04-F	22	18.7	—	22.6	47.7	53.6	18.6	47.7	64.5
	3/8	KQB2W12-02-F	14		—	23.6	49	54.5			46
1/2	KQB2W12-03-F	17	—		53.2	57.4	53.2				
ø16	3/8	KQB2W12-04-F	22	24.6	—	26.3	57.6	65.4	20.8	71	118
	1/2	KQB2W16-03-F	19		—	27.3	61.4	67.9			89.6
1/2	KQB2W16-04-F	22	—		27.3	61.4	67.9	100			116

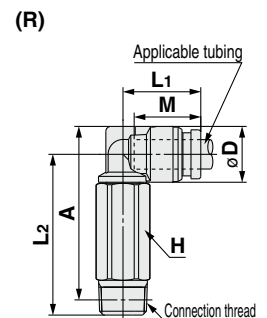
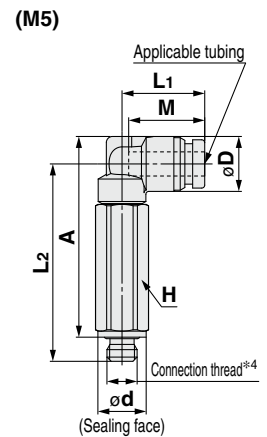

*1 For the ø16, this dimension refers to the O.D. of the release button.
*2 Reference dimensions after installation for R thread
*3 Value of FEP tubing
Value of nylon tubing for ø16 only
*4 In the case of M5, the screw length (øD/2 + L2 - A) is longer than that of the KQB2 series.

Metal One-touch Fittings **KQB2-F Series**

Applicable Tubing: Metric Size, Connection Thread: M, R, Rc

Dimensions

Female Connector: KQB2F



Applicable tubing O.D. [mm]	Connection thread Rc	Model	H (Width across flats)	øD *1	L1	L2	M	Effective area [mm ²] *2	Weight [g]
ø3.2	1/8	KQB2F23-01-F	12	8	23.3	9.8	12	3.4	9.3
ø4	1/8	KQB2F04-01-F	12	8.7	23.7	9.8	12.6	5.6	9.7
	1/4	KQB2F04-02-F	17		28.7	13.2			22.7
ø6	1/8	KQB2F06-01-F	12	11.1	24.2	10	13.6	13.1	11.1
	1/4	KQB2F06-02-F	17		29.2	13.4			24.3
	3/8	KQB2F06-03-F	19		30.6	14.2			25.8
ø8	1/8	KQB2F08-01-F	14	13.4	26.3	9.6	16.1	26.1	17.1
	1/4	KQB2F08-02-F	17		31.3	13.7			26.8
	3/8	KQB2F08-03-F	19		32.7	14.4			28.4
ø10	1/4	KQB2F10-02-F	17	16.4	31.6	13.9	17	41.5	30.3
	3/8	KQB2F10-03-F	19		33	14.7			32
ø12	1/4	KQB2F12-02-F	19	18.5	32.6	13.3	18.6	58.3	39.4
	3/8	KQB2F12-03-F	19		34	14.7			33.9
	1/2	KQB2F12-04-F	24		39.3	18.4			52.9
ø16	3/8	KQB2F16-03-F	24	24.6	35.3	13.5	20.8	81	62.8
	1/2	KQB2F16-04-F	24		40.6	18.8			113

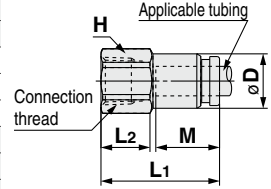

*1 For the ø10, ø12, and ø16, this dimension refers to the O.D. of the release button.
 *2 Value of FEP tubing
 Value of nylon tubing for ø16 only

Plug: KQB2P



Applicable fitting size ød	Model	øD	L	A	Weight [g]
ø3.2	KQB2P-23-F	5	28.9	16.9	2.8
ø4	KQB2P-04-F	6	29.6	17	4.3
ø6	KQB2P-06-F	8	30.8	17.2	9
ø8	KQB2P-08-F	10	33.7	17.6	16.3
ø10	KQB2P-10-F	12	34.6	17.6	25.4
ø12	KQB2P-12-F	14	36.5	17.9	37.8
ø16	KQB2P-16-F	18	38.6	17.8	69.2

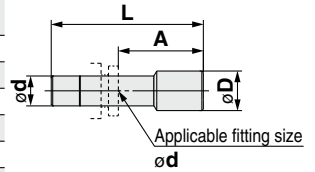

EHEDG Compliant

Metric M, G KFG2H-E

Clean Design

Metric M, G KFG2H-C

FDA Compliant

Metric M, R, Rc KQG2-F

Inch UNF, NPT KQG2-F

Metric G KQG2-F

Metric M, R, Rc KQB2-F

Inch UNF, NPT KQB2-F

Metric G KQB2-F

Metric R, Rc KFG2-F

Inch NPT KFG2-F

Metric G KFG2-F

Precautions

Metal One-touch Fittings

Applicable Tubing: Inch Size, Connection Thread: UNF, NPT

KQB2-F Series



Applicable Tubing

Tubing material*1	FEP, PFA, Nylon, Soft nylon, Polyurethane, Polyolefin
Tubing O.D.	ø1/8", ø5/32", ø1/4", ø5/16", ø3/8", ø1/2"

*1 Considering the product application, FDA-compliant products are recommended.

Specifications

Fluid	Air, Water*1
Operating pressure range*2	-100 kPa to 1 MPa*3
Proof pressure	3.0 MPa
Ambient and fluid temperatures*4	-5 to 150°C (No freezing)*3
Lubricant	NSF H1 grease
Seal on the threads	Without sealant

*1 Deionized water is not recommended for use as it may affect the material used in the fittings. In addition, it is known to degrade the water quality.

*2 Do not use the fittings with a leak tester or for vacuum retention because they are not guaranteed for zero leakage.

*3 Check the operating pressure range and operating temperature range of the tubing.

*4 It is recommended that you use the inner sleeve in the following conditions. (Except ø1/8")

- When using in an environment where the fluid temperature changes drastically
- When using at a high temperature

* Temperature Condition of Mounting the Inner Sleeve

Tubing	Temperature
FEP tubing/TH series	80°C or more
Super PFA tubing/TL series	120°C or more

Spare Parts

Description	Tubing O.D.	Part no.	Material
O-ring	—	M-5-F	FDA compliant FKM
Bulkhead nut	ø1/8" ø5/32"	KQB201-P01-F	C3604 (Electroless nickel plating)
	ø1/4"	KQB207-P01-F	
	ø5/16"	KQB209-P01-F	
	ø3/8"	KQB211-P01-F	
	ø1/2"	KQB213-P01-F	

Cross Reference Table of the Inner Sleeve

Tubing O.D.	Tubing material		Applicable inner sleeve	
	TH/TH (FEP)	TL/TIL (Super PFA)	Part no.	Length
ø5/32"	TH0402	—	TJG-0402	18
	TH0425	—	TJG-0425	18
	—	TL0403	TJG-0403	18
ø1/4"	TIHB07	TIL07	TJG-0604	19
	TIHA07	—	TJG-0746	19
ø5/16"	TH0806	TL0806	TJG-0806	20.5
ø3/8"	TIHB11	TIL11	TJG-1065	23
	TIHA11	—	TJG-1107	23
ø1/2"	TIH13	TIL13	TJG-1395	24

* Stainless steel 316 is used for the TJG series.

How to Order

KQB2 H 03 - N 03 - F

Body type

Symbol	Model
H	Male connector, Straight union, Different diameter straight
S	Hexagon socket head male connector
L	Male elbow, Union elbow
T	Male branch tee, Union tee, Different diameter tee
E	Bulkhead union, Bulkhead connector
U	Union "Y", Different diameter union "Y"
R	Plug-in reducer
W	Extended male elbow
F	Female connector
P	Plug

Tubing size (Inch)

Symbol	Size
01	ø 1/8"
03	ø 5/32"
07	ø 1/4"
09	ø 5/16"
11	ø 3/8"
13	ø 1/2"

FDA compliant

Thread size, Tubing size

Symbol	Size	
32	10-32UNF	Thread size
01	NPT1/8	
02	NPT1/4	
03	NPT3/8	
04	NPT1/2	Tubing size
00	Same tubing O.D.	
03	ø 5/32"	
07	ø 1/4"	
09	ø 5/16"	
11	ø 3/8"	
13	ø 1/2"	

* Sealant is unavailable for this product as no FDA-compliant material is available.

Thread type

Symbol	Type
N	NPT

Construction

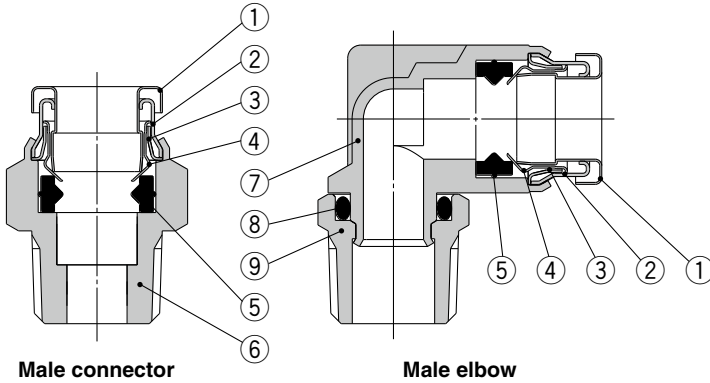

Component Parts

No.	Description	Material
1	Release button	Stainless steel 304
2	Guide 1	Stainless steel 304
3	Guide 2	Stainless steel 304
4	Chuck	Stainless steel 304
5	Seal	FDA compliant FKM (NSF H1 grease)
6	Male connector body	C3604 (Electroless nickel plating)
7	Male elbow body	Stainless steel 316
8	O-ring	FDA compliant FKM (NSF H1 grease)
9	Stud	C3604 (Electroless nickel plating)

EHEDG Compliant
Metric M, G
KFG2H□-E

Clean Design

Metric M, G
KFG2H□-C

FDA Compliant

Metric M, R, Rc
KQG2-F

Inch UNF, NPT
KQG2-F

Metric G
KQG2-F

Metric M, R, Rc
KQB2-F

Inch UNF, NPT
KQB2-F

Metric G
KQB2-F

Metric R, Rc
KFG2-F

Inch NPT
KFG2-F

Metric G
KFG2-F

Precautions

KQB2-F Series

Applicable Tubing: Inch Size, Connection Thread: UNF, NPT

Dimensions

Male Connector: KQB2H



Applicable tubing O.D. [inch]	Connection thread UNF, NPT	Model	H (Width across flats)	ød	L	A*1	M	Effective area [mm ²]*2	Weight [g]
ø1/8"	10-32UNF	KQB2H01-32-F	8	8	17.8	13.8	12	3	3.7
	1/8	KQB2H01-N01-F	11.11	—	17.1	15.2		3.4	7.9
	1/4	KQB2H01-N02-F	14.29	—	20.9	17.8		—	18
ø5/32"	10-32UNF	KQB2H03-32-F	10	8	18.4	14.4	12.6	4	7
	1/8	KQB2H03-N01-F	11.11	—	17	15.1		5.6	7.4
	1/4	KQB2H03-N02-F	14.29	—	20.9	17.8		—	17.5
ø1/4"	10-32UNF	KQB2H07-32-F	12	8	21	17	13.5	4	8.8
	1/8	KQB2H07-N01-F	12.7	—	20	18.1		13.1	9.8
	1/4	KQB2H07-N02-F	14.29	—	20.6	17.5			15.1
	3/8	KQB2H07-N03-F	17.46	—	23.8	20.4			31
ø5/16"	1/8	KQB2H09-N01-F	14.29	—	24.2	22.3	16.1		26.1
	1/4	KQB2H09-N02-F			23.1	20		14.9	
	3/8	KQB2H09-N03-F			24.6	21.2		28.3	
ø3/8"	1/8	KQB2H11-N01-F	17.46	—	25	23.1	16.6	26.1	21.5
	1/4	KQB2H11-N02-F			26.3	23.2			22.3
	3/8	KQB2H11-N03-F			23.6	20.2			41.5
	1/2	KQB2H11-N04-F			22.23	28.3			23.2
ø1/2"	1/4	KQB2H13-N02-F	22.23	—	30.5	27.4	18.5	58.3	39.4
	3/8	KQB2H13-N03-F			28.4	25			36.8
	1/2	KQB2H13-N04-F			—	23.3			46.1

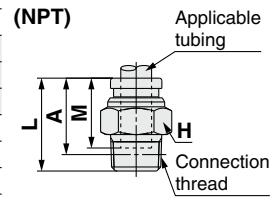
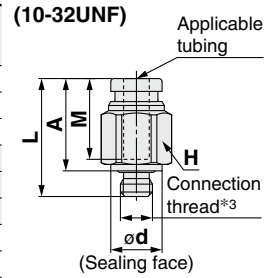

*1 Reference dimensions after installation for NPT thread

*2 Value of FEP tubing

*3 In the case of 10-32UNF, the screw length (L - A) is longer than that of the KQB2 series.

Hexagon Socket Head Male Connector: KQB2S



Applicable tubing O.D. [inch]	Connection thread UNF, NPT	Model	H (Width across flats)	øD	ød	L	A*1	M	Effective area [mm ²]*2	Weight [g]
ø1/8"	10-32UNF	KQB2S01-32-F	2	9	8	17.8	13.8	12	3	4.2
ø5/32"	10-32UNF	KQB2S03-32-F	2	9	8	18.4	14.4	12.6	4	4.2
	1/8	KQB2S03-N01-F	2.78	11	—	21.4	19.5		4.1	8.9
ø1/4"	10-32UNF	KQB2S07-32-F	2	12	8	20	16	13.5	4	7.3
	1/8	KQB2S07-N01-F	4.76		—	20.5	18.6		10	8.5
	1/4	KQB2S07-N02-F			14	—	17.4		14.1	
	3/8	KQB2S07-N03-F			18	—	21.5		18.1	10.7
ø5/16"	1/8	KQB2S09-N01-F		5.56	14	—	24.7	22.8	16.1	17.2
	1/4	KQB2S09-N02-F	6.35	23.1			20	23.3		13.4
	3/8	KQB2S09-N03-F	—	19.7			—	24.7		—
ø3/8"	1/8	KQB2S11-N01-F	5.56	17	—	25.2	23.3	16.6	17.2	18.7
	1/4	KQB2S11-N02-F	6.35			27.1	24		22.2	
	3/8	KQB2S11-N03-F				18	—		20.2	25
	1/2	KQB2S11-N04-F				22	—		18.5	40.6
ø1/2"	1/4	KQB2S13-N02-F		8	20	—	30.5	27.4	18.5	46
	3/8	KQB2S13-N03-F	9.53	29.4			26	30.4		
	1/2	KQB2S13-N04-F		22			—	20.4		36.5

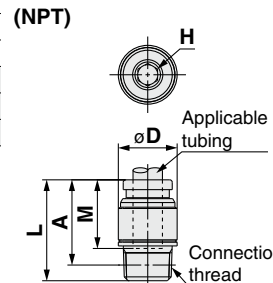
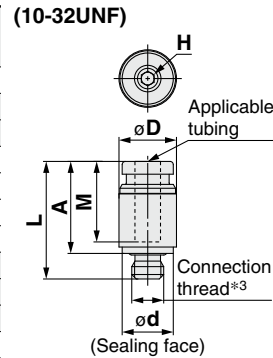

*1 Reference dimensions after installation for NPT thread

*2 Value of FEP tubing

*3 In the case of 10-32UNF, the screw length (L - A) is longer than that of the KQB2 series.

Straight Union: KQB2H



Applicable tubing O.D. [inch]	Model	øD	L	M	Effective area [mm ²]*1	Weight [g]
ø1/8"	KQB2H01-00-F	9	25	12	3.4	6.8
ø5/32"	KQB2H03-00-F	9	26.2	12.6	5.6	6.8
ø1/4"	KQB2H07-00-F	12	28	13.5	13.1	11.5
ø5/16"	KQB2H09-00-F	14	33.2	16.1	26.1	17.4
ø3/8"	KQB2H11-00-F	16	34.2	16.6	41.5	23.7
ø1/2"	KQB2H13-00-F	20	38	18.5	58.3	37

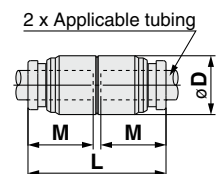

*1 Value of FEP tubing

Metal One-touch Fittings **KQB2-F Series**

Applicable Tubing: Inch Size, Connection Thread: UNF, NPT

Dimensions

Male Elbow: KQB2L



Applicable tubing O.D. [inch]	Connection thread UNF, NPT	Model	H (Width across flats)	øD	ød	L1	L2	A*1	M	Effective area [mm ²]*2	Weight [g]
ø1/8"	10-32UNF	KQB2L01-32-F	8	8.3	8	13.1	15.9	16.1	12	2.6	6.7
	1/8	KQB2L01-N01-F	11.11			13.6	14.9	17.1		3	8.8
	1/4	KQB2L01-N02-F	14.29			18.7	19.7	17.7			
ø5/32"	10-32UNF	KQB2L03-32-F	8	9.1	8	13.7	16.3	16.9	12.6	3.5	7.2
	1/8	KQB2L03-N01-F	11.11			14.4	15.3	17.9		4.2	9.7
	1/4	KQB2L03-N02-F	14.29			19.1	20.5	18.5			
ø1/4"	10-32UNF	KQB2L07-32-F	8	11.7	8	14.7	17.6	19.5	13.5	3.5	9.3
	1/8	KQB2L07-N01-F	11.11			15.9	16.6	20.5		11.4	11.4
	1/4	KQB2L07-N02-F	14.29			20.4	23.1	20.3		33.7	
ø5/16"	10-32UNF	KQB2L09-32-F	8	13.7	8	14.7	17.6	19.5	16.1	3.5	9.3
	1/8	KQB2L09-N01-F	11.11			15.9	16.6	20.5		21.6	15.8
	1/4	KQB2L09-N02-F	14.29			19.1	21.5	25.2		21.9	18.5
ø3/8"	10-32UNF	KQB2L11-32-F	8	16	8	14.7	17.6	19.5	16.6	3.5	9.3
	1/8	KQB2L11-N01-F	11.11			15.9	16.6	20.5		21.6	20.5
	1/4	KQB2L11-N02-F	14.29			20.4	23.1	23.9		35.2	35.8
ø1/2"	10-32UNF	KQB2L13-32-F	8	19.6	8	14.7	17.6	19.5	18.5	3.5	9.3
	1/8	KQB2L13-N01-F	11.11			15.9	16.6	20.5		50.2	30.1
	1/4	KQB2L13-N02-F	14.29			19.1	21.5	25.2		37.9	37.9

(10-32UNF)

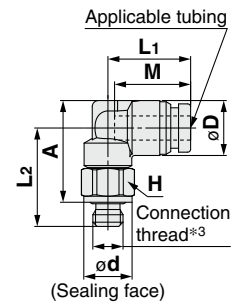

(NPT)

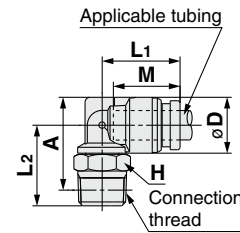

*1 Reference dimensions after installation for NPT thread
 *2 Value of FEP tubing
 *3 In the case of 10-32UNF, the screw length ($\phi D/2 + L2 - A$) is longer than that of the KQB2 series.

Male Branch Tee: KQB2T



Applicable tubing O.D. [inch]	Connection thread UNF, NPT	Model	H (Width across flats)	øD	ød	L1	L2	A*1	M	Effective area [mm ²]*2	Weight [g]
ø1/8"	10-32UNF	KQB2T01-32-F	8	8.3	8	13.1	15.9	16.1	12	3.2	8.4
	1/8	KQB2T01-N01-F	11.11			13.6	14.9	17.1		3.4	10.6
	1/4	KQB2T01-N02-F	14.29			18.7	19.7	19.5			
ø5/32"	10-32UNF	KQB2T03-32-F	8	9.1	8	13.7	16.3	16.9	12.6	4.5	9.3
	1/8	KQB2T03-N01-F	11.11			14.4	15.3	17.9		6	11.6
	1/4	KQB2T03-N02-F	14.29			19.1	20.5	20.5			
ø1/4"	10-32UNF	KQB2T07-32-F	8	11.7	8	14.7	17.6	19.5	13.5	4.5	12.5
	1/8	KQB2T07-N01-F	11.11			15.9	16.6	20.5		13.9	14.9
	1/4	KQB2T07-N02-F	14.29			20.4	23.1	23.8		37.1	
ø5/16"	10-32UNF	KQB2T09-32-F	8	13.7	8	14.7	17.6	19.5	16.1	4.5	12.5
	1/8	KQB2T09-N01-F	11.11			15.9	16.6	20.5		26.3	21.2
	1/4	KQB2T09-N02-F	14.29			19.1	21.5	25.2		27.1	20.5
ø3/8"	10-32UNF	KQB2T11-32-F	8	16	8	14.7	17.6	19.5	16.6	4.5	12.5
	1/8	KQB2T11-N01-F	11.11			15.9	16.6	20.5		40.8	28.1
	1/4	KQB2T11-N02-F	14.29			20.4	23.1	23.1		31.1	31.1
ø1/2"	10-32UNF	KQB2T13-32-F	8	19.6	8	14.7	17.6	19.5	18.5	4.5	12.5
	1/8	KQB2T13-N01-F	11.11			15.9	16.6	20.5		57.2	41.8
	1/4	KQB2T13-N02-F	14.29			19.1	21.5	25.2		49	49

(10-32UNF)

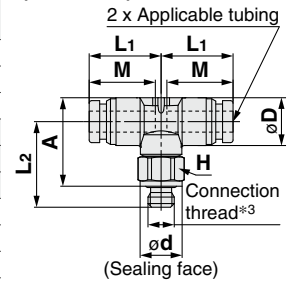

(NPT)

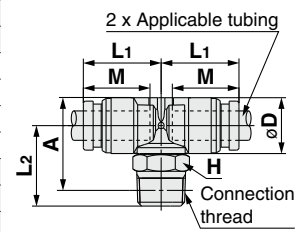

*1 Reference dimensions after installation for NPT thread
 *2 Value of FEP tubing
 *3 In the case of 10-32UNF, the screw length ($\phi D/2 + L2 - A$) is longer than that of the KQB2 series.

Union Elbow: KQB2L



Applicable tubing O.D. [inch]	Model	øD	L	A	Q	M	øN	øO	Effective area [mm ²]*1	Weight [g]
ø1/8"	KQB2L01-00-F	8.3	13.6	19.3	2.9	12	3.2	5.6	3	6.3
ø5/32"	KQB2L03-00-F	9.1	14.6	20.5	3.1	12.6	3.2	5.6	4.2	7.4
ø1/4"	KQB2L07-00-F	11.7	16.7	23.2	3.7	13.5	3.2	5.6	11.4	11.5
ø5/16"	KQB2L09-00-F	13.7	20.1	29.1	5	16.1	4.2	8	21.6	20.2
ø3/8"	KQB2L11-00-F	16	21.4	31.1	5.7	16.6	4.2	8	35.2	28.2
ø1/2"	KQB2L13-00-F	19.6	24.9	35.3	6.4	18.5	4.2	8	50.2	41.7

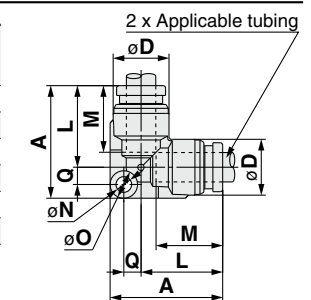

*1 Value of FEP tubing

KQB2-F Series

Applicable Tubing: Inch Size, Connection Thread: UNF, NPT

Dimensions

Bulkhead Union: KQB2E



Applicable tubing O.D. [inch]	Model	T (UNF)	H (Width across flats)	L	Mounting hole	M	Effective area [mm ²] ^{*1}	Weight [g]
ø1/8"	KQB2E01-00-F	7/16-20UNF	14.29	34.2	12.5	12	3.4	21.8
ø5/32"	KQB2E03-00-F	7/16-20UNF	14.29	34.4	12.5	12.6	5.6	21.6
ø1/4"	KQB2E07-00-F	1/2-20UNF	17.46	36.2	14	13.5	13.1	30.2
ø5/16"	KQB2E09-00-F	5/8-18UNF	22.23	41.2	17	16.1	26.1	43.9
ø3/8"	KQB2E11-00-F	3/4-16UNF	22.23	42.4	20.5	16.6	41.5	64.2
ø1/2"	KQB2E13-00-F	7/8-14UNF	25.4	47	23.5	18.5	58.3	94.2

*1 Value of FEP tubing

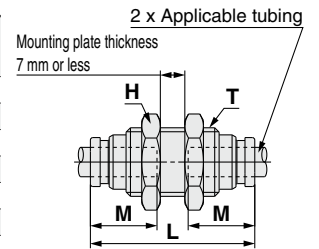

Union Tee: KQB2T



Applicable tubing O.D. [inch]	Model	øD	L	A	Q	M	øN	øO	Effective area [mm ²] ^{*1}	Weight [g]
ø1/8"	KQB2T01-00-F	8.3	13.6	20.5	4.1	12	3.2	5.6	3.4	7.9
ø5/32"	KQB2T03-00-F	9.1	14.6	21.8	4.4	12.6	3.2	5.6	6.4	9.5
ø1/4"	KQB2T07-00-F	11.7	16.7	24.7	5.2	13.5	3.2	5.6	13.4	14.7
ø5/16"	KQB2T09-00-F	13.7	20.1	31.1	7	16.1	4.2	8	25.6	24.4
ø3/8"	KQB2T11-00-F	16	21.4	33.4	8	16.6	4.2	8	40	34.7
ø1/2"	KQB2T13-00-F	19.6	24.9	37.9	9	18.5	4.2	8	57.4	52.3

*1 Value of FEP tubing

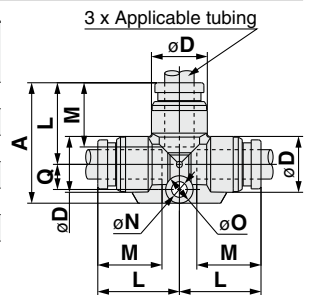

Union "Y": KQB2U



Applicable tubing O.D. [inch]	Model	øD	W	L1	L2	P	M	øN	øO	Effective area [mm ²] ^{*1}	Weight [g]
ø1/8"	KQB2U01-00-F	8.3	16.4	29	11	8.1	12	3.2	5.6	3.4	9.2
ø5/32"	KQB2U03-00-F	9.1	18.2	30.4	11.3	9.1	12.6	3.2	5.6	4.2	11.1
ø1/4"	KQB2U07-00-F	11.7	23.9	34.5	12.1	12.2	13.5	3.2	5.6	13.4	19.6
ø5/16"	KQB2U09-00-F	13.7	28.3	40.1	14.1	14.6	16.1	4.2	8	25.6	29.7
ø3/8"	KQB2U11-00-F	16	33.2	42.2	14	17.2	16.6	4.2	8	40	43.1
ø1/2"	KQB2U13-00-F	19.6	40.2	47.3	15.8	20.6	18.5	4.2	8	57.4	66.4

*1 Value of FEP tubing

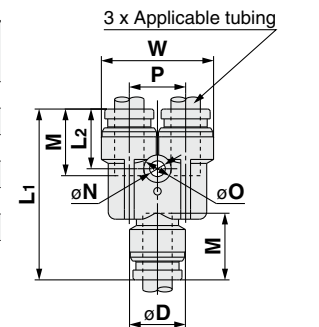

Different Diameter Tee: KQB2T



Applicable tubing O.D. [inch]	Model	øD1	øD2	L1	L2	L3	Q	M1	M2	øN	øO	Effective area [mm ²] ^{*1}	Weight [g]
ø1/8" ø5/32"	KQB2T01-03-F	9.1	8.3	14.2	14.1	21.1	4.1	12.6	12	3.2	5.6	3.8	8.5
ø5/32" ø1/4"	KQB2T03-07-F	11.7	9.1	15.5	15.9	22.7	4.4	13.5	12.6	3.2	5.6	7.1	11.7
ø1/4" ø5/16"	KQB2T07-09-F	13.7	11.7	19.3	17.6	29.6	6.3	16.1	13.5	4.2	8	16.4	20.2
ø5/16" ø3/8"	KQB2T09-11-F	16	13.7	20.6	21	31.7	7.1	16.6	16.1	4.2	8	36	28.9
ø3/8" ø1/2"	KQB2T11-13-F	19.6	16	23.3	23	35.4	8.1	18.5	16.6	4.2	8	56	41.8

*1 Value of FEP tubing

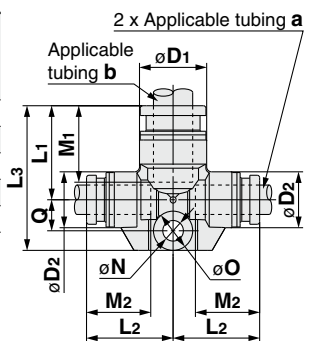

Plug-in Reducer: KQB2R



Applicable tubing O.D. [inch]	Applicable fitting size ød	Model	øD	L	A	M	Effective area [mm ²] ^{*1}	Weight [g]
ø1/8"	ø5/32"	KQB2R01-03-F	9	32.9	20.3	12	3.4	4.9
ø5/32"	ø1/4"	KQB2R03-07-F	9	33.7	20.2	12.6	5.6	7.4
ø1/4"	ø5/16"	KQB2R07-09-F	12	38.4	22.3	13.5	13.1	12.5
ø5/16"	ø3/8"	KQB2R09-11-F	14	41.6	25	16.1	26.1	17.7
ø3/8"	ø1/2"	KQB2R11-13-F	17	39.8	21.3	16.6	41.5	24.7

*1 Value of FEP tubing

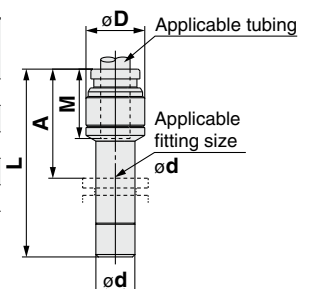

Metal One-touch Fittings **KQB2-F Series**

Applicable Tubing: Inch Size, Connection Thread: UNF, NPT

Dimensions

Different Diameter Straight: KQB2H



Applicable tubing O.D. [inch]		Model	øD	L	M1	M2	Effective area [mm ²] ^{*1}	Weight [g]
a	b							
ø1/8"	ø5/32"	KQB2H01-03-F	9	25.6	12	12.6	3.4	6.8
ø5/32"	ø1/4"	KQB2H03-07-F	12	27.1	12.6	13.5	5.6	11.9
ø1/4"	ø5/16"	KQB2H07-09-F	14	30.6	13.5	16.1	13.1	16.8
ø5/16"	ø3/8"	KQB2H09-11-F	16	33.7	16.1	16.6	26.1	23.9
ø3/8"	ø1/2"	KQB2H11-13-F	20	36.1	16.6	18.5	41.5	38.8

*1 Value of FEP tubing

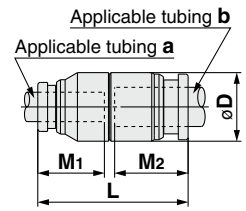

Different Diameter Union "Y": KQB2U



Applicable tubing O.D. [inch]		Model	øD	L1	L2	P	W	M1	M2	øN	øO	Effective area [mm ²] ^{*1}	Weight [g]
a	b												
ø1/8"	ø5/32"	KQB2U01-03-F	9.1	27	10.8	8.1	16.4	12	12.6	3.2	5.6	3.2	8.5
ø5/32"	ø1/4"	KQB2U03-07-F	11.7	28.8	11.4	9.1	18.2	12.6	13.5	3.2	5.6	4.2	11.8
ø1/4"	ø5/16"	KQB2U07-09-F	13.7	33.8	12	12.2	23.9	13.5	16.1	4.2	8	13.4	20
ø5/16"	ø3/8"	KQB2U09-11-F	16	38.3	13.8	14.6	28.3	16.1	16.6	4.2	8	25.6	31
ø3/8"	ø1/2"	KQB2U11-13-F	19.6	40.5	13.7	17.2	33.2	16.6	18.5	4.2	8	40	45

*1 Value of FEP tubing

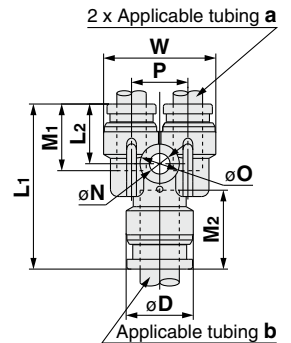

Bulkhead Connector: KQB2E

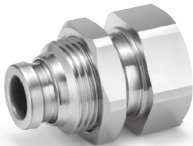

Applicable tubing O.D. [inch]	Connection thread NPT	Model	T (UNF)	Width across flats		L1	L2	Mounting hole	M	Effective area [mm ²] ^{*1}	Weight [g]
				H1	H2						
ø1/8"	1/4	KQB2E01-N02-F	7/16-20UNF	17.46	14.29	32.8	15.3	12.5	12	3.4	34.1
ø5/32"	1/4	KQB2E03-N02-F	7/16-20UNF	17.46	14.29	32.6	15.3	12.5	12.6	5.6	33.5
ø1/4"	1/4	KQB2E07-N02-F	1/2-20UNF	17.46	17.46	33.1	14.8	14	13.5	13.1	36.5
ø5/16"	3/8	KQB2E09-N03-F	5/8-18UNF	22.23	22.23	35.8	15.1	17	16.1	26.1	56.1
ø3/8"	3/8	KQB2E11-N03-F	3/4-16UNF	22.23	22.23	35.2	13.7	20.5	16.6	41.5	62.9
ø1/2"	3/8	KQB2E13-N03-F	7/8-14UNF	23.81	25.4	34.6	11	23.5	18.5	58.3	76.6
	1/2	KQB2E13-N04-F				42.2	18.6				80.2

*1 Value of FEP tubing

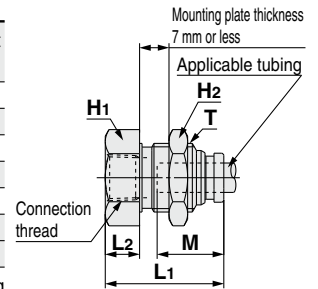

Extended Male Elbow: KQB2W



Applicable tubing O.D. [inch]	Connection thread NPT	Model	H (Width across flats)	øD	L1	L2	A ^{*1}	M	Effective area [mm ²] ^{*2}	Weight [g]	
											ø1/8"
	1/4	KQB2W01-N02-F	14.29	35.4	36.4	37.3					
ø5/32"	1/8	KQB2W03-N01-F	11.11	9.1	14.4	32	34.6	12.6	4	20.3	
		1/4	KQB2W03-N02-F			14.29	35.8			37.2	38.2
ø1/4"	1/8	KQB2W07-N01-F	11.11	11.7	15.9	33.3	37.2	13.5	10.9	22.1	
		1/4	KQB2W07-N02-F			14.29	37.1			39.8	39.9
		3/8	KQB2W07-N03-F			17.46	38.9			41.3	65.6
ø5/16"	1/8	KQB2W09-N01-F	12.7	13.7	19.1	18.6	34.7	16.1	20.5	30.4	
		1/4	KQB2W09-N02-F			14.29	40.2			43.9	41.6
		3/8	KQB2W09-N03-F			17.46	42			45.4	68.5
ø3/8"	1/4	KQB2W11-N02-F	14.29	16	21	47.2	52.1	16.6	33.5	44.9	
		3/8	KQB2W11-N03-F			17.46	45.4			50	67.8
		1/2	KQB2W11-N04-F			22.23	49.2			52.1	124.2
ø1/2"	1/4	KQB2W13-N02-F	14.29	19.6	23.7	22.7	49	18.5	47.7	51.1	
		3/8	KQB2W13-N03-F			17.46	50.7			57.1	66
		1/2	KQB2W13-N04-F			22.23	54.5			59.2	125.9

*1 Reference dimensions after installation of NPT thread

*2 Value of FEP tubing

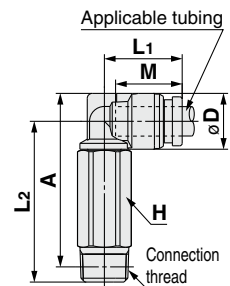

EHEDG
Compliant

Metric M, G
KFG2H□-E

Clean
Design

Metric M, G
KFG2H□-C

FDA
Compliant

Metric M, R, Rc
KQG2-F

Inch UNF, NPT
KQG2-F

Metric G
KQG2-F

Metric M, R, Rc
KQB2-F

Inch UNF, NPT
KQB2-F

Metric G
KQB2-F

Metric R, Rc
KFG2-F

Inch NPT
KFG2-F

Metric G
KFG2-F

Precautions

KQB2-F Series

Applicable Tubing: Inch Size, Connection Thread: UNF, NPT

Dimensions

Female Connector: KQB2F



Applicable tubing O.D. [inch]	Connection thread NPT	Model	H (Width across flats)	øD*1	L1	L2	M	Effective area [mm ²]*2	Weight [g]
ø1/8"	1/8	KQB2F01-N01-F	12.7	8	24.1	10.4	12	3.4	11.3
	1/4	KQB2F01-N02-F	17.46		29.1	13.7			25.4
ø5/32"	1/8	KQB2F03-N01-F	12.7	8.7	24.6	10.5	12.6	5.6	11.8
	1/4	KQB2F03-N02-F	17.46		29.6	13.8			25.9
ø1/4"	1/8	KQB2F07-N01-F	12.7	11.2	25	10.7	13.5	13.1	13
	1/4	KQB2F07-N02-F	17.46		30	14.1			27.5
	3/8	KQB2F07-N03-F	22.23		31.2	14.6			41.1
ø5/16"	1/8	KQB2F09-N01-F	14.29	13.4	27.2	10.3	16.1	26.1	18.8
	1/4	KQB2F09-N02-F	17.46		32.2	14.3			30.1
	3/8	KQB2F09-N03-F	22.23		33.4	14.8			44
ø3/8"	1/4	KQB2F11-N02-F	17.46	16	32.1	14.4	16.6	41.5	32.9
	3/8	KQB2F11-N03-F	22.23		33.3	14.9			47
	1/2	KQB2F11-N04-F	23.81		38.6	18.6			50.4
ø1/2"	3/8	KQB2F13-N03-F	22.23	19.3	34.6	14.7	18.5	58.3	51.3
	1/2	KQB2F13-N04-F	23.81		39.9	18.8			55.1

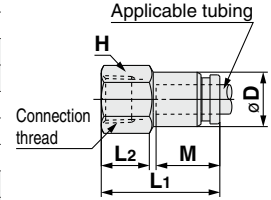

*1 For the ø3/8", this dimension refers to the O.D. of the release button.
*2 Value of FEP tubing

Plug: KQB2P



Applicable fitting size ød	Model	øD	L	A	Weight [g]
ø1/8"	KQB2P-01-F	5	28.9	16.9	2.8
ø5/32"	KQB2P-03-F	6	29.6	17	4.3
ø1/4"	KQB2P-07-F	8	30.3	16.8	9.4
ø5/16"	KQB2P-09-F	10	33.7	17.6	16.3
ø3/8"	KQB2P-11-F	11	34.1	17.5	22.2
ø1/2"	KQB2P-13-F	14	36.4	17.9	40.7

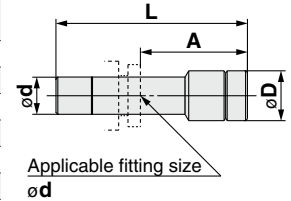

Metal One-touch Fittings

Applicable Tubing: Metric Size, Connection Thread: G*1

KQB2-F Series

*1 ISO 16030 compliant



Applicable Tubing

Tubing material*1	FEP, PFA, Nylon, Soft nylon, Polyurethane, Polyolefin
Tubing O.D.	ø4, ø6, ø8, ø10, ø12, ø16

*1 Considering the product application, FDA-compliant products are recommended.

Specifications

Fluid	Air, Water*1
Operating pressure range*2	-100 kPa to 1 MPa*3
Proof pressure	3.0 MPa
Ambient and fluid temperatures*4	-5 to 150°C (No freezing)*3
Lubricant	NSF H1 grease
Seal on the threads	O-ring seal

*1 Deionized water is not recommended for use as it may affect the material used in the fittings. In addition, it is known to degrade the water quality.

*2 Do not use the fittings with a leak tester or for vacuum retention because they are not guaranteed for zero leakage.

*3 Check the operating pressure range and operating temperature range of the tubing.

*4 It is recommended that you use the inner sleeve in the following conditions.
 · When using in an environment where the fluid temperature changes drastically
 · When using at a high temperature

* Temperature Condition of Mounting the Inner Sleeve

Tubing	Temperature
FEP tubing/TH series	80°C or more
Super PFA tubing/TL series	120°C or more

Spare Parts

Description	Tubing O.D.	Part no.	Material
Bulkhead nut	ø4	KQB223-P01-F	C3604 (Electroless nickel plating)
	ø6	KQB206-P01-F	
	ø8	KQB208-P01-F	
	ø10	KQB210-P01-F	
	ø12	KQB212-P01-F	
	ø16	KQB216-P01-F	

Description	Thread size	Part no.	Material
G thread O-ring	G1/8	KQB2-G01-F	FDA compliant FKM
	G1/4	KQB2-G02-F	
	G3/8	KQB2-G03-F	
	G1/2	KQB2-G04-F	

Cross Reference Table of the Inner Sleeve

Tubing O.D.	Tubing material			Applicable inner sleeve	
	TUS (Soft polyurethane)	TH/TH (FEP)	TL/TIL (Super PFA)	Part no.	Length
ø4	—	TH0402	—	TJG-0402	18
	TUS0425	TH0425	—	TJG-0425	18
	—	—	TL0403	TJG-0403	18
ø6	TUS0604	TH0604	TL0604	TJG-0604	19
	TUS0805	—	—	TJG-0805	20.5
ø8	—	TH0806	TL0806	TJG-0806	20.5
	TUS1065	—	—	TJG-1065	23
ø10	—	TH1075	—	TJG-1075	23
	—	TH1008	TL1008	TJG-1008	23
	TUS1208	—	—	TJG-1008	24
ø12	—	TH1209	—	TJG-1209	24
	—	TH1210	TL1210	TJG-1210	24

* Stainless steel 316 is used for the TJG series.

EHDG Compliant
 Metric M, G KFG2H□-E
 Clean Design
 Metric M, G KFG2H□-C
 FDA Compliant
 Metric M, R, Rc KQG2-F
 Inch UNF, NPT KQG2-F
 Metric G KQG2-F
 Metric M, R, Rc KQB2-F
 Inch UNF, NPT KQB2-F
 Metric G KQB2-F
 Metric R, Rc KFG2-F
 Inch NPT KFG2-F
 Metric G KFG2-F
 Precautions

KQB2-F Series

Applicable Tubing: Metric Size, Connection Thread: G

How to Order

KQB2 H 04 - G 02 - F

• Body type

Symbol	Model
H	Male connector
S	Hexagon socket head male connector
L	Male elbow
T	Male branch tee
E	Bulkhead connector
W	Extended male elbow
F	Female connector

• FDA compliant

• Thread size

Symbol	Size
01	G1/8
02	G1/4
03	G3/8
04	G1/2

• Tubing size (Metric)

Symbol	Size
23	ø3.2
04	ø4
06	ø6
08	ø8
10	ø10
12	ø12
16	ø16

• Thread type

Symbol	Type
G	G

Construction

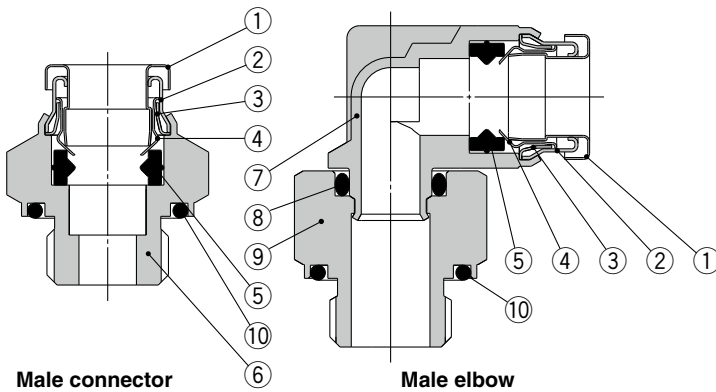

Component Parts

No.	Description	Material
1	Release button	Stainless steel 304
2	Guide 1	Stainless steel 304
3	Guide 2	Stainless steel 304
4	Chuck	Stainless steel 304
5	Seal	FDA compliant FKM (NSF H1 grease)
6	Male connector body	C3604 (Electroless nickel plating)
7	Male elbow body	Stainless steel 316
8	O-ring	FDA compliant FKM (NSF H1 grease)
9	Stud	C3604 (Electroless nickel plating)
10	G thread O-ring	FDA compliant FKM

Metal One-touch Fittings **KQB2-F Series**

Applicable Tubing: Metric Size, Connection Thread: G

Dimensions

Male Connector: KQB2H



Applicable tubing O.D. (mm)	Connection thread G	Model	H (Width across flats)	øD	ød	L	A	M	Effective area [mm ²] ^{*1}	Weight [g]
ø4	1/8	KQB2H04-G01-F	14	—	13.8	16.6	11.1	12.6	5.6	9.2
	1/4	KQB2H04-G02-F	19		17.8	20.6	14.1			23.6
ø6	1/8	KQB2H06-G01-F	14	—	13.8	17.6	12.1	13.6	13.1	8.9
	1/4	KQB2H06-G02-F	19		17.8	20.5	14			21.6
ø6	3/8	KQB2H06-G03-F	22	—	21.8	23.4	15.9	16.1	26.1	38.3
	1/8	KQB2H08-G01-F	14		13.8	23.9	18.4			13.2
ø8	1/4	KQB2H08-G02-F	19	—	17.8	21.2	14.7	17	41.5	19.1
	3/8	KQB2H08-G03-F	22		21.8	24	16.5			35.2
ø10	1/8	KQB2H10-G01-F	17	—	13.8	25.1	19.6	18.6	58.3	19.9
	1/4	KQB2H10-G02-F	19		17.8	24.9	18.4			24.8
	3/8	KQB2H10-G03-F	22		21.8	23.3	15.8			30.9
ø10	1/2	KQB2H10-G04-F	27	—	26.5	27.7	18.7	20.8	81	64.4
	1/4	KQB2H12-G02-F	19		17.8	27.7	21.2			26.3
	3/8	KQB2H12-G03-F	22		21.8	23.5	16			25.5
ø12	1/2	KQB2H12-G04-F	27	—	26.5	27.9	18.9	20.8	113	58
	3/8	KQB2H16-G03-F	24		24.6	21.8	31.3			23.8
ø16	1/2	KQB2H16-G04-F	27	26.5		27.3	18.3	43		

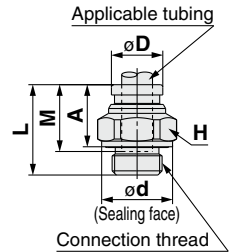

*1 Value of FEP tubing
Value of nylon tubing for ø16 only

Hexagon Socket Head Male Connector: KQB2S



Applicable tubing O.D. (mm)	Connection thread G	Model	H (Width across flats)	øD	ød	L	A	M	Effective area [mm ²] ^{*1}	Weight [g]
ø4	1/8	KQB2S04-G01-F	3	14	14	20.4	14.9	12.6	4.1	13.5
ø6	1/8	KQB2S06-G01-F	4	14	14	20.6	15.1	13.6	10	12.1
	1/4	KQB2S06-G02-F		18	18		14.1		10.7	19.9
ø8	1/8	KQB2S08-G01-F	5	14	14	23.9	18.4	16.1	17.2	12.5
	1/4	KQB2S08-G02-F	6	18	18	22.9	16.4		20.1	
ø8	3/8	KQB2S08-G03-F		22	22	23.1	15.6	17	23.3	31.1
	1/8	KQB2S10-G01-F	5	17	14	25.1	19.6			17.2
ø10	1/4	KQB2S10-G02-F	8	18	18	24.9	18.4	18.6	46	20.4
	3/8	KQB2S10-G03-F		22	22	24	16.5			31.2
ø10	1/2	KQB2S10-G04-F	27	26.5	24	15	45.3			
	1/4	KQB2S12-G02-F	8	19	18	27.7	21.2	18.6	60	23.6
ø12	3/8	KQB2S12-G03-F	10	22	22	24.9	17.4			27.4
	1/2	KQB2S12-G04-F		27	26.5		15.9	42.6		
ø16	3/8	KQB2S16-G03-F	10	24.6	22	31.3	23.8	20.8	113	41
	1/2	KQB2S16-G04-F	12	27	26.5	27.8	18.8			42.9

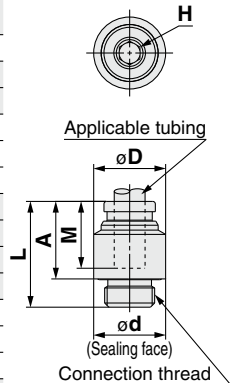

*1 Value of FEP tubing
Value of nylon tubing for ø16 only

EHDG Compliant

Metric M, G
KFG2H□-E

Clean Design

Metric M, G
KFG2H□-C

FDA Compliant

Metric M, R, Rc
KQG2-F

Inch UNF, NPT
KQG2-F

Metric G
KQG2-F

Metric M, R, Rc
KQB2-F

Inch UNF, NPT
KQB2-F

Metric G
KQB2-F

Metric R, Rc
KFG2-F

Inch NPT
KFG2-F

Metric G
KFG2-F

Precautions

KQB2-F Series

Applicable Tubing: Metric Size, Connection Thread: G

Dimensions

Male Elbow: KQB2L



Applicable tubing O.D. [mm]	Connection thread G	Model	H (Width across flats)	øD*1	ød	L1	L2	A	M	Effective area [mm ²]*2	Weight [g]	
ø4	1/8	KQB2L04-G01-F	14	9.1	13.8	14.4	18.9	17.9	12.6	4.2	15.6	
	1/4	KQB2L04-G02-F	19		17.8		22.3	20.3			33	
ø6	1/8	KQB2L06-G01-F	14	11.4	13.8	15.9	20	20.2	13.6	11.4	17.2	
	1/4	KQB2L06-G02-F	19		17.8		23.4	22.6			34.6	
	3/8	KQB2L06-G03-F	22		21.8		25.9	24.1			54.5	
ø8	1/8	KQB2L08-G01-F	14	13.7	13.8	18.6	21.3	22.6	16.1	21.6	20.2	
	1/4	KQB2L08-G02-F	19		17.8		24.7	25			36	
	3/8	KQB2L08-G03-F	22		21.8		27.2	26.5			55.6	
ø10	1/8	KQB2L10-G01-F	14	16.6	13.8	20	22.7	25.5	17	21.6	25.7	
	1/4	KQB2L10-G02-F	19		17.8		26.1	27.9			38.2	
	3/8	KQB2L10-G03-F	22		21.8		21	28.6		29.4	56.2	
	1/2	KQB2L10-G04-F	27		26.5		32.6	31.9		97.9		
ø12	1/4	KQB2L12-G02-F	19	18.7	17.8	22.6	27.2	30	18.6	50.2	41.9	
	3/8	KQB2L12-G03-F	22		21.8		23.6	29.6			31.4	54.3
	1/2	KQB2L12-G04-F	27		26.5		33.6	33.9			94.6	
ø16	3/8	KQB2L16-G03-F	22	24.6	21.8	26.3	32.4	36.5	20.8	71	64.7	
	1/2	KQB2L16-G04-F	27		26.5		27.3	36.4			39	100

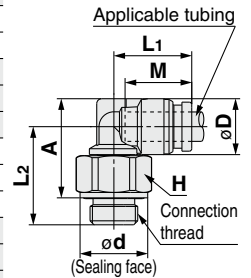

*1 For the ø16, this dimension refers to the O.D. of the release button.

*2 Value of FEP tubing
Value of nylon tubing for ø16 only

Male Branch Tee: KQB2T



Applicable tubing O.D. [mm]	Connection thread G	Model	H (Width across flats)	øD*1	ød	L1	L2	A	M	Effective area [mm ²]*2	Weight [g]	
ø4	1/8	KQB2T04-G01-F	14	9.1	13.8	14.4	18.9	17.9	12.6	6	17.5	
	1/4	KQB2T04-G02-F	19		17.8		22.3	20.3			34.9	
ø6	1/8	KQB2T06-G01-F	14	11.4	13.8	15.9	20	20.2	13.6	13.9	21	
	1/4	KQB2T06-G02-F	19		17.8		23.4	22.6			38	
	3/8	KQB2T06-G03-F	22		21.8		25.9	24.1			57.9	
ø8	1/8	KQB2T08-G01-F	14	13.7	13.8	18.6	21.3	22.6	16.1	26.3	25.6	
	1/4	KQB2T08-G02-F	19		17.8		24.7	25			41.2	
	3/8	KQB2T08-G03-F	22		21.8		27.2	26.5			60.8	
ø10	1/8	KQB2T10-G01-F	14	16.6	13.8	20	22.7	25.5	17	40.8	34	
	1/4	KQB2T10-G02-F	19		17.8		26.1	27.9			46	
	3/8	KQB2T10-G03-F	22		21.8		21	28.6		29.4	64	
	1/2	KQB2T10-G04-F	27		26.5		32.6	31.9		105.8		
ø12	1/4	KQB2T12-G02-F	19	18.7	17.8	22.6	27.2	30	18.6	57.2	53	
	3/8	KQB2T12-G03-F	22		21.8		23.6	29.6			31.4	54.3
	1/2	KQB2T12-G04-F	27		26.5		33.6	33.9			105	
ø16	3/8	KQB2T16-G03-F	22	24.6	21.8	26.3	32.4	36.5	20.8	71	82.2	
	1/2	KQB2T16-G04-F	27		26.5		27.3	36.4			39	100

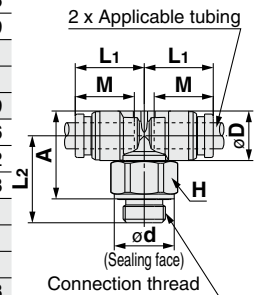

*1 For the ø16, this dimension refers to the O.D. of the release button.

*2 Value of FEP tubing
Value of nylon tubing for ø16 only

Metal One-touch Fittings **KQB2-F Series**

Applicable Tubing: Metric Size, Connection Thread: G

Dimensions

Bulkhead Connector: KQB2E



Applicable tubing O.D. [mm]	Connection thread G	Model	T (M)	Width across flats		L1	L2	Mounting hole	M	Effective area ^{*1} [mm ²]	Weight [g]
				H1	H2						
ø4	1/8	KQB2E04-G01-F	M10 x 1	17	12	27.1	11	11	12.6	5.6	25.1
	1/4	KQB2E04-G02-F		19	17	32.7	16.6				36.9
ø6	1/8	KQB2E06-G01-F	M14 x 1	17	17	25.5	7.4	15	13.6	13.1	26.8
	3/8	KQB2E06-G03-F		24	17	35	16.9				62
ø8	1/8	KQB2E08-G01-F	M15 x 1	17	19	27.6	8.2	16	16.1	26.1	30.4
	1/4	KQB2E08-G02-F		19	19	34.5	15.1				43.9
	3/8	KQB2E08-G03-F		24	19	36	16.6				66.2
ø10	1/4	KQB2E10-G02-F	M18 x 1	19	21	33.5	13.5	19	17	41.5	46.8
	3/8	KQB2E10-G03-F		24	21	35.6	15.6				65.4
ø12	3/8	KQB2E12-G03-F	M20 x 1	24	24	35.9	14.7	21	18.6	58.3	119.2
	1/2	KQB2E12-G04-F		27	24	42.2	21				91.9
ø16	3/8	KQB2E16-G03-F	M27 x 1	29	30	37.2	13.1	28	20.8	96	118.2
	1/2	KQB2E16-G04-F		43.1	19	113	128.7				

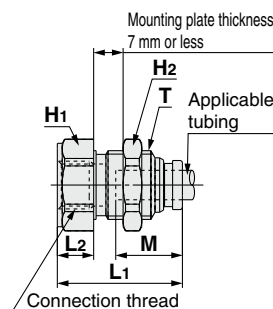

*1 Value of FEP tubing
Value of nylon tubing for ø16 only

Extended Male Elbow: KQB2W



Applicable tubing O.D. [mm]	Connection thread G	Model	H (Width across flats)	øD ^{*1}	ød	L1	L2	A	M	Effective area ^{*2} [mm ²]	Weight [g]
	1/4	KQB2W04-G02-F	19	17.8	38.7	36.7	70.6				
ø6	1/8	KQB2W06-G01-F	14	11.4	13.8	15.9	36.4	36.6	13.6	10.9	36.1
	1/4	KQB2W06-G02-F	19		17.8	39.8	39	72.2			
ø8	3/8	KQB2W06-G03-F	22	21.8	42.3	40.5	106.7				
	1/8	KQB2W08-G01-F	14	13.7	13.8	18.6	40	41.3	16.1	20.5	41.3
	1/4	KQB2W08-G02-F	19		17.8	19.1	43.4	43.7			76.7
3/8	KQB2W08-G03-F	22	21.8		45.9	45.2	112.9				
ø10	1/4	KQB2W10-G02-F	19	16.6	17.8	21	49.8	51.6	17	33.5	84.8
	3/8	KQB2W10-G03-F	22		21.8	50.2	51	116.6			
	1/2	KQB2W10-G04-F	27		26.5	54.2	53.5	196.6			
ø12	1/4	KQB2W12-G02-F	19	18.7	17.8	22.6	50.9	53.7	18.6	47.7	88.7
	3/8	KQB2W12-G03-F	22		21.8	53.3	55.1	111.6			
ø16	1/2	KQB2W12-G04-F	27	26.5	57.3	57.6	193.8				
	3/8	KQB2W16-G03-F	22	24.6	21.8	26.3	62	66.1	20.8	71	133.6
1/2	KQB2W16-G04-F	27	26.5		27.3	66	68.6	100			201.6

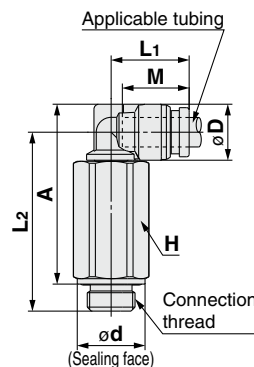

*1 For the ø16, this dimension refers to the O.D. of the release button.
*2 Value of FEP tubing
Value of nylon tubing for ø16 only

Female Connector: KQB2F



Applicable tubing O.D. [mm]	Connection thread G	Model	H1 (Width across flats)	øD ^{*1}	L1	L2	M	Effective area ^{*2} [mm ²]	Weight [g]
	1/4	KQB2F04-G02-F	19	30.6	14.5	32			
ø6	1/8	KQB2F06-G01-F	17	11.1	25.5	9.7	13.6	13.1	22.6
	1/4	KQB2F06-G02-F	19		31.1	14.7			33
ø8	3/8	KQB2F06-G03-F	24	32.6	14.6	51.1			
	1/8	KQB2F08-G01-F	17	13.4	27.6	10	16.1	26.1	25.1
	1/4	KQB2F08-G02-F	19		33.2	14.9			36.3
3/8	KQB2F08-G03-F	24	34.6		14.7	53.8			
ø10	1/4	KQB2F10-G02-F	19	16.4	33.5	15.2	17	41.5	39.9
	3/8	KQB2F10-G03-F	24		34.9	15			57.7
ø12	1/4	KQB2F12-G02-F	19	18.5	34.5	15.2	18.6	58.3	41.8
	3/8	KQB2F12-G03-F	24		35.9	15			59.7
ø16	1/2	KQB2F12-G04-F	27	24.6	41.8	19.9	20.8	81	81.6
	3/8	KQB2F16-G03-F	24		37.2	15.4			66.6
	1/2	KQB2F16-G04-F	27	43.1	20.4	89.1			

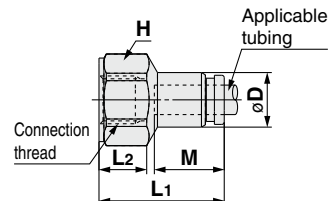

*1 For the ø10, ø12, and ø16, this dimension refers to the O.D. of the release button.
*2 Value of FEP tubing
Value of nylon tubing for ø16 only

EHDG Compliant

Metric M, G KFG2H□-E

Clean Design

Metric M, G KFG2H□-C

FDA Compliant

Metric M, R, Rc KQG2-F

Inch UNF, NPT KQG2-F

Metric G KQG2-F

Metric M, R, Rc KQB2-F

Inch UNF, NPT KQB2-F

Metric G KQB2-F

Metric R, Rc KFG2-F

Inch NPT KFG2-F

Metric G KFG2-F

Precautions

Specific Product Precautions

Be sure to read this before handling the products. Refer to the back cover for safety instructions and pages 75 to 79 for fittings & tubing precautions.



Selection

⚠ Caution

1. The surge pressure must be under the maximum operating pressure. If the surge pressure exceeds the maximum operating pressure, it will result in damage to fittings and tubing or the tubing may result in being fallen out.
2. If using a fluoro resin tubing in an environment where the fluid temperature changes drastically, it is recommended to use an inner sleeve. Otherwise, air leakage may occur or the tube may release from fitting due to deformation of the tubing.
3. The particle generation of the KQB2-F series depends on the operating conditions and operating environment. If you are concerned about the effects on machinery and equipment, check the particle generation with your machine before use.

The components of the KQB2-F series may slide due to changes in the internal pressure, which may generate particles. When using male elbow, male branch tee, and extended male elbow fittings, particles may be generated by rotation for positioning after connecting.

Mounting

⚠ Caution

1. When performing the piping work, turn the tightening tool in the horizontal direction to the hexagon across flats of the stud so that any moment is not applied to the body.

If the tool is in contact with the body, this may cause the stud to come off.

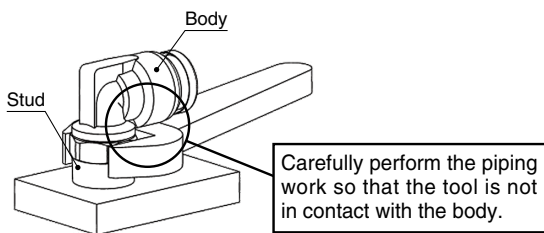

2. The union elbow, union tee, union "Y", different diameter tee and different diameter union "Y" should be fixed through the mounting hole.

Otherwise, air leakage or breaking can occur due to a pulling force or moment load created by the product's weight.

3. The male elbow, male branch tee, and extended male elbow can be turned for positioning after connecting, but they cannot be used while turning them.

Doing so may cause worn out metallic particles to enter the fluid or the fitting to break.

4. If the connection tube oscillates or turns, do not use this product.

Doing so may cause the fitting to break. In particular, for the product with the stud, this may cause the stud to come off.

Cleaning Method

⚠ Warning

1. Check the connection before cleaning.
Clean the fittings with the tube and plug connected and the screw tightened.
2. Review the conditions before cleaning.
Make sure that the fitting material is not affected or damaged by chemical solution, temperature, and water pressure before use.
3. Do not use a metal brush or tool that may damage or scratch the fitting.

Operating Environment

⚠ Caution

1. The table below shows material of parts. Please refer to the relevant standards for parts when determining suitability in applications and operating conditions.

Item	Material	Compliant standards
Pressing parts	Stainless steel	AISI304
Cutting parts	Brass	The NSF/ANSI 51 lead content requirement is satisfied.
Surface treatment	Electroless nickel plating	ASTM corrosion resistance, Intermediate Grade
MIM parts	Stainless steel	AISI316L equivalent
Rubber parts	Fluoropolymer	FDA 21CFR 177.2600
Grease	Paraffin oil	NSF H1

Installation and Removal of Tubing

⚠ Caution

1. Removal of tubing
1) For tubing used at a high temperature or for an extended period of time, there is a possibility that it will not fit into a One-touch fitting again due to an enlarged O.D. Dispose of the tubing and replace it with a new one.

Proper Tightening Torque of Fittings

⚠ Caution

1. Connection thread tightening method: M5, 10-32UNF
Tighten fittings with a tightening torque of 1 to 1.5 N·m.
2. Connection thread tightening method: G
Tighten fittings with sealant using the proper tightening torques in the table below. If tightened using a torque exceeding the proper torque level, this may cause the fitting to break. In particular, for the product with the stud, the stud may come off.

G Thread Proper Tightening Torque

Connection thread size	Proper tightening torque [N·m]
G1/8	2.9 to 3.2
G1/4	5.7 to 6.3
G3/8	9.5 to 10.5
G1/2	14.3 to 15.8

Variations

Male Connector

KFG2H

Metric	p. 61
Inch	p. 67



Bulkhead Union

KFG2E

Metric	p. 63
Inch	p. 68

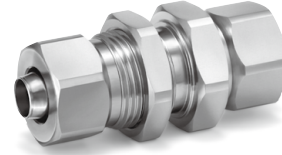

Male Elbow

KFG2L

Metric	p. 61
Inch	p. 67



Union Elbow

KFG2L

Metric	p. 63
Inch	p. 68



Male Branch Tee

KFG2T

Metric	p. 62
Inch	p. 67

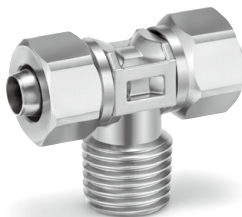

Swivel Elbow

KFG2V

Metric	R thread	p. 63
	G thread	p. 72
Inch		p. 69



Straight Union

KFG2H

Metric	p. 62
Inch	p. 68

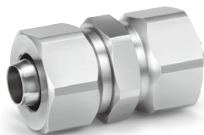

Female Connector

KFG2F

Metric	p. 64
Inch	p. 69



Union Tee

KFG2T

Metric	p. 62
Inch	p. 68

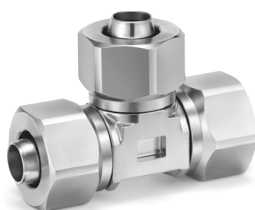

Union Nut

KFG2N

Metric	p. 64
Inch	p. 69



EHDG
Compliant

Metric M, G
KFG2H□-E

Clean
Design

Metric M, G
KFG2H□-C

FDA
Compliant

Metric M, R, Rc
KQG2-F

Inch UNF, NPT
KQG2-F

Metric G
KQG2-F

Metric M, R, Rc
KQB2-F

Inch UNF, NPT
KQB2-F

Metric G
KQB2-F

Metric R, Rc
KFG2-F

Inch NPT
KFG2-F

Metric G
KFG2-F

Precautions

Stainless Steel 316 Insert Fittings

Applicable Tubing: Metric Size, Connection Thread: R, Rc

KFG2-F Series



Applicable Tubing

Tubing material*1, *2	FEP, PFA, Modified PTFE, 2-layer soft fluoropolymer, Nylon, Soft nylon, Polyurethane, Soft polyurethane, Polyolefin, Soft polyolefin, Antistatic soft nylon, Antistatic polyurethane, Hard polyurethane
Tubing size	ø4 x ø2.5, ø4 x ø3, ø6 x ø4, ø8 x ø6, ø10 x ø7.5, ø10 x ø8, ø12 x ø9, ø12 x ø10, ø16 x ø13

*1 Considering the product application, FDA-compliant products are recommended.

*2 For soft polyurethane tubing, hard polyurethane tubing, and antistatic polyurethane tubing, water cannot be used.

Series	Tubing material	Tubing O.D. x I.D. [mm]									
		ø4 x ø2.5	ø4 x ø3	ø6 x ø4	ø8 x ø6	ø10 x ø7.5	ø10 x ø8	ø12 x ø9	ø12 x ø10	ø16 x ø13	
TH	FEP*1	●	—	●	●	●	●	●	●	—	
TL	Super PFA*1	—	●	●	●	—	●	—	●	—	
TLM	PFA*1	●	●	●	●	●	●	●	●	●	
TD	Modified PTFE*1	●	—	●	●	●	—	●	—	—	
TQ	Special fluoropolymer	●	—	●	●	—	●	●	—	—	
T	Nylon	●	●	●	●	●	—	●	—	●	
TS	Soft nylon	●	—	●	●	●	—	●	—	—	
TU	Polyurethane	●	—	●	—	—	—	—	—	—	
TU-X214	Polyurethane*1	●	—	●	—	—	—	—	—	—	
TPH	Polyolefin*1	●	—	●	●	●	—	●	—	—	
TUS	Soft polyurethane	●	—	●	—	—	—	—	—	—	
TUH	Hard polyurethane (High pressure)	●	—	●	—	—	—	—	—	—	
TPS	Soft polyolefin*1	●	—	●	—	—	—	—	—	—	
TAS	Antistatic soft nylon	●	—	●	—	—	—	—	—	—	
TAU	Antistatic polyurethane	●	—	●	—	—	—	—	—	—	

*1 FDA compliant tubing (Refer to page 4.)

Spare Parts

Description	Tubing O.D.	Part no.	Material
Bulkhead nut	ø4	KFG204-P01	Stainless steel 316
	ø6	KFG206-P01	
	ø8	KFG208-P01	
	ø10	KFG210-P01	
	ø12	KFG212-P01	
	ø16	KFG216-P01	

Specifications

Fluid	Air, Water*1, Steam*3
Operating pressure range*2	-100 kPa to 1 MPa*4
Proof pressure	3.0 MPa
Ambient and fluid temperatures	-65 to 260°C (No freezing)*4 [Swivel elbow: -5 to 150°C]
Lubricant	NSF H1 grease
Seal on the threads	Without sealant

*1 Deionized water is not recommended for use as it may affect the material used in the fittings. In addition, it is known to degrade the water quality.

*2 Do not use the fittings with a leak tester or for vacuum retention because they are not guaranteed for zero leakage.

*3 Please contact SMC for applicable tubing separately.

*4 Check the operating pressure range and operating temperature range of the tubing.

How to Order

KFG2 H 0425 - 02 - F

Body type

Symbol	Model
H	Male connector, Straight union
L	Male elbow, Union elbow
T	Male branch tee, Union tee
E	Bulkhead union
V	Swivel elbow
F	Female connector

FDA compliant

Thread size

Symbol	Size
01	R1/8
02	R1/4, Rc1/4
03	R3/8, Rc3/8
04	R1/2, Rc1/2

* Sealant is unavailable for this product as no FDA-compliant material is available.

Tubing size (Metric)

Symbol	O.D.	I.D.
0425	ø4	ø2.5
0403	ø4	ø3
0604	ø6	ø4
0806	ø8	ø6
1075	ø10	ø7.5
1008	ø10	ø8
1209	ø12	ø9
1210	ø12	ø10
1613	ø16	ø13

Construction

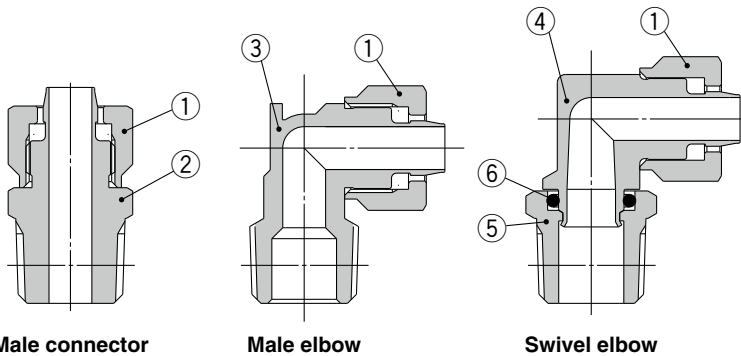

Principal Parts Material

No.	Description	Material	Note
1	Union nut	Stainless steel 316	NSF H1 grease
2	Male connector body	Stainless steel 316	
3	Male elbow body	Stainless steel 316	
4	Swivel elbow body	Stainless steel 316	NSF H1 grease
5	Stud	Stainless steel 316	
6	O-ring	FDA compliant FKM	NSF H1 grease

EHEDG Compliant

Metric M, G KFG2H-E

Clean Design

Metric M, G KFG2H-C

FDA Compliant

Metric M, R, Rc KQG2-F

Inch UNF, NPT KQG2-F

Metric G KQG2-F

Metric M, R, Rc KQB2-F

Inch UNF, NPT KQB2-F

Metric G KQB2-F

Metric R, Rc KFG2-F

Inch NPT KFG2-F

Metric G KFG2-F

Precautions

KFG2-F Series

Applicable Tubing: Metric Size, Connection Thread: R, Rc

Dimensions

Male Connector: KFG2H



Applicable tubing size [mm]		Connection thread R	Model	Width across flats		L	M	ød	A*1	Effective area [mm ²]	Weight [g]
O.D.	I.D.			H1	H2						
ø4	ø2.5	1/8	KFG2H0425-01-F	10	8	19.4	5	1.8	16.3	1.6	8
		1/4	KFG2H0425-02-F	14		23.8					14
ø4	ø3	1/8	KFG2H0403-01-F	10	8	19.4	5	2.3	16.3	2.6	8
		1/4	KFG2H0403-02-F	14		23.8					14
ø6	ø4	1/8	KFG2H0604-01-F	10	10	20.9	5.8	3.3	17.8	6	10
		1/4	KFG2H0604-02-F	14		25.3					16
ø8	ø6	1/8	KFG2H0806-01-F	14	14	23.3	6.6	5.3	20.2	17	18
		1/4	KFG2H0806-02-F			26.7					24
		3/8	KFG2H0806-03-F			28.1					36
ø10	ø7.5	1/4	KFG2H1075-02-F	17	17	29.7	7.6	6.8	25	30	34
		3/8	KFG2H1075-03-F			30.1					41
		1/2	KFG2H1075-04-F			33.5					67
ø10	ø8	1/4	KFG2H1008-02-F	17	17	29.7	7.3	25	35	35	33
		3/8	KFG2H1008-03-F			30.1					40
		1/2	KFG2H1008-04-F			33.5					66
ø12	ø9	1/4	KFG2H1209-02-F	17	17	31.3	8.5	8	26.6	45	33
		3/8	KFG2H1209-03-F			31.7					40
		1/2	KFG2H1209-04-F			35.1					66
ø12	ø10	1/4	KFG2H1210-02-F	17	17	31.3	9	26.6	57	57	30
		3/8	KFG2H1210-03-F			31.7					38
		1/2	KFG2H1210-04-F			35.1					63
ø16	ø13	3/8	KFG2H1613-03-F	22	22	33.1	9.3	12	28	101	51
		1/2	KFG2H1613-04-F			36.3					67

*1 Reference dimensions after installation of R thread

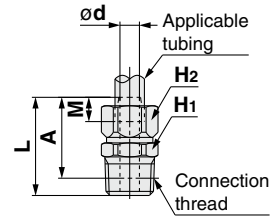

Male Elbow: KFG2L



Applicable tubing size [mm]		Connection thread R	Model	Width across flats	Width across flats	L1	L2	M	ød	A*1	Effective area [mm ²]	Weight [g]
O.D.	I.D.			H1	H2							
ø4	ø2.5	1/8	KFG2L0425-01-F	10	8	13.5	5	1.8	13.8	1.6	10	
		1/4	KFG2L0425-02-F								15.9	14
ø4	ø3	1/8	KFG2L0403-01-F	10	8	13.5	5	2.3	13.8	2.6	10	
		1/4	KFG2L0403-02-F								15.9	14
ø6	ø4	1/8	KFG2L0604-01-F	10	10	15	5.8	3.3	16	6	12	
		1/4	KFG2L0604-02-F								17	16
ø8	ø6	1/8	KFG2L0806-01-F	12	14	17.4	6.6	5.3	20.4	12	20	
		1/4	KFG2L0806-02-F								19.2	24
		3/8	KFG2L0806-03-F								19.6	27
ø10	ø7.5	1/4	KFG2L1075-02-F	15	17	20.9	7.6	6.8	25.6	23	38	
		3/8	KFG2L1075-03-F								21.3	41
		1/2	KFG2L1075-04-F								24.5	51
ø10	ø8	1/4	KFG2L1008-02-F	15	17	20.9	7.3	25.6	27	37	37	
		3/8	KFG2L1008-03-F								21.3	41
		1/2	KFG2L1008-04-F								24.5	50
ø12	ø9	1/4	KFG2L1209-02-F	16	17	23.5	8.5	8	25.6	35	41	
		3/8	KFG2L1209-03-F								21.3	45
		1/2	KFG2L1209-04-F								24.5	57
ø12	ø10	1/4	KFG2L1210-02-F	16	17	23.5	9	25.6	34	42	42	
		3/8	KFG2L1210-03-F								21.3	43
		1/2	KFG2L1210-04-F								24.5	53
ø16	ø13	3/8	KFG2L1613-03-F	21	22	26.2	9.3	12	31	79	72	
		1/2	KFG2L1613-04-F								27.2	78

*1 Reference dimensions after installation of R thread

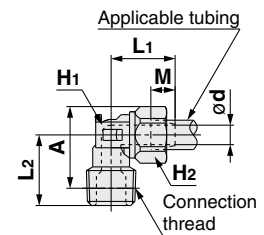

Dimensions

Male Branch Tee: KFG2T



Applicable tubing size [mm]		Connection thread R	Model	Width across flats		L1	L2	M	ød	A*1	Effective area [mm²]	Weight [g]
O.D.	I.D.			H1	H2							
ø4	ø2.5	1/8	KFG2T0425-01-F	10	8	13.5	5	1.8	13.8	3	13	
		1/4	KFG2T0425-02-F								17	
ø4	ø3	1/8	KFG2T0403-01-F	10	8	13.5	5	2.3	13.8	5	12	
		1/4	KFG2T0403-02-F								17	
ø6	ø4	1/8	KFG2T0604-01-F	10	10	15	5.8	3.3	16	10	17	
		1/4	KFG2T0604-02-F								21	
ø8	ø6	1/8	KFG2T0806-01-F	12	14	17.4	6.6	5.3	20.4	16	30	
		1/4	KFG2T0806-02-F								34	
		3/8	KFG2T0806-03-F								38	
ø10	ø7.5	1/4	KFG2T1075-02-F	15	17	20.9	7.6	6.8	25.6	30	55	
		3/8	KFG2T1075-03-F								59	
		1/2	KFG2T1075-04-F								68	
ø10	ø8	1/4	KFG2T1008-02-F	15	17	20.9	7.6	7.3	25.6	35	54	
		3/8	KFG2T1008-03-F								58	
		1/2	KFG2T1008-04-F								67	
ø12	ø9	1/4	KFG2T1209-02-F	16	17	23.5	8.5	8	25.6	32	59	
		3/8	KFG2T1209-03-F								63	
		1/2	KFG2T1209-04-F								72	
ø12	ø10	1/4	KFG2T1210-02-F	16	17	23.5	8.5	9	25.6	41	57	
		3/8	KFG2T1210-03-F								60	
		1/2	KFG2T1210-04-F								69	
ø16	ø13	3/8	KFG2T1613-03-F	21	22	26.2	9.3	12	31	108	98	
		1/2	KFG2T1613-04-F								106	

*1 Reference dimensions after installation of R thread

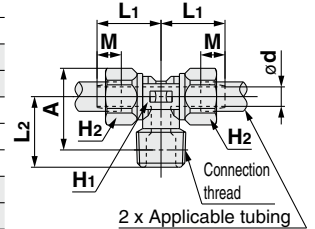

Straight Union: KFG2H



Applicable tubing size [mm]		Model	Width across flats		L	M	ød	Effective area [mm²]	Weight [g]
O.D.	I.D.		H1	H2					
ø4	ø2.5	KFG2H0425-00-F	8	8	21.8	5	1.8	1.6	7
		KFG2H0403-00-F							
ø4	ø3	KFG2H0604-00-F	10	10	24.8	5.8	3.3	6	11
		KFG2H0806-00-F							
ø8	ø6	KFG2H1075-00-F	14	14	28.6	6.6	5.3	17	25
		KFG2H1209-00-F							
ø10	ø7.5	KFG2H1008-00-F	17	17	33.6	7.6	6.8	30	43
		KFG2H1210-00-F							
ø12	ø9	KFG2H1209-00-F	17	17	37	8.5	8	45	44
		KFG2H1210-00-F							
ø16	ø13	KFG2H1613-00-F	22	22	39.4	9.3	12	101	71
		KFG2H1613-00-F							

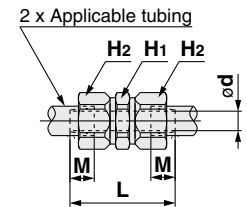

Union Tee: KFG2T



Applicable tubing size [mm]		Model	Width across flats		L	M	ød	Effective area [mm²]	Weight [g]
O.D.	I.D.		H1	H2					
ø4	ø2.5	KFG2T0425-00-F	7	8	13.3	5	1.8	1.6	11
		KFG2T0403-00-F							
ø6	ø4	KFG2T0604-00-F	9	10	15.8	5.8	3.3	6	18
		KFG2T0806-00-F							
ø8	ø6	KFG2T1075-00-F	12	14	18.7	6.6	5.3	17	39
		KFG2T1209-00-F							
ø10	ø7.5	KFG2T1008-00-F	15	17	22.2	7.6	6.8	30	67
		KFG2T1210-00-F							
ø12	ø9	KFG2T1209-00-F	16	17	24.3	8.5	8	45	71
		KFG2T1210-00-F							
ø16	ø13	KFG2T1613-00-F	21	22	28	9.3	12	101	122
		KFG2T1613-00-F							

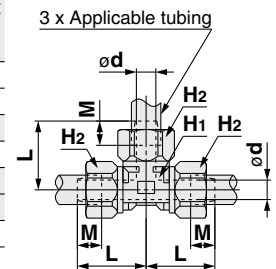

EHEDG Compliant

Metric M, G KFG2H□-E

Clean Design

Metric M, G KFG2H□-C

FDA Compliant

Metric M, R, Rc KQG2-F

Inch UNF, NPT KQG2-F

Metric G KQG2-F

Metric M, R, Rc KQB2-F

Inch UNF, NPT KQB2-F

Metric G KQB2-F

Metric R, Rc KFG2-F

Inch NPT KFG2-F

Metric G KFG2-F

Precautions

KFG2-F Series

Applicable Tubing: Metric Size, Connection Thread: R, Rc

Dimensions

Bulkhead Union: KFG2E



Applicable tubing size [mm]		Model	Width across flats			L1	L2	M	ød	Mounting hole	Effective area [mm ²]	Weight [g]
O.D.	I.D.		H1	H2	H3							
ø4	ø2.5	KFG2E0425-00-F	12	8	12	32.6	29	5	1.8	11	1.6	16
ø4	ø3	KFG2E0403-00-F							2.3		2.6	
ø6	ø4	KFG2E0604-00-F	14	10	14	36.6	32.2	5.8	3.3	13	6	25
ø8	ø6	KFG2E0806-00-F	17	14	17	40.4	35.8	6.6	5.3	15	17	43
ø10	ø7.5	KFG2E1075-00-F							6.8	18	30	69
ø10	ø8	KFG2E1008-00-F	21	17	21	44.8	39.4	7.6	7.3		35	68
ø12	ø9	KFG2E1209-00-F							8	19	45	71
ø12	ø10	KFG2E1210-00-F	21	17	21	48.1	41.7	8.5	9		57	68
ø16	ø13	KFG2E1613-00-F	27	22	27	52.3	45.9	9.3	12	25	101	122

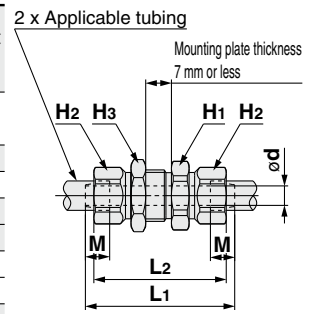

Union Elbow: KFG2L



Applicable tubing size [mm]		Model	Width across flats	Width across flats	L	M	ød	Effective area [mm ²]	Weight [g]
O.D.	I.D.		H1	H2					
ø4	ø2.5	KFG2L0425-00-F	7	8	13.3	5	1.8	1.6	8
ø4	ø3	KFG2L0403-00-F					2.3	2.6	
ø6	ø4	KFG2L0604-00-F	9	10	15.8	5.8	3.3	6	13
ø8	ø6	KFG2L0806-00-F	12	14	18.7	6.6	5.3	17	28
ø10	ø7.5	KFG2L1075-00-F					6.8	30	47
ø10	ø8	KFG2L1008-00-F	15	17	22.2	7.6	7.3	35	46
ø12	ø9	KFG2L1209-00-F					8	45	51
ø12	ø10	KFG2L1210-00-F	16	17	24.3	8.5	9	57	48
ø16	ø13	KFG2L1613-00-F	21	22	28	9.3	12	101	89

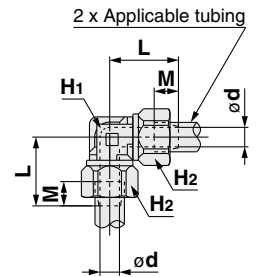

Swivel Elbow: KFG2V



Applicable tubing size [mm]		Connection thread R	Model	Width across flats	Width across flats		L1	L2	M	ød	A*1	Effective area [mm ²]	Weight [g]	
O.D.	I.D.			H1	H2	H3								
ø4	ø2.5	1/8	KFG2V0425-01-F	7	8	10	14.5	16.1	5	1.8	17.4	1.4	9	
			KFG2V0425-02-F			14							19.9	18
			KFG2V0403-01-F			10							16.1	9
ø4	ø3	1/4	KFG2V0403-02-F			14		19.9		2.3	19.6	2.3	18	
			KFG2V0604-01-F	9	10	10	16	17.2	5.8	3.3	19.6	5	12	
ø6	ø4	1/4	KFG2V0604-02-F			14		21			21.8		21	
			KFG2V0806-01-F	12	14	12	18.4	20.1	6.6	5.3	24.7		22	
ø8	ø6	1/4	KFG2V0806-02-F			14		23.3			26.3	14	30	
			KFG2V0806-03-F	12	14	17		24.7			27.3		42	
			KFG2V1075-02-F			14		25			29.6		37	
ø10	ø7.5	3/8	KFG2V1075-03-F	15	17	17	21.4	26.4	7.6	6.8	30.6	25	47	
			KFG2V1075-04-F			22							30.6	74
			KFG2V1008-02-F			14							25	36
ø10	ø8	3/8	KFG2V1008-03-F			17		26.4		7.3	30.6	29	46	
			KFG2V1008-04-F	15	17	22		30.6			33.5		73	
			KFG2V1209-02-F			14		25			29.6		38	
ø12	ø9	3/8	KFG2V1209-03-F	16	17	17	23	26.4	8.5	8	30.6	38	49	
			KFG2V1209-04-F			22							30.6	75
			KFG2V1210-02-F			14							25	40
ø12	ø10	3/8	KFG2V1210-03-F			17	24.5	26.4	9	30.6	48	51		
			KFG2V1210-04-F	22	30.6	77								
			KFG2V1613-03-F	21	22	19							26.7	29.3
ø16	ø13	1/2	KFG2V1613-04-F			22		33.3		39		96		

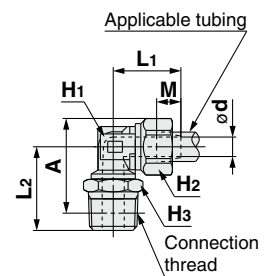

*1 Reference dimensions after installation of R thread

Dimensions

Female Connector: KFG2F



Applicable tubing size [mm]		Connection thread Rc	Model	Width across flats		L1	L2	M	ød	Effective area [mm ²]		Weight [g]
O.D.	I.D.			H1	H2							
ø4	ø2.5	1/4	KFG2F0425-02-F	17	8	25.9	16.4	5	1.8	1.6	24	
ø4	ø3	1/4	KFG2F0403-02-F						2.3	2.6		
ø6	ø4	1/4	KFG2F0604-02-F	17	10	26.8	15.8	5.8	3.3	6	25	
ø8	ø6	3/8	KFG2F0806-03-F	19	14	28.8	16.4	6.6	5.3	17	31	
ø10	ø7.5	3/8	KFG2F1075-03-F	19	17	30	15.6	7.6	6.8	30	36	
ø10	ø8	3/8	KFG2F1008-03-F						7.3	35		
ø12	ø9	3/8	KFG2F1209-03-F	19	17	31.2	15.2	8.5	8	45	36	
ø12	ø10	3/8	KFG2F1210-03-F						9	57		
ø16	ø13	1/2	KFG2F1613-04-F	24	22	37.7	20.5	9.3	12	101	71	

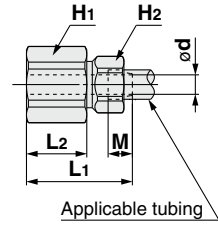

Union Nut: KFG2N



Applicable tubing O.D. [mm]	Model	H (Width across flats)	L	Weight [g]
ø4	KFG2N-04-F	8	7.7	1.9
ø6	KFG2N-06-F	10	8.8	3
ø8	KFG2N-08-F	14	10.1	6.7
ø10	KFG2N-10-F	17	11.7	10.5
ø12	KFG2N-12-F	17	12.8	9.6
ø16	KFG2N-16-F	22	14	15.3

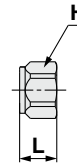

EHEDG Compliant

Metric M, G
KFG2H□-E

Clean Design

Metric M, G
KFG2H□-C

FDA Compliant

Metric M, R, Rc
KQG2-F

Inch UNF, NPT
KQG2-F

Metric G
KQG2-F

Metric M, R, Rc
KQB2-F

Inch UNF, NPT
KQB2-F

Metric G
KQB2-F

Metric R, Rc
KFG2-F

Inch NPT
KFG2-F

Metric G
KFG2-F

Precautions

Stainless Steel 316 Insert Fittings

Applicable Tubing: Inch Size, Connection Thread: NPT

KFG2-F Series



Applicable Tubing

Tubing material*1, *2	FEP, PFA, Modified PTFE, Nylon, Soft nylon, Polyurethane, Soft polyurethane, Polyolefin, Soft polyolefin, Antistatic soft nylon, Antistatic polyurethane, Hard polyurethane
Tubing size	$\phi 1/8" \times \phi 0.086"$, $\phi 5/32" \times \phi 0.098"$, $\phi 1/4" \times \phi 5/32"$ $\phi 5/16" \times 0.236"$, $\phi 3/8" \times \phi 1/4"$, $\phi 1/2" \times \phi 3/8"$

*1 Considering the product application, FDA-compliant products are recommended.

*2 For soft polyurethane tubing, hard polyurethane tubing, and antistatic polyurethane tubing, water cannot be used.

Series	Tubing material	Tubing O.D. x I.D. [inch]					
		$\phi 1/8" \times \phi 0.086"$ ($\phi 3.18 \times \phi 2.18$)	$\phi 5/32" \times \phi 0.098"$ ($\phi 4 \times \phi 2.5$)	$\phi 1/4" \times \phi 5/32"$ ($\phi 6.35 \times \phi 3.95$)	$\phi 5/16" \times \phi 0.236"$ ($\phi 8 \times \phi 6$)	$\phi 3/8" \times \phi 1/4"$ ($\phi 9.53 \times \phi 6.35$)	$\phi 1/2" \times \phi 3/8"$ ($\phi 12.7 \times \phi 9.53$)
TH/TIH	FEP*1	●	●	●	●	●	●
TL/TIL	Super PFA*1	●	—	●	●	●	●
TLM/TILM	PFA*1	●	●	●	●	●	●
TD/TID	Modified PTFE*1	●	●	●	●	●	●
T/TIA	Nylon	●	●	—	●	—	●
TS/TISA	Soft nylon	●	●	—	●	—	●
TU/TIUB	Polyurethane	—	●	—	—	●	—
TU-X214	Polyurethane*1	—	●	●	—	—	—
TPH	Polyolefin*1	—	●	—	●	—	—
TUS	Soft polyurethane	—	●	—	—	—	—
TUH	Hard polyurethane (High pressure)	—	●	—	—	—	—
TPS	Soft polyolefin*1	—	●	—	—	—	—
TAS	Antistatic soft nylon	—	●	—	—	—	—
TAU	Antistatic polyurethane	—	●	—	—	—	—

*1 FDA compliant tubing (Refer to page 4.)

Spare Parts

Description	Tubing O.D.	Part no.	Material
Bulkhead nut	$\phi 1/8"$	KFG201-P01	Stainless steel 316
	$\phi 5/32"$	KFG203-P01	
	$\phi 1/4"$	KFG207-P01	
	$\phi 5/16"$	KFG209-P01	
	$\phi 3/8"$	KFG211-P01	
	$\phi 1/2"$	KFG213-P01	

Specifications

Fluid	Air, Water*1, Steam*3
Operating pressure range*2	-100 kPa to 1 MPa*4
Proof pressure	3.0 MPa
Ambient and fluid temperatures	-65 to 260°C (No freezing)*4 [Swivel elbow: -5 to 150°C]
Lubricant	NSF H1 grease
Seal on the threads	Without sealant

*1 Deionized water is not recommended for use as it may affect the material used in the fittings. In addition, it is known to degrade the water quality.

*2 Do not use the fittings with a leak tester or for vacuum retention because they are not guaranteed for zero leakage.

*3 Please contact SMC for applicable tubing separately.

*4 Check the operating pressure range and operating temperature range of the tubing.

How to Order

KFG2 H 0122 - N 01 - F

• **Body type**

Symbol	Model
H	Male connector, Straight union
L	Male elbow, Union elbow
T	Male branch tee, Union tee
E	Bulkhead union
V	Swivel elbow
F	Female connector

• **FDA compliant**

• **Thread size**

Symbol	Size
01	NPT1/8
02	NPT1/4
03	NPT3/8
04	NPT1/2

* Sealant is unavailable for this product as no FDA-compliant material is available.

• **Thread type**

Symbol	Type
N	NPT

• **Tubing size (Inch)**

Symbol	O.D.	I.D.
0122	ø 1/8"	ø0.086"
0325	ø5/32"	ø0.098"
0704	ø 1/4"	ø5/32"
0906	ø5/16"	ø0.236"
1163	ø3/8"	ø 1/4"
1395	ø 1/2"	ø3/8"

Construction

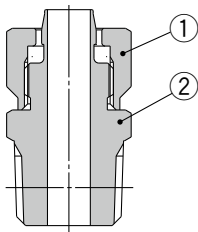

Male connector

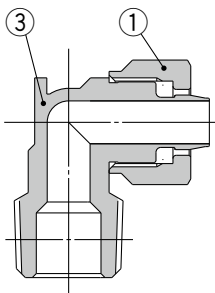

Male elbow

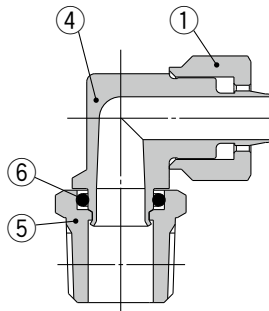

Swivel elbow

Principal Parts Material

No.	Description	Material	Note
1	Union nut	Stainless steel 316	NSF H1 grease
2	Male connector body	Stainless steel 316	
3	Male elbow body	Stainless steel 316	
4	Swivel elbow body	Stainless steel 316	NSF H1 grease
5	Stud	Stainless steel 316	
6	O-ring	FDA compliant FKM	NSF H1 grease

EHEDG Compliant

Metric M, G KFG2H-E

Clean Design

Metric M, G KFG2H-C

FDA Compliant

Metric M, R, Rc KQG2-F

Inch UNF, NPT KQG2-F

Metric G KQG2-F

Metric M, R, Rc KQB2-F

Inch UNF, NPT KQB2-F

Metric G KQB2-F

Metric R, Rc KFG2-F

Inch NPT KFG2-F

Metric G KFG2-F

Precautions

KFG2-F Series

Applicable Tubing: Inch Size, Connection Thread: NPT

Dimensions

Male Connector: KFG2H



Applicable tubing size [inch]		Connection thread NPT	Model	Width across flats		L	M	ød	A*1	Effective area [mm ²]	Weight [g]
O.D.	I.D.			H1	H2						
ø 1/8" (ø3.18)	ø0.086" (ø2.18)	1/8	KFG2H0122-N01-F	12	8	19.4	5	1.5	16.2	1.1	9
		1/4	KFG2H0122-N02-F	14		23.8			19.4		
ø 5/32" (ø4)	ø0.098" (ø2.5)	1/8	KFG2H0325-N01-F	12	8	19.4	5	1.8	16.2	1.6	9
		1/4	KFG2H0325-N02-F	14		23.8			19.4		
ø 1/4" (ø6.35)	ø5/32" (ø3.95)	1/8	KFG2H0704-N01-F	12	12	21.1	6	3.3	17.9	6	13
		1/4	KFG2H0704-N02-F	14		25.5			21.1		
ø 5/16" (ø8)	ø0.236" (ø6)	1/8	KFG2H0906-N01-F	14	14	23.3	6.6	5.3	20.1	17	18
		1/4	KFG2H0906-N02-F			26.7			22.3		
		3/8	KFG2H0906-N03-F			28.3			23.6		
ø 3/8" (ø9.53)	ø 1/4" (ø6.35)	1/4	KFG2H1163-N02-F	17	17	29.7	7.6	5.6	25.3	19	37
		3/8	KFG2H1163-N03-F	19		30.3			25.6		
		1/2	KFG2H1163-N04-F	22		33.5			27.1		
ø 1/2" (ø12.7)	ø 3/8" (ø9.53)	1/4	KFG2H1395-N02-F	19	19	31.5	8.5	8.5	27.1	40.1	40
		3/8	KFG2H1395-N03-F			31.9			27.2		
		1/2	KFG2H1395-N04-F			35.1			28.7		

*1 Reference dimensions after installation of NPT thread

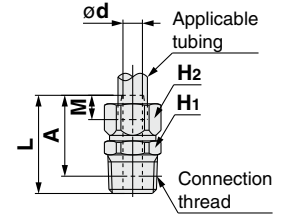

Male Elbow: KFG2L



Applicable tubing size [inch]		Connection thread NPT	Model	Width across flats	Width across flats	L1	L2	M	ød	A*1	Effective area [mm ²]	Weight [g]
O.D.	I.D.			H1	H2							
ø 1/8" (ø3.18)	ø0.086" (ø2.18)	1/8	KFG2L0122-N01-F	10	8	13.5	12.5	5	1.5	13.7	1.1	10
		1/4	KFG2L0122-N02-F	14		15.9	15.9					
ø 5/32" (ø4)	ø0.098" (ø2.5)	1/8	KFG2L0325-N01-F	10	8	13.5	12.5	5	1.8	13.7	1.6	10
		1/4	KFG2L0325-N02-F	14		15.9	15.9					
ø 1/4" (ø6.35)	ø5/32" (ø3.95)	1/8	KFG2L0704-N01-F	10	12	15.2	14.7	6	3.3	18.1	6	15
		1/4	KFG2L0704-N02-F	14		18.1	20.3					
ø 5/16" (ø8)	ø0.236" (ø6)	1/8	KFG2L0906-N01-F	12	14	17.4	15.8	6.6	5.3	20.3	12	20
		1/4	KFG2L0906-N02-F			19.2	22.5					
		3/8	KFG2L0906-N03-F			19.6	22.6					
ø 3/8" (ø9.53)	ø 1/4" (ø6.35)	1/4	KFG2L1163-N02-F	15	17	20.4	20.9	7.6	5.6	25.9	13	39
		3/8	KFG2L1163-N03-F			21.3	26.0					
		1/2	KFG2L1163-N04-F			24.5	27.5					
ø 1/2" (ø12.7)	ø 3/8" (ø9.53)	1/4	KFG2L1395-N02-F	17	19	23.3	21.9	8.5	8.5	27.9	30	48
		3/8	KFG2L1395-N03-F			22.3	28					
		1/2	KFG2L1395-N04-F			25.5	29.5					

*1 Reference dimensions after installation of NPT thread

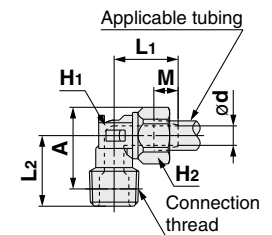

Male Branch Tee: KFG2T



Applicable tubing size [inch]		Connection thread NPT	Model	Width across flats	Width across flats	L1	L2	M	ød	A*1	Effective area [mm ²]	Weight [g]
O.D.	I.D.			H1	H2							
ø 1/8" (ø3.18)	ø0.086" (ø2.18)	1/8	KFG2T0122-N01-F	10	8	13.5	12.5	5	1.5	13.7	2	13
		1/4	KFG2T0122-N02-F	14		15.9	15.9					
ø 5/32" (ø4)	ø0.098" (ø2.5)	1/8	KFG2T0325-N01-F	10	8	13.5	12.5	5	1.8	13.7	3	13
		1/4	KFG2T0325-N02-F	14		15.9	15.9					
ø 1/4" (ø6.35)	ø5/32" (ø3.95)	1/8	KFG2T0704-N01-F	10	12	15.2	14.7	6	3.3	18.1	10	22
		1/4	KFG2T0704-N02-F	14		18.1	20.3					
ø 5/16" (ø8)	ø0.236" (ø6)	1/8	KFG2T0906-N01-F	12	14	17.4	15.8	6.6	5.3	20.3	16	31
		1/4	KFG2T0906-N02-F			19.2	22.5					
		3/8	KFG2T0906-N03-F			19.6	22.6					
ø 3/8" (ø9.53)	ø 1/4" (ø6.35)	1/4	KFG2T1163-N02-F	15	17	20.4	20.9	7.6	5.6	25.9	18	58
		3/8	KFG2T1163-N03-F			21.3	26.0					
		1/2	KFG2T1163-N04-F			24.5	27.5					
ø 1/2" (ø12.7)	ø 3/8" (ø9.53)	1/4	KFG2T1395-N02-F	17	19	23.3	21.9	8.5	8.5	27.9	36	70
		3/8	KFG2T1395-N03-F			22.3	28					
		1/2	KFG2T1395-N04-F			25.5	29.5					

*1 Reference dimensions after installation of NPT thread

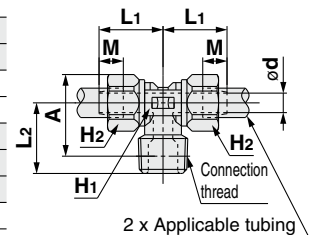

Dimensions

Straight Union: KFG2H



Applicable tubing size [inch]		Model	Width across flats		L	M	ød	Effective area [mm ²]	Weight [g]
O.D.	I.D.		H ₁	H ₂					
ø1/8" (ø3.18)	ø0.086" (ø2.18)	KFG2H0122-00-F	8	8	21.8	5	1.5	1.1	7
ø5/32" (ø4)	ø0.098" (ø2.5)	KFG2H0325-00-F	8	8	21.8	5	1.8	1.6	7
ø1/4" (ø6.35)	ø5/32" (ø3.95)	KFG2H0704-00-F	12	12	25.2	6	3.3	6	16
ø5/16" (ø8)	ø0.236" (ø6)	KFG2H0906-00-F	14	14	28.6	6.6	5.3	17	25
ø3/8" (ø9.53)	ø1/4" (ø6.35)	KFG2H1163-00-F	17	17	33.6	7.6	5.6	19	45
ø1/2" (ø12.7)	ø3/8" (ø9.53)	KFG2H1395-00-F	19	19	37	8.5	8.5	51	55

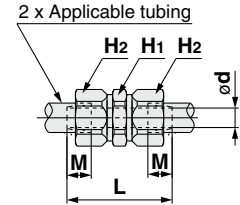

Union Tee: KFG2T



Applicable tubing size [inch]		Model	Width across flats		L	M	ød	Effective area [mm ²]	Weight [g]
O.D.	I.D.		H ₁	H ₂					
ø1/8" (ø3.18)	ø0.086" (ø2.18)	KFG2T0122-00-F	7	8	13.3	5	1.5	1.1	11
ø5/32" (ø4)	ø0.098" (ø2.5)	KFG2T0325-00-F	7	8	13.3	5	1.8	1.6	11
ø1/4" (ø6.35)	ø5/32" (ø3.95)	KFG2T0704-00-F	10	12	16.5	6	3.3	6	26
ø5/16" (ø8)	ø0.236" (ø6)	KFG2T0906-00-F	12	14	18.7	6.6	5.3	17	39
ø3/8" (ø9.53)	ø1/4" (ø6.35)	KFG2T1163-00-F	15	17	22.2	7.6	5.6	19	70
ø1/2" (ø12.7)	ø3/8" (ø9.53)	KFG2T1395-00-F	17	19	24.8	8.5	8.5	51	87

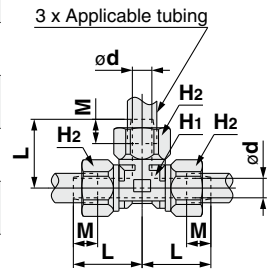

Bulkhead Union: KFG2E



Applicable tubing size [inch]		Model	Width across flats			L ₁	L ₂	M	ød	Mounting hole	Effective area [mm ²]	Weight [g]
O.D.	I.D.		H ₁	H ₂	H ₃							
ø1/8" (ø3.18)	ø0.086" (ø2.18)	KFG2E0122-00-F	12	8	12	32.8	29.4	5	1.5	10	1.1	16
ø5/32" (ø4)	ø0.098" (ø2.5)	KFG2E0325-00-F	12	8	12	32.6	29	5	1.8	11	1.6	16
ø1/4" (ø6.35)	ø5/32" (ø3.95)	KFG2E0704-00-F	17	12	17	39	34.6	6	3.3	13.5	6	39
ø5/16" (ø8)	ø0.236" (ø6)	KFG2E0906-00-F	17	14	17	40.4	35.8	6.6	5.3	15	17	43
ø3/8" (ø9.53)	ø1/4" (ø6.35)	KFG2E1163-00-F	22	17	22	46.8	41.4	7.6	5.6	20	19	84
ø1/2" (ø12.7)	ø3/8" (ø9.53)	KFG2E1395-00-F	26	19	26	51.9	45.5	8.5	8.5	23	51	117

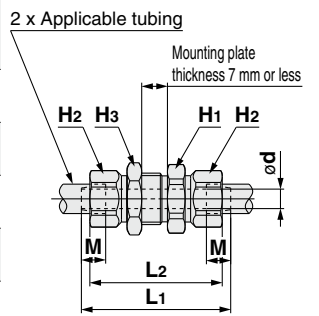

Union Elbow: KFG2L



Applicable tubing size [inch]		Model	Width across flats		L	M	ød	Effective area [mm ²]	Weight [g]
O.D.	I.D.		H ₁	H ₂					
ø1/8" (ø3.18)	ø0.086" (ø2.18)	KFG2L0122-00-F	7	8	13.3	5	1.5	1.1	8
ø5/32" (ø4)	ø0.098" (ø2.5)	KFG2L0325-00-F	7	8	13.3	5	2.3	1.6	8
ø1/4" (ø6.35)	ø5/32" (ø3.95)	KFG2L0704-00-F	10	12	16.5	6	3.3	6	18
ø5/16" (ø8)	ø0.236" (ø6)	KFG2L0906-00-F	12	14	18.7	6.6	5.3	17	28
ø3/8" (ø9.53)	ø1/4" (ø6.35)	KFG2L1163-00-F	15	17	22.2	7.6	5.6	19	50
ø1/2" (ø12.7)	ø3/8" (ø9.53)	KFG2L1395-00-F	17	19	24.8	8.5	8.5	51	62

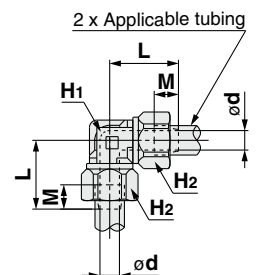

EHEHG
Compliant

Metric M, G
KFG2H□-E

Clean
Design

Metric M, G
KFG2H□-C

FDA
Compliant

Metric M, R, Rc
KQG2-F

Inch UNF, NPT
KQG2-F

Metric G
KQG2-F

Metric M, R, Rc
KQB2-F

Inch UNF, NPT
KQB2-F

Metric G
KQB2-F

Metric R, Rc
KFG2-F

Inch NPT
KFG2-F

Metric G
KFG2-F

Precautions

KFG2-F Series

Applicable Tubing: Inch Size, Connection Thread: NPT

Dimensions

Swivel Elbow: KFG2V



Applicable tubing size [inch]		Connection thread NPT	Model	Width across flats			L1	L2	M	ød	A*1	Effective area [mm ²]	Weight [g]	
O.D.	I.D.			H1	H2	H3								
ø1/8" (ø3.18)	ø0.086" (ø2.18)	1/8	KFG2V0122-N01-F	7	8	12	14.5	16.1	5	1.5	17.3	1	11	
		1/4	KFG2V0122-N02-F			14								19.8
ø5/32" (ø4)	ø0.098" (ø2.5)	1/8	KFG2V0325-N01-F	7	8	12	14.5	16.1	5	1.8	17.3	1.4	11	
		1/4	KFG2V0325-N02-F			14								19.8
ø1/4" (ø6.35)	ø5/32" (ø3.95)	1/8	KFG2V0704-N01-F	10	12	12	16.2	18.3	6	3.3	21.7	5	16	
		1/4	KFG2V0704-N02-F			14								22
ø5/16" (ø8)	ø0.236" (ø6)	1/8	KFG2V0906-N01-F	12	14	12	18.4	19.6	6.6	5.3	24.1	14	23	
		1/4	KFG2V0906-N02-F			14								23.3
		3/8	KFG2V0906-N03-F			19								25.1
ø3/8" (ø9.53)	ø1/4" (ø6.35)	1/4	KFG2V1163-N02-F	15	17	14	21.4	24.7	7.6	5.6	29.7	16	38	
		3/8	KFG2V1163-N03-F			19								26.8
		1/2	KFG2V1163-N04-F			22								30.6
ø1/2" (ø12.7)	ø3/8" (ø9.53)	1/4	KFG2V1395-N02-F	17	19	14	23	25.8	8.5	8.5	31.8	43	46	
		3/8	KFG2V1395-N03-F			19								27.8
		1/2	KFG2V1395-N04-F			22								31.6

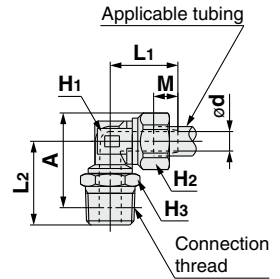

*1 Reference dimensions after installation of NPT thread

Female Connector: KFG2F



Applicable tubing size [inch]		Connection thread NPT	Model	Width across flats		L1	L2	M	ød	Effective area [mm ²]	Weight [g]
O.D.	I.D.			H1	H2						
ø1/8" (ø3.18)	ø0.086" (ø2.18)	1/4	KFG2F0122-N02-F	17	8	26.7	17.2	5	1.5	1.1	25
		1/4	KFG2F0325-N02-F								
ø5/32" (ø4)	ø0.098" (ø2.5)	1/4	KFG2F0704-N02-F	17	12	27.5	16.3	6	3.3	6	28
			1/4								
ø5/16" (ø8)	ø0.236" (ø6)	3/8	KFG2F0906-N03-F	19	14	29.4	17	6.6	5.3	17	32
			3/8								
ø3/8" (ø9.53)	ø1/4" (ø6.35)	3/8	KFG2F1395-N03-F	19	19	31.6	15.6	8.5	8.5	51	42
			3/8								

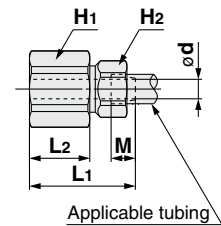

Union Nut: KFG2N



Applicable tubing O.D. [inch]	Model	H (Width across flats)	L	Weight [g]
ø1/8" (ø3.18)	KFG2N-01-F	8	7.8	1.9
ø5/32" (ø4)	KFG2N-03-F	8	7.7	1.9
ø1/4" (ø6.35)	KFG2N-07-F	12	9	4.6
ø5/16" (ø8)	KFG2N-09-F	14	10.1	6.7
ø3/8" (ø9.53)	KFG2N-11-F	17	11.7	10.7
ø1/2" (ø12.7)	KFG2N-13-F	19	12.8	13

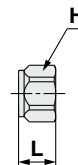

Stainless Steel 316 Insert Fittings

Applicable Tubing: Metric Size, Connection Thread: G*1

KFG2-F Series

*1 ISO 16030 compliant



Applicable Tubing

Tubing material*1, *2	FEP, PFA, Modified PTFE, 2-layer soft fluoropolymer, Nylon, Soft nylon, Polyurethane, Soft polyurethane, Polyolefin, Soft polyolefin, Antistatic soft nylon, Antistatic polyurethane, Hard polyurethane
Tubing size	ø4 x ø2.5, ø4 x ø3, ø6 x ø4, ø8 x ø6, ø10 x ø7.5, ø10 x ø8, ø12 x ø9, ø12 x ø10, ø16 x ø13

*1 Considering the product application, FDA-compliant products are recommended.

*2 For soft polyurethane tubing, hard polyurethane tubing, and antistatic polyurethane tubing, water cannot be used.

Series	Tubing material	Tubing O.D. x I.D. [mm]									
		ø4 x ø2.5	ø4 x ø3	ø6 x ø4	ø8 x ø6	ø10 x ø7.5	ø10 x ø8	ø12 x ø9	ø12 x ø10	ø16 x ø13	
TH	FEP*1	●	—	●	●	●	●	●	●	—	
TL	Super PFA*1	—	●	●	●	—	●	—	●	—	
TLM	PFA*1	●	●	●	●	●	●	●	●	●	
TD	Modified PTFE*1	●	—	●	●	●	—	●	—	—	
TQ	Special fluoropolymer	●	—	●	●	—	●	●	—	—	
T	Nylon	●	●	●	●	●	—	●	—	●	
TS	Soft nylon	●	—	●	●	●	—	●	—	—	
TU	Polyurethane	●	—	●	—	—	—	—	—	—	
TU-X214	Polyurethane*1	●	—	●	—	—	—	—	—	—	
TPH	Polyolefin*1	●	—	●	●	●	—	●	—	—	
TUS	Soft polyurethane	●	—	●	—	—	—	—	—	—	
TUH	Hard polyurethane (High pressure)	●	—	●	—	—	—	—	—	—	
TPS	Soft polyolefin*1	●	—	●	—	—	—	—	—	—	
TAS	Antistatic soft nylon	●	—	●	—	—	—	—	—	—	
TAU	Antistatic polyurethane	●	—	●	—	—	—	—	—	—	

*1 FDA compliant tubing (Refer to page 4.)

Spare Parts

Description	Thread size	Part no.	Material
G thread O-ring	G1/8	KQB2-G01-F	FDA compliant FKM
	G1/4	KQB2-G02-F	
	G3/8	KQB2-G03-F	
	G1/2	KQB2-G04-F	

Specifications

Fluid	Air, Water*1, Steam*3
Operating pressure range*2	-100 kPa to 1 MPa*4
Proof pressure	3.0 MPa
Ambient and fluid temperatures	-5 to 150°C (No freezing)*4
Lubricant	NSF H1 grease
Seal on the threads	O-ring seal

*1 Deionized water is not recommended for use as it may affect the material used in the fittings. In addition, it is known to degrade the water quality.

*2 Do not use the fittings with a leak tester or for vacuum retention because they are not guaranteed for zero leakage.

*3 Please contact SMC for applicable tubing separately.

*4 Check the operating pressure range and operating temperature range of the tubing.

EHDG Compliant
 Metric M, G KFG2H□-E
 Clean Design
 Metric M, G KFG2H□-C
 FDA Compliant
 Metric M, R, Rc KQG2-F
 Inch UNF, NPT KQG2-F
 Metric G KQG2-F
 Metric M, R, Rc KQB2-F
 Inch UNF, NPT KQB2-F
 Metric G KQB2-F
 Metric R, Rc KFG2-F
 Inch NPT KFG2-F
 Metric G KFG2-F
 Precautions

KFG2-F Series

Applicable Tubing: Metric Size, Connection Thread: G

How to Order

Swivel elbow with G thread

KFG2 V 0425 - G 02 - F

Swivel elbow

FDA compliant

Tubing size (Metric)

Symbol	O.D.	I.D.
0425	ø4	ø2.5
0403	ø4	ø3
0604	ø6	ø4
0806	ø8	ø6
1075	ø10	ø7.5
1008	ø10	ø8
1209	ø12	ø9
1210	ø12	ø10
1613	ø16	ø13

Thread size

Symbol	Size
01	G1/8
02	G1/4
03	G3/8
04	G1/2

Thread type

Symbol	Type
G	G

Construction

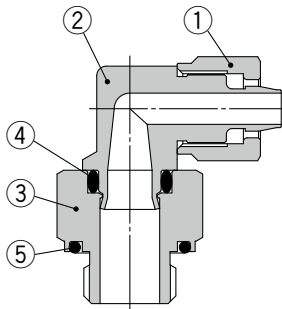

Swivel elbow

Principal Parts Material

No.	Description	Material	Note
1	Union nut	Stainless steel 316	NSF H1 grease
2	Swivel elbow body	Stainless steel 316	NSF H1 grease
3	Stud	Stainless steel 316	
4	O-ring	FDA compliant FKM	NSF H1 grease
5	G thread O-ring	FDA compliant FKM	

Stainless Steel 316 Insert Fittings **KFG2-F Series**

Applicable Tubing: Metric Size, Connection Thread: G

Dimensions

Swivel Elbow: KFG2V



Applicable tubing size [mm]		Connection thread G	Model	Width across flats			L1	L2	M	ød1	ød2	A	Effective area [mm ²]	Weight [g]	
O.D.	I.D.			H1	H2	H3									
ø4	ø2.5	1/8	KFG2V0425-G01-F	7	8	14	19.5	5	1.8	13.8	18.4	1.4	15.5		
		1/4	KFG2V0425-G02-F			19	22.9						33.4		
	ø3	1/8	KFG2V0403-G01-F	14	19.5	2.3	13.8	18.4	2.3	15.5					
		1/4	KFG2V0403-G02-F	19	22.9	17.8	20.8	33.4							
ø6	ø4	1/8	KFG2V0604-G01-F	9	10	14	20.6	5.8	3.3	13.8	20.6	5	18.5		
		1/4	KFG2V0604-G02-F			19	24						17.8	23	36.4
ø8	ø6	1/8	KFG2V0806-G01-F	12	14	14	22.8	6.6	5.3	13.8	25	14	27		
		1/4	KFG2V0806-G02-F			19	26.2						17.8	27.4	44.8
		3/8	KFG2V0806-G03-F			22	28.7						21.8	28.9	64.1
ø10	ø7.5	1/4	KFG2V1075-G02-F	15	17	19	27.9	7.6	6.8	17.8	30.7	25	50.7		
		3/8	KFG2V1075-G03-F			22	30.4						21.8	32.2	68.5
		1/2	KFG2V1075-G04-F			27	34.4						26.5	34.7	108.6
	ø8	3/8	1/4	KFG2V1008-G02-F	19	27.9	7.3	17.8	30.7	49.7					
			3/8	KFG2V1008-G03-F	22	30.4	21.8	32.2	67.5						
			1/2	KFG2V1008-G04-F	27	34.4	26.5	34.7	107.6						
ø12	ø9	1/4	KFG2V1209-G02-F	16	17	19	27.9	8.5	8	17.8	30.7	38	51.7		
		3/8	KFG2V1209-G03-F			22	30.4						21.8	32.2	70.5
		1/2	KFG2V1209-G04-F			27	34.4						26.5	34.7	109.6
	ø10	3/8	1/4	KFG2V1210-G02-F	19	27.9	9	17.8	30.7	53.7					
			3/8	KFG2V1210-G03-F	22	30.4	21.8	32.2	72.5						
			1/2	KFG2V1210-G04-F	27	34.4	26.5	34.7	111.6						
ø16	ø13	3/8	KFG2V1613-G03-F	21	22	22	33.6	9.3	12	21.8	38.2	86	91.7		
		1/2	KFG2V1613-G04-F			27	37.6						26.5	40.7	128.6

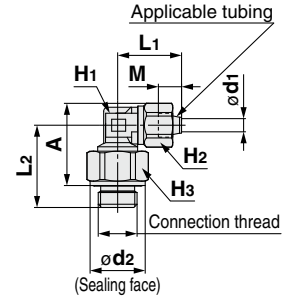

EHEDG Compliant

Metric M, G
KFG2H□-E

Clean Design

Metric M, G
KFG2H□-C

FDA Compliant

Metric M, R, Rc
KQG2-F

Inch UNF, NPT
KQG2-F

Metric G
KQG2-F

Metric M, R, Rc
KQB2-F

Inch UNF, NPT
KQB2-F

Metric G
KQB2-F

Metric R, Rc
KFG2-F

Inch NPT
KFG2-F

Metric G
KFG2-F

Precautions

Specific Product Precautions 1

Be sure to read this before handling the products. Refer to the back cover for safety instructions and pages 75 to 79 for fittings & tubing precautions.



Selection

⚠ Caution

1. Consult with SMC regarding fluids other than air, water and steam.
2. When using the swivel elbow fittings, particles may be generated by rotation for positioning after connecting. If you are concerned about the effects on machinery and equipment, check the particle generation with your machine before use.

Mounting

⚠ Caution

1. The swivel elbow fittings can be rotated for positioning, but they cannot be used rotating.
This will cause metal debris by wearing, which may enter the operating fluid or cause fitting damage.
2. Keep the connection part of fittings and tubes from rotating or oscillating movement.
Failure to do so may cause the fittings to break. In particular, for the swivel elbow, the repeated load from the connection tube may cause the stud to come off.

Piping

⚠ Caution

1. Cut the tubing perpendicularly, being careful not to damage the outside surface.
(Use an SMC tube cutter TK-1, 2, or 3. Do not cut the tubing with pliers, nippers, scissors, etc.)
The tube might be cut diagonally or flattened, making installation impossible or causing problems such as disconnection and leakage.
2. Insert the tube into the union nut with the union nut removed. Grab the tube and gently push it thoroughly into the fitting.

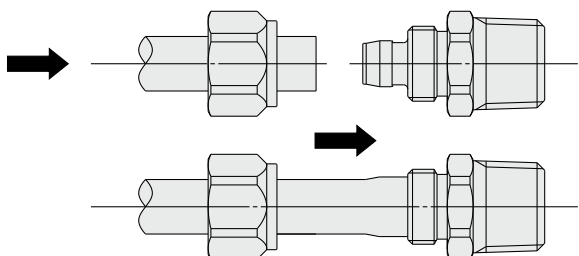

3. After insertion, tighten the union nut temporarily by hand.

Piping

⚠ Caution

4. Fix the body with a tool. Tighten the union nut to the end surface of the body using a suitable wrench.
Hexagon across flats may be deformed, if using an improper wrench for hexagon across flats.
If the body is not secured with a tool, this may cause breakage. (In particular, for the swivel elbow, the stud may come off.)

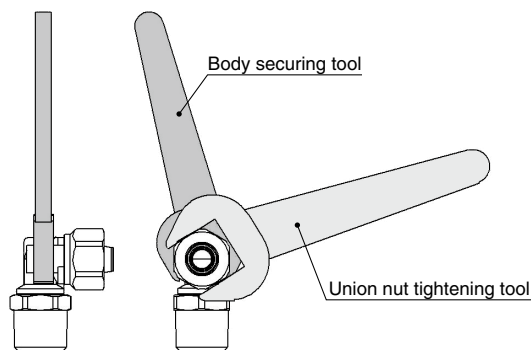

5. Fix the body with a tightening tool. Tighten the union nut to the end surface of the body using a suitable wrench.

Hexagon across flats may be deformed, if using an improper wrench for hexagon across flats. Tighten the union nut with the proper tightening torque shown below.

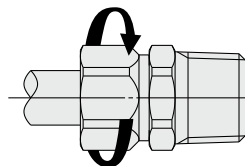

Fitting size	Proper tightening torque [N·m]
KFG2□01	
KFG2□03	2 to 3
KFG2□04	
KFG2□06	3 to 4
KFG2□07	
KFG2□08	5 to 6
KFG2□09	
KFG2□10	8 to 10
KFG2□11	
KFG2□12	10 to 12
KFG2□13	
KFG2□16	16 to 18

Specific Product Precautions 2

Be sure to read this before handling the products. Refer to the back cover for safety instructions and pages 75 to 79 for fittings & tubing precautions.



Cleaning Method

Warning

- 1. Check the connection before cleaning.**
Clean the fitting with the tube connected and the nut tightened. Do not clean the fitting when the tube, union nut, and body are not assembled.
- 2. Review the conditions before cleaning.**
Make sure that the fitting material is not affected or damaged by chemical solution, temperature, and water pressure before use.
- 3. Do not use a metal brush or tool that may damage or scratch the fitting.**

Operating Environment

Caution

- 1. The table below shows material of parts. Please refer to the relevant standards for parts when determining suitability in applications and operating conditions.**

Item	Material	Compliant standards
Cutting parts	Stainless steel	AISI316
MIM parts	Stainless steel	AISI316L equivalent
Rubber parts	Fluoropolymer	FDA 21CFR 177.2600
Grease	Paraffin oil	NSF H1

Maintenance

Caution

- 1. Pre-maintenance inspection**
When the product is removed, turn off the power, cut off the supply pressure, and confirm that fluid in the piping has been discharged.
- 2. During regular maintenance, check for the following and replace any components as necessary.**
 - Scratches, gouges, abrasion, corrosion
 - Leakage
 - Flattening or distortion of the tube
 - Hardening, deterioration or softness of the tube
 - Loosening of the union nut
- 3. Do not repair the fittings or patch the tube for reuse.**
- 4. After operation at a high temperature, leakage may occur due to time dependent change of the tube material. If leakage occurs, remove the tube, cut off the connecting part of the tube, and connect to the piping again.**

Check if the tube dimension accuracy is within the recommended tolerance. If it is difficult to take the tube out of the body, bend the tube to the side to remove.

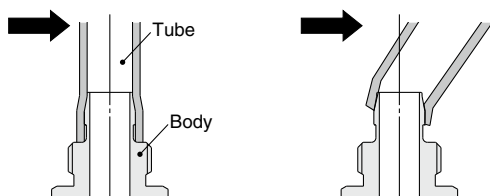

Proper Tightening Torque of Fittings

Caution

- 1. Tighten fittings with sealant using the proper tightening torques in the table below.**
If tightened using a torque exceeding the proper torque level, this may cause the fitting to break.

G Thread Proper Tightening Torque

Connection thread size	Proper tightening torque [N·m]
G1/8	2.9 to 3.2
G1/4	5.7 to 6.3
G3/8	9.5 to 10.5
G1/2	14.3 to 15.8

Stainless steel

Metal exists in nature as ore (like oxide or sulfide). This means that oxide or sulfide is more stable than pure metal. Accordingly, metallic material chemically oxidizes (metallic constituent becomes ion and melts out). It corrodes in the natural environment.

Even though corrosion of metal easily occurs in an environment where oxidizing tendency is stronger, some kinds of metal have a characteristic for which corrosion never happens if the level of oxidizing goes higher than a specific point. In such a case, it is called "metal in passive state".

Stainless steel has corrosion resistance because of a thin coat of passive state on its surface. However, there does not exist stainless steel with absolute corrosion resistance; therefore, many types of stainless steel have been developed for improved corrosion resistance performance.



Fittings & Tubing Precautions 1

Be sure to read this before handling products.

Design / Selection

Warning

1. Confirm the specifications.

Products represented in this catalog are designed only for use in compressed air systems (including vacuum). Do not operate at pressures, temperatures, etc., beyond the range of specifications, as this can cause damage or malfunction. (Refer to the specifications.)

Please contact SMC when using a fluid other than compressed air (including vacuum).

We do not guarantee against any damage if the product is used outside of the specification range.

2. Do not disassemble the product or make any modifications, including additional machining.

Doing so may cause human injury and/or an accident.

3. Check if PTFE can be used in the application.

PTFE powder (Polytetrafluoroethylene resin) is included in the sealant. Confirm that the use of it will not cause any adverse effect on the system.

4. When operating at a high temperature, the fittings and tubing will also become very hot.

Touching the product may result in burns, so be sure to take safety measures before coming into direct contact with the product.

Caution

1. Keep the connection part of fittings and tubing from rotating or oscillating movement. Use rotary One-touch fittings (KS or KX series) in these cases.

The fittings may be damaged if they are used in the above manner.

2. The tubing bending radius in the vicinity of the fitting should be at least the minimum bending radius of the tubing.

If the bending radius is less than the minimum value, fittings may be damaged, and tubing may crack or be crushed. The minimum bending radius of the FR soft nylon tubing (TRS series), FR double layer tubing (TRB series), antistatic soft nylon tubing (TAS series), polyolefin tubing (TPH series), and soft polyolefin tubing (TPS series) is measured as following in accordance with JIS B 8381.

The tubing deformation ratio at the minimum bending radius is obtained through the following formula, based on tubing diameter and mandrel diameter by winding the same radius mandrel tube.

$$\eta = \left(1 - \frac{L - D}{2d}\right) \times 100$$

Here, η : Deformation ratio [%]
d : Tubing diameter [mm]
L : Measured length [mm]
D : Mandrel diameter [mm]
(Twice against the minimum bending radius)
Test temperature: 20 ±5°C
Relative humidity: 65 ±5%

Tube deformation ratio at the minimum bending radius

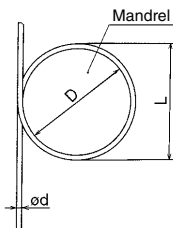

3. Do not use fluids other than those listed on the specifications.

Applicable fluids are air and water. Please consult with SMC if using other fluids.

4. When used with liquid fluid, the fittings or tubing may be damaged depending on the surge pressure.

Design / Selection

Caution

5. Depending on the storage or operating environment and the period of storage or use, the surface of the brass (C3604) may blacken. If the discoloration of the brass is a problem, we recommend selecting electroless nickel-plated brass instead.

Example) KQ2H06-01 NS

6. The dimensions shown in the dimension drawings are merely reference dimensions. The actual dimensions will vary depending on the tolerance. Be sure to provide sufficient clearance around the fitting for piping. Please contact SMC if you are planning to mount the product in a narrow space.

Mounting / Piping

Warning

1. Operation manual

Install the products and operate them only after reading the operation manual carefully and understanding its contents. Also, keep the manual where it can be referred to as necessary.

2. Maintenance space

Allow sufficient space for maintenance and inspection.

3. Adhere to the thread tightening method.

Refer to the "Connection Thread Tightening Method" when mounting the product.

4. There may be cases in which the tubing detaches from the fitting and thrashes around uncontrollably due to tubing degradation or fitting breakage.

To prevent the situation from becoming uncontrollable, fit the tubing with a protective cover or secure it in place.

Caution

1. Preparation before piping

Before piping is connected, it should be thoroughly blown out with air (flushing) or washed to remove chips, cutting oil, and other debris from inside the pipe.

2. Winding of sealant tape

When screwing together pipes, fittings, etc., be certain that chips from the pipe threads and sealant do not get inside the pipe.

Also, if sealant tape is used, leave approx. 1 thread ridge exposed at the end of the threads.

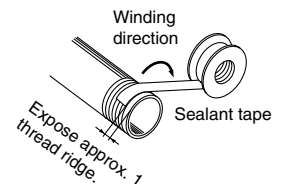

3. Check the model, type, and size before installation. Also, confirm that there are no scratches, gouges, or cracks on the product.

4. When connecting the tubing, take pressure and possible changes to the tubing length into account, and allow a sufficient margin.

Failure to do so may result in fitting breakage or the detachment of the tubing. Refer to the recommended piping conditions.

5. Do not apply unnecessary forces, such as twisting, pulling, moment loads, vibration, impact, etc., on fittings or tubing.

This will cause damage to fittings and will crush, burst, or release tubing.



Fittings & Tubing Precautions 2

Be sure to read this before handling products.

Mounting / Piping

Caution

6. Tubing, with the exception of coiled tubing, requires stationary installation. Do not use standard tubing (non-coiled) in applications where tubing is required to travel inside the flexible protection tube. Tubing that travels may sustain abrasion, extension, or severance due to tensile force. The removal of tubing from the fitting may also occur. Use caution prior to use in an application.
7. To install the fitting, screw the fitting into the hexagonal face of the body, and tighten with a suitable wrench.

Affix the wrench at the base of the thread. If the size of the hexagonal face and wrench do not match, or tightening takes place near the tube side, it may cause the collapse or deformation of the hexagonal face, or damage to the equipment. After installing, confirm that there is no damage to the fitting, etc.

8. Interference in oval type release buttons

The following models cannot be used if a box wrench or socket wrench is used.

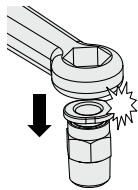

KQ2 Series

Model	Applicable tubing	Connection thread	Part number
Male connector	ø3.2	M3 x 0.5	KQ2H23-M3G1
	ø3.2	M5 x 0.8	KQ2H23-M5□1
	ø4	M3 x 0.5	KQ2H04-M3G1
	ø4	M5 x 0.8	KQ2H04-M5□1
	ø4	M6 x 1.0	KQ2H04-M6□1
	ø6	M5 x 0.8	KQ2H06-M5□1
	ø6	M6 x 1.0	KQ2H06-M6□1
	ø6	R1/8	KQ2H06-01□S1
	ø1/8	10-32UNF	KQ2H01-32□1
	ø5/32	10-32UNF	KQ2H03-32□1
	ø3/16	10-32UNF	KQ2H05-32□1
	ø5/32	NPT1/16	KQ2H03-33□S1
	ø1/8	M5 x 0.8	KQ2H01-M5□1
	ø3/16	M5 x 0.8	KQ2H05-M5□1
ø3/16	R1/8	KQ2H05-01□S1	
Female connector	ø4	M3 x 0.5	KQ2F04-M3□1
	ø4	M5 x 0.8	KQ2F04-M5□1
	ø6	M5 x 0.8	KQ2F06-M5□1
	ø1/8	10-32UNF	KQ2F01-32□1
	ø5/32	10-32UNF	KQ2F03-32□1
	ø1/8	M3 x 0.5	KQ2F23-M3□1
	ø1/8	M5 x 0.8	KQ2F23-M5□1

□: A (Brass), N (Brass + Electroless nickel plating)

KQ2-G Stainless Steel Series

Model	Applicable tubing	Connection thread	Part number
Male connector	ø4	M5 x 0.8	KQ2H04-M5G1
	ø6	M5 x 0.8	KQ2H06-M5G1
	ø6	R1/8	KQ2H06-01GS1

9. When tightening the hexagon socket head male connector, use a suitable hexagon wrench, and connect the piping carefully so as not to deform or damage the inside of the connector. If the inside of the connector is deformed or damaged, the falling out of tubes and other problems may occur.

Air Supply

Warning

1. **Type of fluids**
Please consult with SMC when using the product in applications other than compressed air. Regarding products for general fluids, please contact SMC concerning applicable fluids.
2. **When there is a large amount of drainage**
Compressed air containing a large amount of drainage can cause the malfunction of pneumatic equipment. An air dryer or water separator should be installed upstream from filters.
3. **Drain flushing**
If condensation in the drain bowl is not emptied on a regular basis, the bowl will overflow and allow the condensation to enter the compressed air lines. This causes the malfunction of pneumatic equipment.
If the drain bowl is difficult to check and remove, the installation of a drain bowl with an auto drain option is recommended.
For compressed air quality, refer to the Best Pneumatics No. 6 catalog.
4. **Use clean air.**
Do not use compressed air that contains chemicals, synthetic oils that include organic solvents, salt, corrosive gases, etc., as it can cause damage or malfunction.

Caution

1. **Install an air filter.**
Install an air filter on the upstream side of the valve. Select an air filter with a filtration size of 5 µm or smaller.
2. **Install an aftercooler, air dryer, water separator, etc.**
Compressed air containing a large amount of drainage can cause the malfunction of pneumatic equipment. Therefore, take appropriate measures to ensure air quality, such as by providing an aftercooler, air dryer, or water separator.
3. **Ensure that the fluid and ambient temperatures are within the specified range.**
If the fluid temperature is 5°C or less, the moisture in the circuit could freeze, causing damage to the seals or equipment malfunction. Therefore, take appropriate measures to prevent freezing.

For compressed air quality, refer to the Best Pneumatics No. 6 catalog.

Operating Environment

Warning

1. **Do not use in an atmosphere where corrosive gases, chemicals, sea water, water, or water steam are present. Do not use in cases where there is direct contact with any of the above.**
Refer to each construction drawing for information on the materials of fittings and tubing.
2. **Do not expose the product to direct sunlight for an extended period of time.**
3. **Do not use in a place subject to heavy vibration and/or impact.**
4. **Do not mount the product in locations where it is exposed to radiant heat.**
5. **Do not use ordinary fittings and tubing in locations where static electricity would be problematic.**
This may result in system failure or other problems. In such places, the use of antistatic fittings (KA series) and antistatic tubing (TA series) is recommended.

EHEDG
Compliant

Metric M, G
KFG2H□-E

Clean
Design

Metric M, G
KFG2H□-C

FDA
Compliant

Metric M, R, Rc
KQG2-F

Inch UNF, NPT
KQG2-F

Metric G
KQG2-F

Metric M, R, Rc
KQB2-F

Inch UNF, NPT
KQB2-F

Metric G
KQB2-F

Metric R, Rc
KFG2-F

Inch NPT
KFG2-F

Metric G
KFG2-F

Precautions



Fittings & Tubing Precautions 3

Be sure to read this before handling products.

Operating Environment

Warning

6. Do not use ordinary fittings and tubing in locations where spatter is generated.

Spattering may result in a fire hazard. In such places, the use of flame resistant fittings (KR/KRM series) and flame resistant tubing (TRS/TRB/TRBU/TRTU series) is recommended.

7. Do not use in an environment where the product is directly exposed to cutting oil, lubricant, coolant oil, etc.

Please contact SMC if using in an environment exposed to cutting oil, lubricant, coolant oil, etc.

8. Take caution when nylon tubing and soft nylon tubing are used in a clean room.

The antioxidant on the surface of the tubing may come off, thereby lowering the cleanliness level.

9. Do not use in environments where foreign matter may stick to the product or get mixed in the product's interior.

This may cause leakage or the disconnection of the tubing.

Maintenance

Warning

1. Perform maintenance and inspections according to the procedures indicated in the operation manual.

If handled improperly, malfunction or damage of machinery and equipment may occur.

2. Maintenance work

If handled improperly, compressed air can be dangerous. The assembly, handling, repair, and element replacement of pneumatic systems should be performed by a knowledgeable and experienced person.

3. Drain flushing

Remove drainage from air filters regularly.

4. Removal of equipment and supply/exhaust of compressed air

Before components are removed, first confirm that measures are in place to prevent workpieces from dropping, run-away equipment, etc. Then, cut off the supply pressure and electric power, and exhaust all compressed air from the system using the residual pressure release function.

When the equipment is restarted, proceed with caution after confirming that appropriate measures are in place to prevent sudden movement.

Caution

1. Be certain to wear safety glasses at all times during periodical inspections.

2. Replace fittings or tubing having the following problems.

- 1) Cracks, gouges, wearing, corrosion
- 2) Air leakage
- 3) Twists or crushing of tubing
- 4) Hardening, deterioration, softening of tubing

3. When replacing tubes or fittings, do not try to mend or repair and then reuse them.

One-touch Fittings

Mounting / Piping

Caution

1. Installation and removal of tubing for One-touch fittings

1) Installation of tubing

(1) Cut the tubing perpendicularly, being careful not to damage the outside surface. Use an SMC tube cutter TK-1, 2, 3, 5, or 6. Do not cut the tubing with pliers, nippers, scissors, etc., otherwise the tubing will be deformed and problems may result.

(2) The outside diameter of the polyurethane tubing swells when internal pressure is applied to it. Therefore, it may be impossible to re-insert the tubing into the One-touch fitting. Check the tubing outside diameter, and when the accuracy of the outside diameter is +0.07 mm or larger for $\phi 2$, +0.15 mm or larger for other sizes, re-insert it into the One-touch fitting without cutting the tubing. When the tubing is re-inserted into the One-touch fitting, confirm that the tubing goes through the release button smoothly.

(3) Grasp the tubing, and slowly push it straight (0 to 5°) into the One-touch fitting until it comes to a stop.

(4) Pull the tubing back gently to make sure it has a positive seal. Insufficient installation may cause air to leak or the tubing to release.

As a guide for checking if the tubing is pulled out or not, refer to the following table.

Tubing size	Tensile force of tubing [N]
$\phi 2$, 3.2, 1/8"	5
$\phi 4$, 5/32", 3/16"	8
$\phi 6$, 1/4"	12
$\phi 8$, 5/16"	20
$\phi 10$, 3/8"	30
$\phi 12$, 1/2"	35
$\phi 16$	50

2) Removal of tubing

(1) Push the release button flange evenly and sufficiently to release the tube. Do not push in the tubing before pressing the release button.

(2) Pull out the tubing while keeping the release button depressed. If the release button is not held down sufficiently, the tubing cannot be withdrawn.

(3) To reuse the tubing, remove the previously lodged portion of the tubing. If the lodged portion is left on without being removed, it may result in air leakage and make the removal of the tubing difficult.

2. Connecting products with metal rods

Products with metal rods (KC series, previous KQ series, KN series, KM series, etc.) cannot be connected to KQ2 series One-touch fittings. If connected, the metal rod cannot be retained by the chuck of the One-touch fitting, and products with metal rods may project during pressurization, causing serious personal injury or accident.

Even when products with metal rods can be connected to other One-touch fittings, do not use any tube, resin plug, or reducer after connection. This may cause releasing.

For details about One-touch fittings that can connect to products with metal rods, contact SMC.



Fittings & Tubing Precautions 4

Be sure to read this before handling products.

Connection Thread Tightening Method

1. Connection thread: M3

First, tighten by hand, then use a suitable wrench or hexagon wrench to tighten the hexagonal portion of the body or the hexagon socket portion an additional 1/4 turn.

The reference value for the tightening torque is 0.4 to 0.5 N·m.

2. Connection thread: M5 and 10-32UNF

First, tighten by hand, then use a suitable wrench or hexagon wrench to tighten the hexagonal portion of the body or the hexagon socket portion an additional 1/6 to 1/4 turn.

The reference value for the tightening torque is 1 to 1.5 N·m.

3. Connection thread: M6

First, tighten by hand, then use a suitable wrench or hexagon wrench to tighten the hexagonal portion of the body or the hexagon socket portion an additional 1/6 to 1/4 turn.

* Excessive tightening may damage the thread portion or deform the gasket and cause air leakage.

Insufficient tightening may loosen the threads or cause air leakage.

4. Fittings with sealant: R, NPT

1) First, tighten the fitting by hand, then use a suitable wrench or hexagon wrench to tighten the hexagonal portion of the body or the hexagon socket portion a further 2 or 3 turns.

To find the appropriate tightening torque, see the table below.

Connection thread size (R, NPT)	Tightening torque [N·m]
1/16, 1/8	3 to 5
1/4	8 to 12
3/8	15 to 20
1/2	20 to 25

2) If the fitting is tightened with excessive torque, a large amount of sealant will seep out. Remove the excess sealant.

3) Insufficient tightening may cause seal failure or loosen the threads.

4) For reuse

(1) Normally, fittings with a sealant can be reused up to 2 to 3 times.

(2) To prevent air leakage through the sealant, remove any loose sealant stuck to the fitting by blowing air over the threaded portion.

(3) If the sealant no longer provides effective sealing, wind sealant tape over the sealant before reusing. Do not use any form other than the tape type of sealant.

(4) Once the fitting has been tightened, backing it out to its original position often causes the sealant to become defective. Air leakage will occur.

5. Face seal fittings: R, NPT, G

1) Tighten fittings with sealant using the proper tightening torques in the table below.

Connection thread size (R, NPT, G)	Proper tightening torque [N·m]
1/16, 1/8	3 to 5
1/4	8 to 12
3/8	15 to 20
1/2	20 to 25

2) Insufficient tightening may cause seal failure or loosen the threads.

3) For reuse

(1) Normally, fittings with a sealant can be reused up to 6 to 10 times.

(2) The seal ring cannot be replaced.

6. Uni thread fittings

1) First, tighten the threaded portion by hand, then use a suitable wrench or hexagon wrench to tighten the hexagonal portion of the body or the hexagon socket portion further at the appropriate wrench tightening angle shown below. For the reference value for the tightening torque, refer to the table below.

Connection Female Thread: Rc, NPT, NPTF

Uni thread size	Wrench tightening angle after hand-tightening [deg]	Tightening torque [N·m]
1/8	30 to 60	3 to 5
1/4	30 to 60	8 to 12
3/8	15 to 45	14 to 16
1/2	15 to 30	20 to 22

Connection Female Thread: G

Uni thread size	Wrench tightening angle after hand-tightening [deg]	Tightening torque [N·m]
1/8	30 to 45	3 to 4
1/4	15 to 30	4 to 5
3/8	15 to 30	8 to 9
1/2	15 to 30	14 to 15

2) The gasket can be reused up to 6 to 10 times. It can be replaced easily when it has sustained damage. A broken gasket can be removed by holding it and then turning it in the same direction as loosening the thread. If the gasket is difficult to remove, cut it with nippers, etc. In such a case, use caution not to scratch the seat face because the seat face of the fitting's 45° gasket is the sealing face.

Chamfer Dimensions for Female Threads

Caution

1. Chamfer dimensions for female connection threads M3, M5, 10-32UNF

In compliance with ISO 16030 Standards (air pressure fluid dynamics – connection – ports and stud ends), the chamfer dimensions shown below are recommended. By chamfering as shown in the following table, machining of threads is easier and effective for burr prevention.

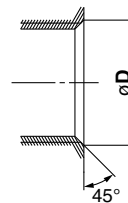

Connection thread size	Chamfer dimension øD (Recommended value) [mm]
M3	3.1 to 3.4
M5	5.1 to 5.4
10-32UNF	5.0 to 5.3

2. Chamfer dimensions of R and NPT threads with sealant, and Uni threads

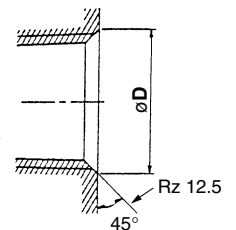

Connection thread size	Chamfer dimension øD (Recommended value)		
	G	Rc	NPT, NPTF
1/16	—	—	8.2 to 8.4
1/8	10.2 to 10.6	10.2 to 10.4	10.5 to 10.7
1/4	13.6 to 14.0	13.6 to 13.8	14.1 to 14.3
3/8	17.1 to 17.5	17.1 to 17.3	17.4 to 17.6
1/2	21.4 to 21.8	21.4 to 21.6	21.7 to 21.9

* For Uni threads, Rz 12.5 is necessary for sealing at the chamfered part.



Fittings & Tubing Precautions 5

Be sure to read this before handling products.

Chamfer Dimensions for Female Threads

⚠ Caution

3. Chamfer dimensions for female threads of face seal fittings (R, NPT, G)

- 1) Surface roughness of bearing surface: Rz 25 or less
- 2) Chamfer dimension: $\phi D1$, Seal bearing surface diameter: $\phi D2$ (Refer to the table below.)
- 3) Female thread inclination angle: 1° or less
- 4) Counterbore diameter when the female thread is counterbored: $\phi D3$
 - Models with hexagonal flats: Body width across flats x 1.1 or more
 - Models other than hexagon (Hexagon socket head male connector, etc.): Body dimensions + 0.2 mm or more
 - * The width across flats and the body dimensions differ depending on the model even when the same thread size is used. Refer to the dimensions in the catalog.
- 5) If oil content or sealant is sticking to the female thread, this may cause damage to the product. Remove it before piping.

Connection thread size	Chamfer dimension $\phi D1$ [mm]	Seal bearing surface diameter $\phi D2$ [mm]
R1/8	10.2 to 10.4	12 or more
R1/4	13.6 to 13.8	17 or more
R3/8	17.1 to 17.3	21 or more
R1/2	21.4 to 21.6	27 or more
NPT1/16	8.2 to 8.4	11.11 or more
NPT1/8	10.5 to 10.7	12.7 or more
NPT1/4	14.1 to 14.3	17.46 or more
NPT3/8	17.4 to 17.6	22 or more
NPT1/2	21.7 to 21.9	28.7 or more
G1/8	10.2 to 10.6	12 or more
G1/4	13.6 to 14.0	17 or more
G3/8	17.1 to 17.5	21 or more
G1/2	21.4 to 21.8	27 or more

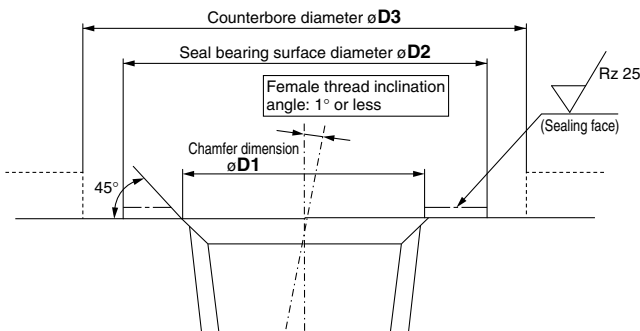

Recommended Piping Conditions

1. When connecting piping to the One-touch fitting, use a pipe length with sufficient margin, in accordance with the piping conditions shown in Fig. 1.

Also, when using a tying band, etc., to bind the piping together, make sure that external force does not come to bear on the fitting. (See Fig. 2.)

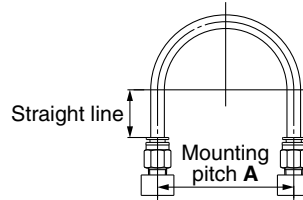

Fig. 1 Recommended piping

Unit: [mm]

Tubing size	Mounting pitch A			Straight line length
	Nylon tubing	Soft nylon tubing	Polyurethane tubing	
$\phi 2$	—	—	13 or more	10 or more
$\phi 3.2, 1/8"$	44 or more	35 or more	25 or more	16 or more
$\phi 4, 5/32"$	56 or more	44 or more	26 or more	20 or more
$\phi 3/16"$	67 or more	52 or more	38 or more	24 or more
$\phi 6$	84 or more	66 or more	39 or more	30 or more
$\phi 1/4"$	89 or more	70 or more	57 or more	32 or more
$\phi 8, 5/16"$	112 or more	88 or more	52 or more	40 or more
$\phi 10$	140 or more	110 or more	69 or more	50 or more
$\phi 3/8"$	134 or more	105 or more	69 or more	48 or more
$\phi 12$	168 or more	132 or more	88 or more	60 or more
$\phi 1/2"$	178 or more	140 or more	93 or more	64 or more
$\phi 16$	224 or more	176 or more	114 or more	80 or more

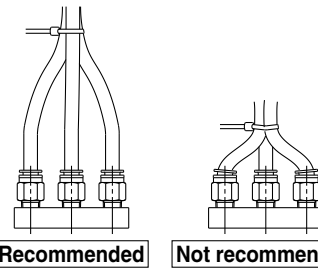

Fig. 2 When using a tying band to bind the piping together

Tubing Design / Selection

⚠ Caution

1. When using tubing from a manufacturer other than SMC, be careful of the tolerance of the tubing O.D. and tubing material.

- 1) Nylon tubing Within ± 0.1 mm
- 2) Soft nylon tubing Within ± 0.1 mm
- 3) Polyurethane tubing Within $+0.15$ mm, Within -0.2 mm

Do not use tubing which does not satisfy the specified tubing O.D. accuracy, or tubing with an I.D., material, hardness, or surface roughness that differs from SMC's tubing. Please consult SMC if anything is unclear. It may cause difficulty in connecting the tubing, leakage, disconnection of the tubing, or fitting damage.

When used with tubing other than those from SMC, due to their properties, the products listed below are not subject to warranty.

KQG2, KQB2, KFG2, KF, $\phi 2$ MM

2. When using fittings other than those from SMC, be certain to confirm that the operating conditions are such that no problems will arise.

Safety Instructions

These safety instructions are intended to prevent hazardous situations and/or equipment damage. These instructions indicate the level of potential hazard with the labels of “**Caution**,” “**Warning**” or “**Danger**.” They are all important notes for safety and must be followed in addition to International Standards (ISO/IEC)*1), and other safety regulations.

 **Caution:** **Caution** indicates a hazard with a low level of risk which, if not avoided, could result in minor or moderate injury.

 **Warning:** **Warning** indicates a hazard with a medium level of risk which, if not avoided, could result in death or serious injury.

 **Danger:** **Danger** indicates a hazard with a high level of risk which, if not avoided, will result in death or serious injury.

*1) ISO 4414: Pneumatic fluid power – General rules relating to systems.
ISO 4413: Hydraulic fluid power – General rules relating to systems.
IEC 60204-1: Safety of machinery – Electrical equipment of machines.
(Part 1: General requirements)
ISO 10218-1: Manipulating industrial robots – Safety.
etc.

Warning

1. The compatibility of the product is the responsibility of the person who designs the equipment or decides its specifications.

Since the product specified here is used under various operating conditions, its compatibility with specific equipment must be decided by the person who designs the equipment or decides its specifications based on necessary analysis and test results. The expected performance and safety assurance of the equipment will be the responsibility of the person who has determined its compatibility with the product. This person should also continuously review all specifications of the product referring to its latest catalog information, with a view to giving due consideration to any possibility of equipment failure when configuring the equipment.

2. Only personnel with appropriate training should operate machinery and equipment.

The product specified here may become unsafe if handled incorrectly. The assembly, operation and maintenance of machines or equipment including our products must be performed by an operator who is appropriately trained and experienced.

3. Do not service or attempt to remove product and machinery/equipment until safety is confirmed.

1. The inspection and maintenance of machinery/equipment should only be performed after measures to prevent falling or runaway of the driven objects have been confirmed.
2. When the product is to be removed, confirm that the safety measures as mentioned above are implemented and the power from any appropriate source is cut, and read and understand the specific product precautions of all relevant products carefully.
3. Before machinery/equipment is restarted, take measures to prevent unexpected operation and malfunction.

4. Contact SMC beforehand and take special consideration of safety measures if the product is to be used in any of the following conditions.

1. Conditions and environments outside of the given specifications, or use outdoors or in a place exposed to direct sunlight.
2. Installation on equipment in conjunction with atomic energy, railways, air navigation, space, shipping, vehicles, military, medical treatment, combustion and recreation, or equipment in contact with food and beverages, emergency stop circuits, clutch and brake circuits in press applications, safety equipment or other applications unsuitable for the standard specifications described in the product catalog.
3. An application which could have negative effects on people, property, or animals requiring special safety analysis.
4. Use in an interlock circuit, which requires the provision of double interlock for possible failure by using a mechanical protective function, and periodical checks to confirm proper operation.

Caution

1. The product is provided for use in manufacturing industries.

The product herein described is basically provided for peaceful use in manufacturing industries.
If considering using the product in other industries, consult SMC beforehand and exchange specifications or a contract if necessary.
If anything is unclear, contact your nearest sales branch.

Limited warranty and Disclaimer/ Compliance Requirements

The product used is subject to the following “Limited warranty and Disclaimer” and “Compliance Requirements”.

Read and accept them before using the product.

Limited warranty and Disclaimer

1. The warranty period of the product is 1 year in service or 1.5 years after the product is delivered, whichever is first.*2)
Also, the product may have specified durability, running distance or replacement parts. Please consult your nearest sales branch.
2. For any failure or damage reported within the warranty period which is clearly our responsibility, a replacement product or necessary parts will be provided.
This limited warranty applies only to our product independently, and not to any other damage incurred due to the failure of the product.
3. Prior to using SMC products, please read and understand the warranty terms and disclaimers noted in the specified catalog for the particular products.

*2) Vacuum pads are excluded from this 1 year warranty.

A vacuum pad is a consumable part, so it is warranted for a year after it is delivered.
Also, even within the warranty period, the wear of a product due to the use of the vacuum pad or failure due to the deterioration of rubber material are not covered by the limited warranty.

Compliance Requirements

1. The use of SMC products with production equipment for the manufacture of weapons of mass destruction (WMD) or any other weapon is strictly prohibited.
2. The exports of SMC products or technology from one country to another are governed by the relevant security laws and regulations of the countries involved in the transaction. Prior to the shipment of a SMC product to another country, assure that all local rules governing that export are known and followed.

Caution

SMC products are not intended for use as instruments for legal metrology.

Measurement instruments that SMC manufactures or sells have not been qualified by type approval tests relevant to the metrology (measurement) laws of each country. Therefore, SMC products cannot be used for business or certification ordained by the metrology (measurement) laws of each country.

Safety Instructions

Be sure to read the “Handling Precautions for SMC Products” (M-E03-3) and “Operation Manual” before use.