

New Release

Dust-tight/Water-jet-proof (IP65 Equivalent/IP67 Equivalent)

Electric Actuator/Rod Type

Enclosure: IP65 equivalent/IP67 equivalent

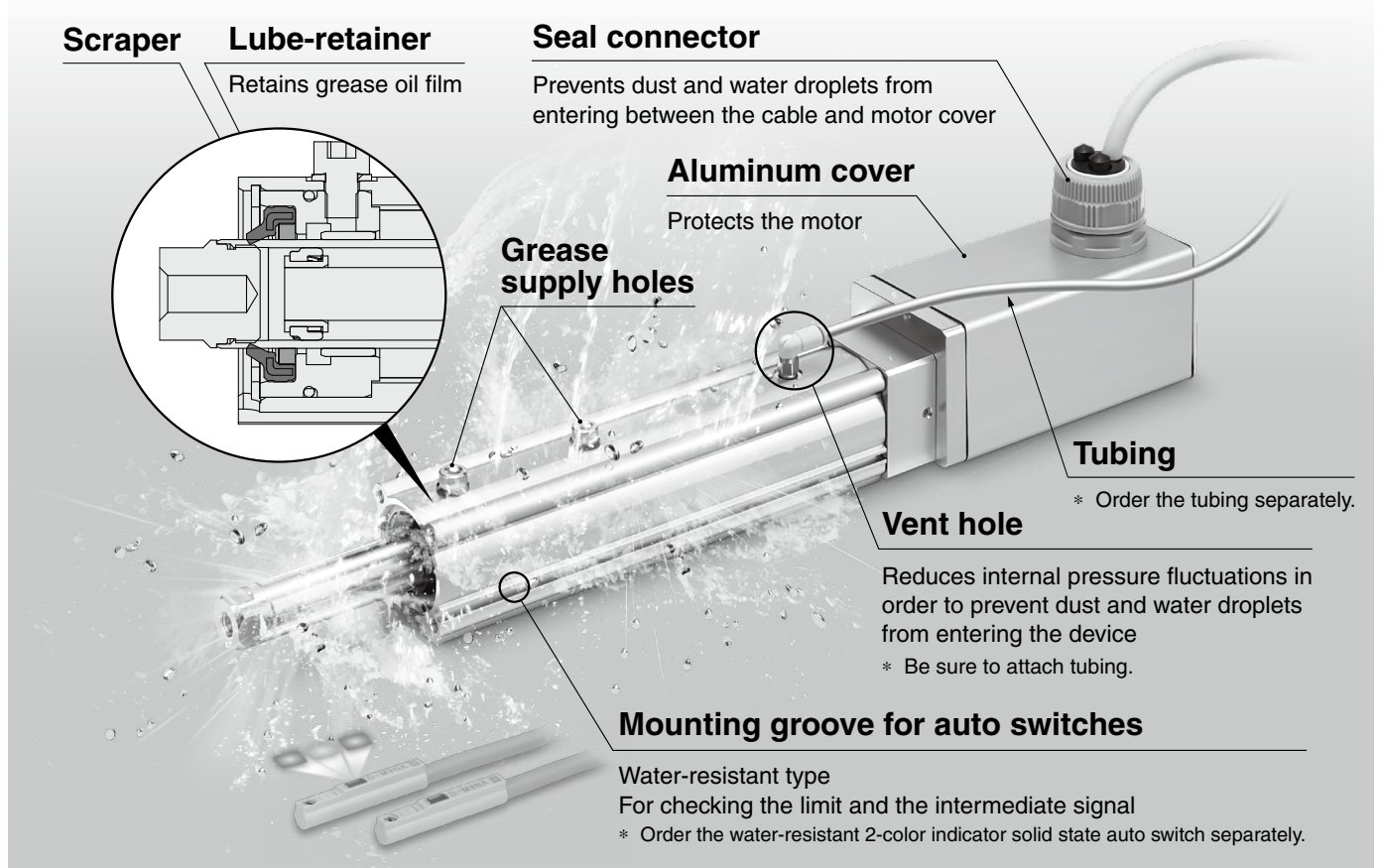

Max. stroke: 500 mm*1
*1 For sizes 32 and 40

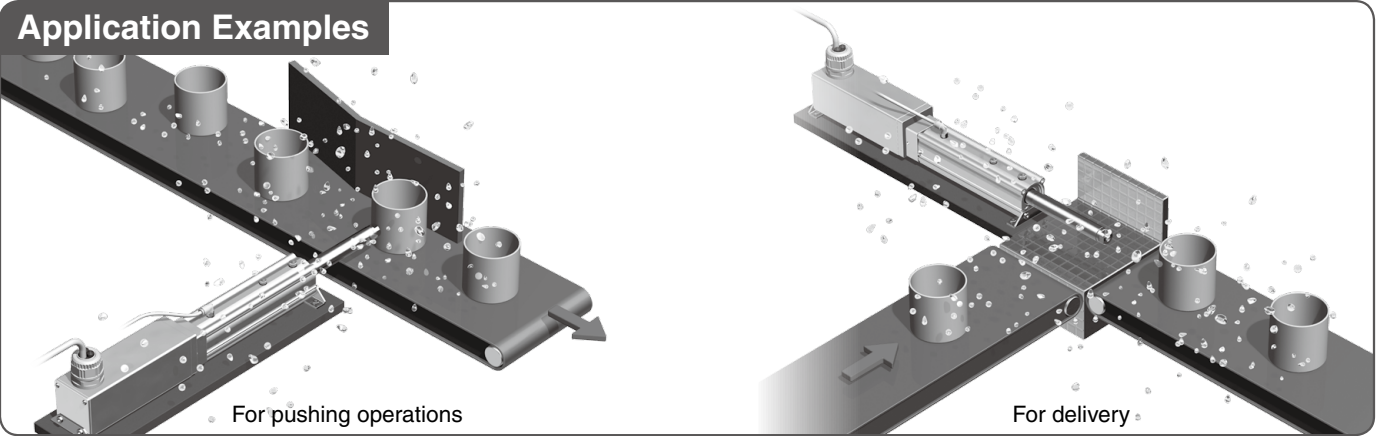

LEY-X7 Series



Electric Actuator/Rod Type

LEY-X7 Series Dust-tight/Water-jet-proof (IP65 Equivalent/IP67 Equivalent)

Model Selection

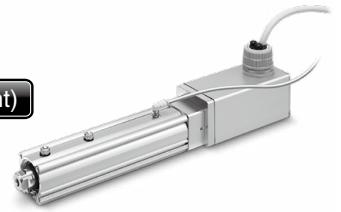

LEY-X7 Series ▶ p. 7

Refer to page 2 for the LECPA, JXC□₂ and page 3 for the LECA6.

Speed-Work Load Graph (Guide) For Step Motor (Servo/24 VDC) JXC□1, LECP1

Horizontal

LEY25□-X7 for acceleration/deceleration: 2000 mm/s²

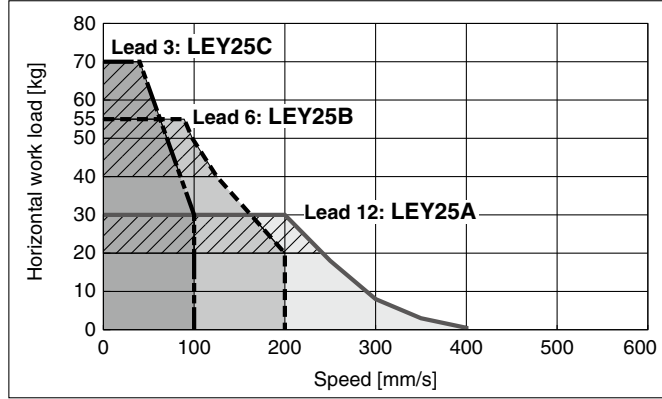

LEY32□-X7 for acceleration/deceleration: 2000 mm/s²

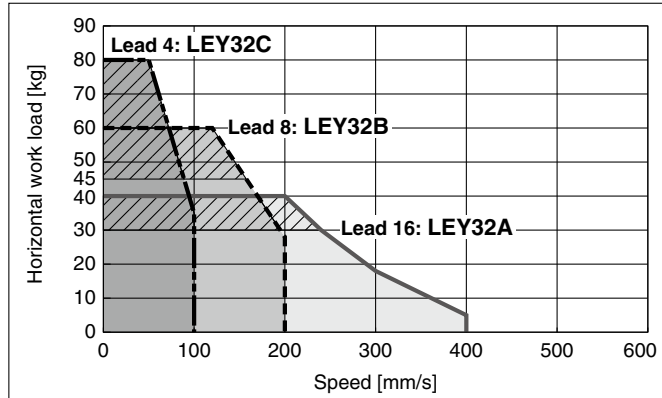

LEY40□-X7 for acceleration/deceleration: 2000 mm/s²

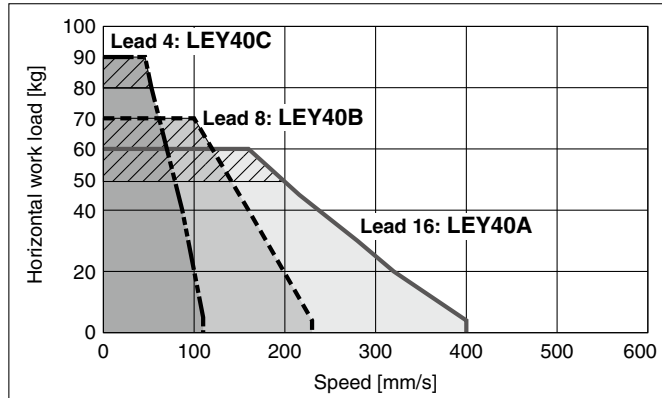

Vertical

LEY25□-X7

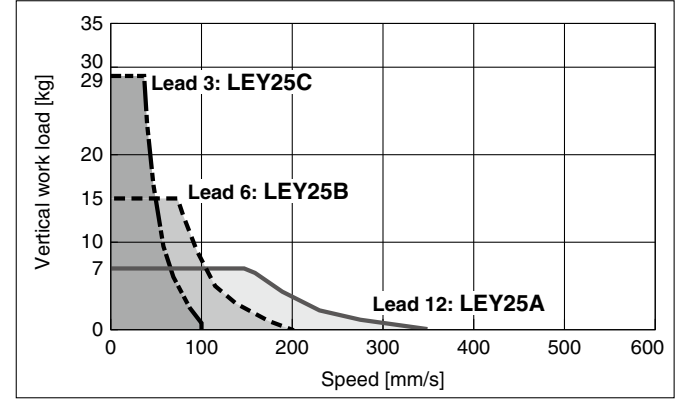

LEY32□-X7

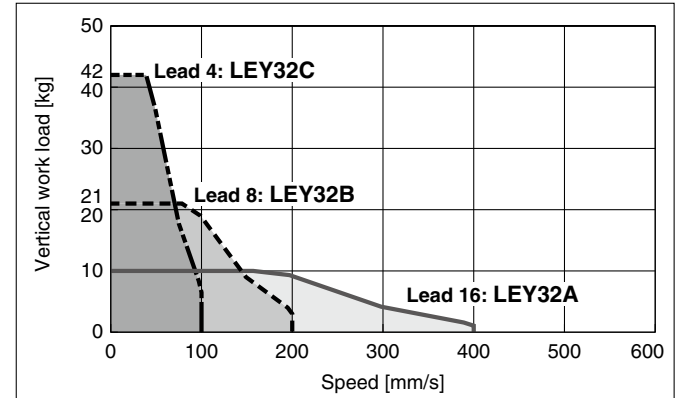

LEY40□-X7

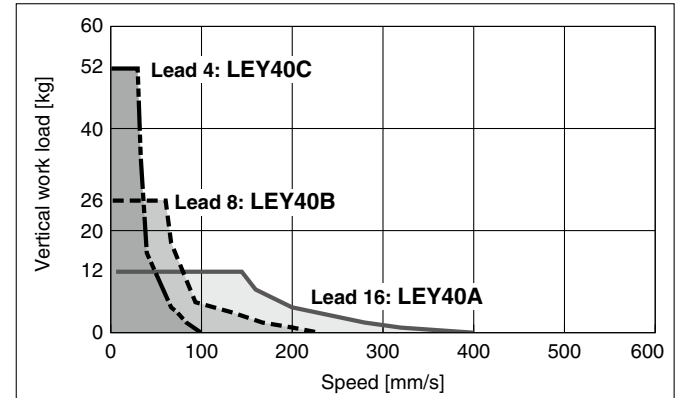

Refer to page 1 for the JXC□1, LECPC1 and page 3 for the LECA6.

Speed-Work Load Graph (Guide) For Step Motor (Servo/24 VDC) LECPA, JXC□₃

Horizontal

LEY25□-X7

▨ for acceleration/deceleration: 2000 mm/s²

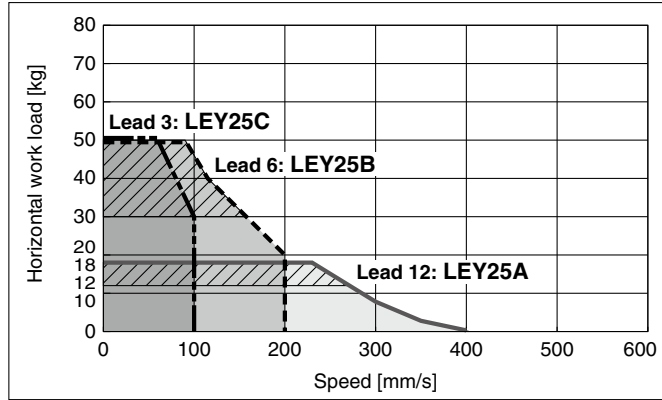

LEY32□-X7

▨ for acceleration/deceleration: 2000 mm/s²

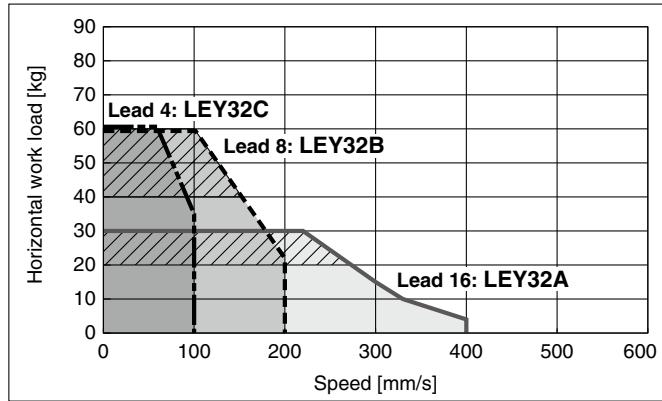

LEY40□-X7

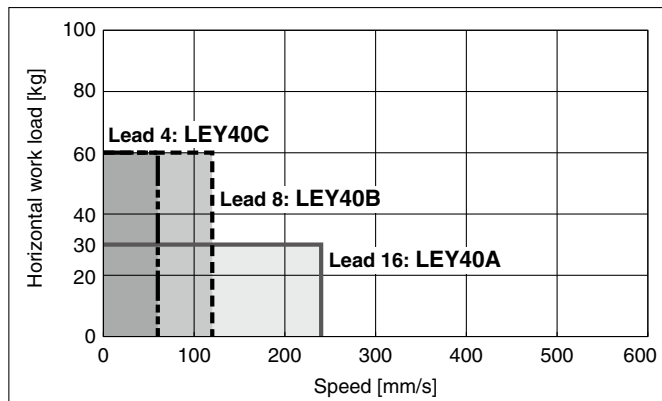

Vertical

LEY25□-X7

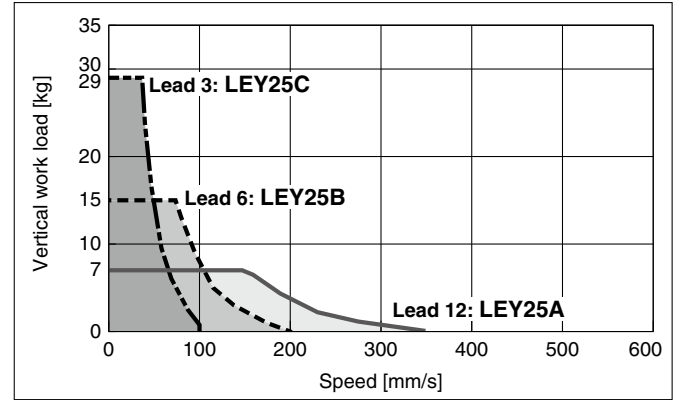

LEY32□-X7

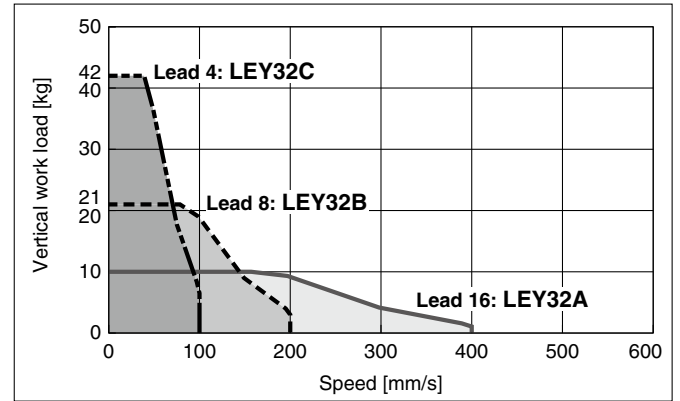

LEY40□-X7

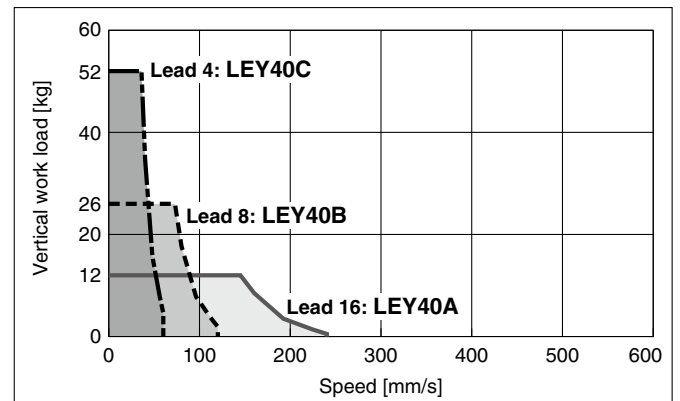

LEY-X7 Series

Step Motor (Servo/24 VDC)

Servo Motor (24 VDC)

Dust-tight/Water-jet-proof (IP65 Equivalent/IP67 Equivalent)

Refer to page 1 for the JXC□1, LEC□1 and page 2 for the LEC□A, JXC□2, JXC□3.

Speed-Work Load Graph (Guide) For Servo Motor (24 VDC) LECA6

Horizontal

LEY25□A-X7

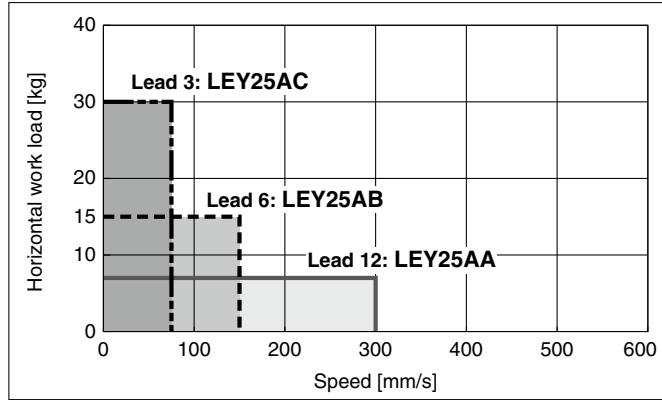

Vertical

LEY25□A-X7

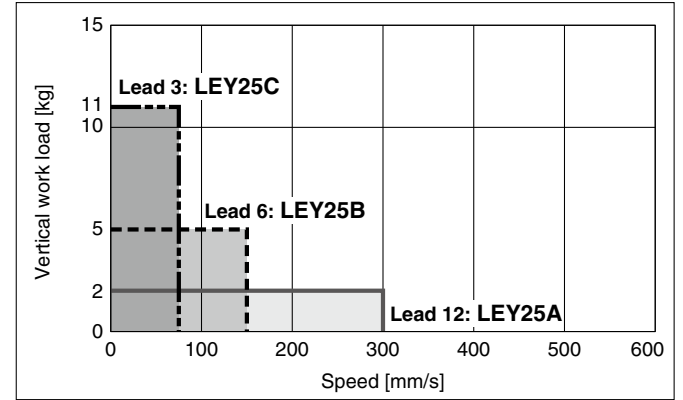

Force Conversion Graph

Step Motor (Servo/24 VDC)

LEY25□-X7

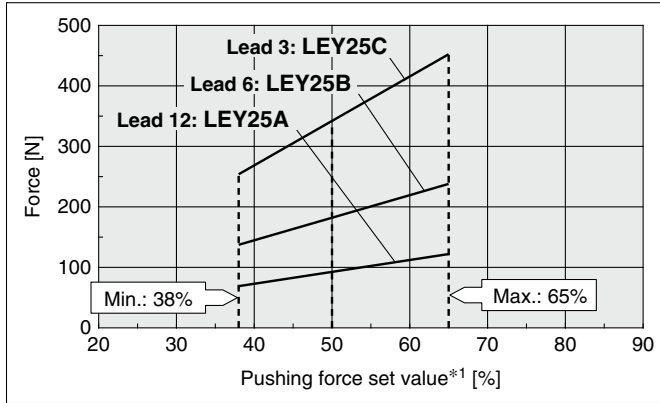

Ambient temperature	Pushing force set value*1 [%]	Duty ratio [%]	Continuous pushing time [min]
40°C or less	65 or less	100	—

LEY32□-X7

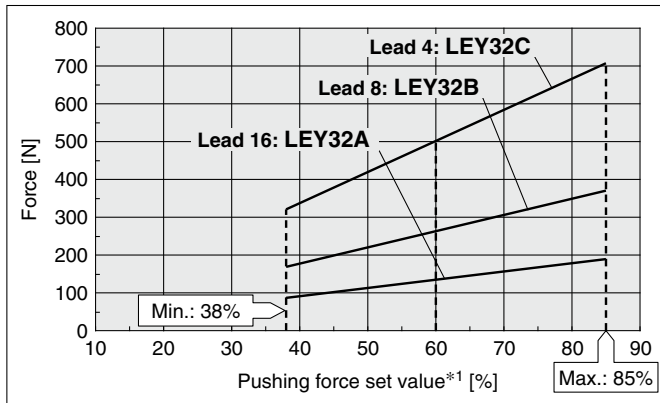

Ambient temperature	Pushing force set value*1 [%]	Duty ratio [%]	Continuous pushing time [min]
25°C or less	85 or less	100	—
40°C	65 or less	100	—
	85	50	15

LEY40□-X7

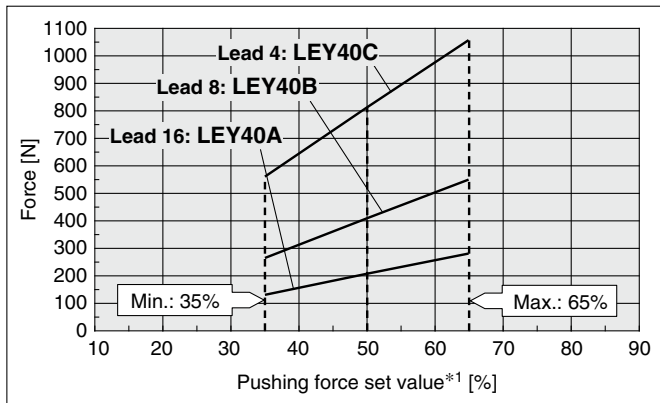

Ambient temperature	Pushing force set value*1 [%]	Duty ratio [%]	Continuous pushing time [min]
40°C or less	65 or less	100	—

Servo Motor (24 VDC)

LEY25□A-X7

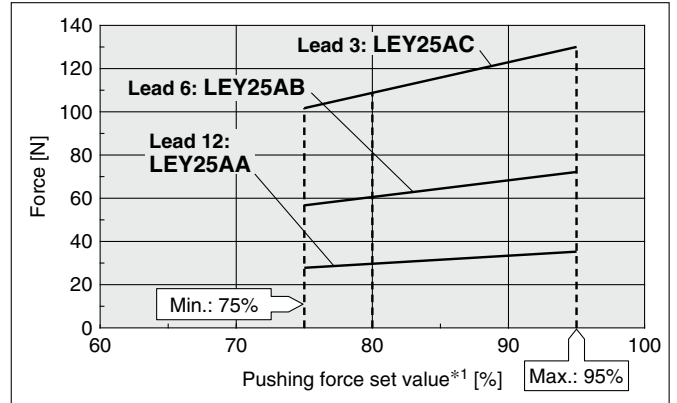

Ambient temperature	Pushing force set value*1 [%]	Duty ratio [%]	Continuous pushing time [min]
40°C or less	95 or less	100	—

<Limit Values for Pushing Force and Trigger Level in Relation to Pushing Speed> Without Load

Model	Lead	Pushing speed [mm/s]	Pushing force (Setting input value)	Model	Lead	Pushing speed [mm/s]	Pushing force (Setting input value)
LEY25	A/B/C	21 to 35	50 to 65%	LEY25□A	A/B/C	21 to 35	80 to 95%
	A	24 to 30	60 to 85%				
LEY32	B/C	21 to 30	60 to 85%				
	A	24 to 30	50 to 65%				
LEY40	B/C	21 to 30	50 to 65%				
	A	24 to 30	50 to 65%				

There is a limit to the pushing force in relation to the pushing speed. If the product is operated outside of the range (low pushing force), the completion signal [INP] may be output before the pushing operation has been completed (during the moving operation). If operating with the pushing speed below the min. speed, please check for operating problems before using the product.

<Set Values for Vertical Upward Transfer Pushing Operations>

For vertical loads (upward), set the pushing force to the max. value shown below and operate at the work load or less.

Model	LEY25□			LEY32□			LEY40□			LEY25□A		
	A	B	C	A	B	C	A	B	C	A	B	C
Work load [kg]	2.5	5	10	4.5	9	18	7	14	28	1.2	2.5	5
Pushing force	65%			85%			65%			95%		

*1 Set values for the controller.

LEY-X7 Series

Step Motor (Servo/24 VDC)

Servo Motor (24 VDC)

Dust-tight/Water-jet-proof (IP65 Equivalent/IP67 Equivalent)

Graph of Allowable Lateral Load on the Rod End (Guide)

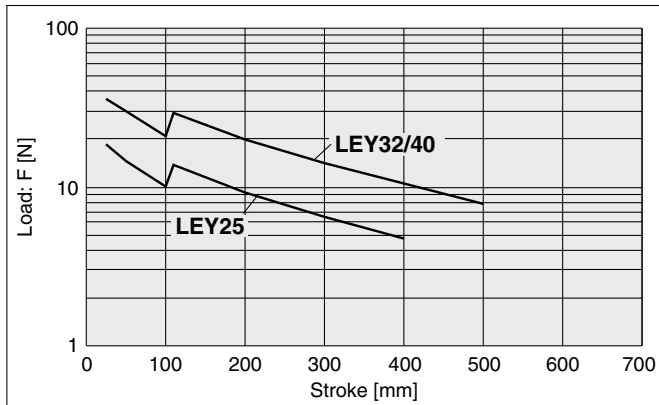

[Stroke] = [Product stroke] + [Distance from the rod end to the center of gravity of the workpiece]

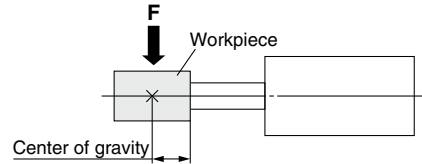

Rod Displacement: δ [mm]

Stroke \ Size	30	50	100	150	200	250	300	350	400	450	500
25	±0.3	±0.4	±0.7	±0.7	±0.9	±1.1	±1.3	±1.5	±1.7	—	—
32/40	±0.3	±0.4	±0.7	±0.6	±0.8	±1.0	±1.1	±1.3	±1.5	±1.7	±1.8

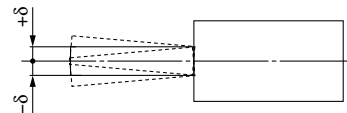

Non-rotating Accuracy of Rod

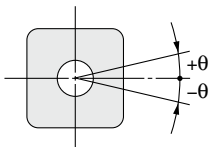

Size	Non-rotating accuracy θ
25	±0.8°
32/40	±0.7°

* Avoid using the electric actuator in such a way that rotational torque would be applied to the piston rod.

This may cause the deformation of the non-rotating guide, abnormal auto switch responses, play in the internal guide, or an increase in the sliding resistance.

LEY-X7 Series Enclosure

Degrees of Protection

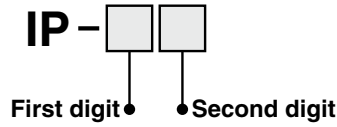

First Digit: Degree of protection against solid foreign objects

0	Not protected
1	Protected against solid foreign objects of 50 mmø and larger
2	Protected against solid foreign objects of 12 mmø and larger
3	Protected against solid foreign objects of 2.5 mmø and larger
4	Protected against solid foreign objects of 1.0 mmø and larger
5	Dust protected
6	Dust-tight

Second Digit: Degree of protection against water

0	Not protected	—
1	Protected against vertically falling water droplets	Drip-proof type 1
2	Protected against vertically falling water droplets when enclosure is tilted up to 15°	Drip-proof type 2
3	Protected against rainfall when enclosure is tilted up to 60°	Rain-proof type
4	Protected against splashing water	Splash-proof type
5	Protected against water jets	Water-jet-proof type
6	Protected against powerful water jets	Powerful water-jet-proof type
7	Protected against the effects of temporary immersion in water	Immersion type
8	Protected against the effects of continuous immersion in water	Submersible type

Example) Degrees of protection

Degrees of protection			Details
IP65	Solid foreign objects	Dust-tight	Dust particles are prevented from entering the device.
	Entry of water	Water-jet-proof*1	The direct application of water jets to the device from any direction will not cause any damage.
IP67	Solid foreign objects	Dust-tight	Dust particles are prevented from entering the device.
	Entry of water	Immersion*1	The amount of water that enters the device when the actuator (in the stopped state) is submerged in up to 1 m of water for up to 30 mins will not cause any damage.

*1 Be sure to take appropriate protective measures if the product is to be used in an environment where it will be constantly exposed to water or fluids other than water splash. In particular, the product cannot be used in environments where oils, such as cutting oil or cutting fluid, are present.

Electric Actuator/Rod Type **LEY-X7 Series**

Step Motor (Servo/24 VDC)

Servo Motor (24 VDC)

Dust-tight/Water-jet-proof (IP65 Equivalent/IP67 Equivalent)

JXC Series (For details, refer to page 9.)

10 Controller

Nil	Without controller
C□1□□	With controller

C D 1 7 T

Interface

(Communication protocol/Input/Output)

E	EtherCAT®
9	EtherNet/IP™
P	PROFINET
D	DeviceNet™
L	IO-Link
M	CC-Link Ver 1.10
5	Parallel input (NPN)
6	Parallel input (PNP)

Mounting

7	Screw mounting
8*10	DIN rail

For single axis

Communication plug connector I/O cable*11

Symbol	Type	Applicable interface
Nil	Without accessory	—
S	Straight type communication plug connector	DeviceNet™
T	T-branch type communication plug connector	CC-Link Ver 1.10
1	I/O cable (1.5 m)	Parallel input (NPN) Parallel input (PNP)
3	I/O cable (3 m)	
5	I/O cable (5 m)	



LEC Series (For details, refer to page 9.)

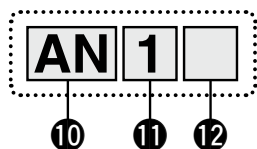

10 Controller/Driver type*6

Nil	Without controller/driver	
6N	LECA6	NPN
6P	(Step data input type)	PNP
1N	LECP1	NPN
1P	(Programless type)	PNP
AN	LECPA*7	NPN
AP	(Pulse input type)	PNP

11 I/O cable length*8, Communication plug

Nil	Without cable
1	1.5 m
3	3 m*9
5	5 m*9

12 Controller/Driver mounting

Nil	Screw mounting
D	DIN rail*10



- *1 Please consult with SMC for non-standard strokes as they are produced as special orders.
- *2 The mounting bracket is shipped together with the product but does not come assembled.
- *3 For the horizontal cantilever mounting of the rod flange or ends tapped types, use the actuator within the following stroke range.
· LEY25: 200 mm or less · LEY32/40: 100 mm or less
- *4 The head flange type is not available for the LEY32/40.
- *5 Produced upon receipt of order (Robotic cable only)
- *6 For details on controllers/drivers and compatible motors, refer to the compatible controller/driver on the next page.
- *7 When pulse signals are open collector, order the current limiting resistor (LEC-PA-R-□) separately after referring to the **Web Catalog**.

- *8 When "Without controller/driver" is selected for controller/driver types, I/O cable cannot be selected. If an I/O cable is required, refer to the **Web Catalog** of the controller/driver it is to be used with. (Cable for the LECA6, LECP1, or LECPA)
- *9 When "Pulse input type" is selected for controller/driver types, pulse input usable only with differential. Only 1.5 m cables usable with open collector
- *10 The DIN rail is not included. Order it separately.
- *11 Select "Nil" for anything other than DeviceNet™, CC-Link, or parallel input.
Select "Nil," "S," or "T" for DeviceNet™ or CC-Link.
Select "Nil," "1," "3," or "5" for parallel input.

⚠ Caution

[CE-compliant products]

- ① EMC compliance was tested by combining the electric actuator LEY series and the controller LEC/JXC series.
The EMC depends on the configuration of the customer's control panel and the relationship with other electrical equipment and wiring. Therefore, compliance with the EMC directive cannot be certified for SMC components incorporated into the customer's equipment under actual operating conditions. As a result, it is necessary for the customer to verify compliance with the EMC directive for the machinery and equipment as a whole.
- ② For the servo motor (24 VDC) specification, EMC compliance was tested by installing a noise filter set (LEC-NFA). Refer to the **Web Catalog** for the noise filter set. Refer to the LECA series Operation Manual for installation.

The actuator and controller/driver are sold as a package.

Confirm that the combination of the controller/driver and actuator is correct.

<Check the following before use.>

- ① Check the actuator label for the model number. This number should match that of the controller/driver.
- ② Check that the Parallel I/O configuration matches (NPN or PNP).

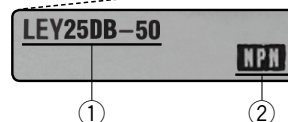

* Refer to the Operation Manual for using the products.
Please download it via our website, <https://www.smcworld.com>







LEY-X7 Series





Step Motor (Servo/24 VDC)

Servo Motor (24 VDC)

Dust-tight/Water-jet-proof (IP65 Equivalent/IP67 Equivalent)

Compatible Controller/Driver

Type	EtherCAT® direct input type 	EtherNet/IP™ direct input type 	PROFINET direct input type 	DeviceNet™ direct input type 	IO-Link direct input type 	CC-Link direct input type 
Series	JXCE1	JXC91	JXCP1	JXCD1	JXCL1	JXCM1
Features	EtherCAT® direct input	EtherNet/IP™ direct input	PROFINET direct input	DeviceNet™ direct input	IO-Link direct input	CC-Link direct input
Compatible motor	Step motor (Servo/24 VDC)					
Max. number of step data	64 points					
Power supply voltage	24 VDC					

Type	Step data input type 	Step data input type 	Programless type 	Pulse input type 
Series	JXC51 JXC61	LECA6	LECP1	LECPA
Features	Parallel I/O	Value (Step data) input Standard controller	Capable of setting up operation (step data) without using a PC or teaching box	Operation by pulse signals
Compatible motor	Step motor (Servo/24 VDC)	Servo motor (24 VDC)	Step motor (Servo/24 VDC)	
Max. number of step data	64 points		14 points	—
Power supply voltage	24 VDC			

Specifications

Step Motor (Servo/24 VDC)

Model		LEY25□-X7			LEY32□-X7			LEY40□-X7						
Actuator specifications	Work load*1 [kg]	Horizontal	For JXC□1 LECP1	(3000 [mm/s ²])	20	40	60	30	45	60	50	60	80	
				(2000 [mm/s ²])	30	55	70	40	60	80	60	70	90	
		Vertical	For LECPA JXC□ ₂	(3000 [mm/s ²])	12	30	30	20	40	40	30	60	60	
				(2000 [mm/s ²])	18	50	50	30	60	60	—	—	—	
		(3000 [mm/s ²])	7	15	29	10	21	42	12	26	52			
	Pushing force [N]*2 *3 *4			63 to 122	126 to 238	232 to 452	80 to 189	156 to 370	296 to 707	132 to 283	266 to 553	562 to 1058		
	Speed [mm/s]*4			18 to 300	9 to 150	5 to 75	24 to 300	12 to 150	6 to 75	24 to 300	12 to 210	6 to 105		
	Max. acceleration/deceleration [mm/s ²]			3000										
	Pushing speed [mm/s]*5			35 or less			30 or less			30 or less				
	Positioning repeatability [mm]			±0.02										
	Lost motion [mm]*6			0.1 or less										
	Screw lead [mm]			12	6	3	16	8	4	16	8	4		
	Impact/Vibration resistance [m/s ²]*7			50/20										
	Actuation type			Ball screw (LEY□D)										
	Guide type			Sliding bushing (Piston rod)										
	Enclosure*8			IP65 equivalent/IP67 equivalent										
	Operating temperature range [°C]			5 to 40										
	Operating humidity range [%RH]			90 or less (No condensation)										
Electric specifications	Motor size			□42			□56.4			□56.4				
	Motor type			Step motor (Servo/24 VDC)										
	Encoder			Incremental A/B phase (800 pulse/rotation)										
	Rated voltage [V]			24 VDC ±10%										
	Power consumption [W]*9			40			50			50				
	Standby power consumption when operating [W]*10			15			48			48				
Max. instantaneous power consumption [W]*11			48			104			106					
Lock unit specifications	Type*12			Non-magnetizing lock										
	Holding force [N]			78	157	294	108	216	421	127	265	519		
	Power consumption [W]*13			5			5			5				
	Rated voltage [V]			24 VDC ±10%										

*1 Horizontal: The maximum value of the work load. An external guide is necessary to support the load. (Friction coefficient of guide: 0.1 or less) The actual work load and transfer speed change according to the condition of the external guide. Also, speed changes according to the work load. Check "Model Selection" on pages 1 and 2.

Vertical: Speed changes according to the work load. Check "Model Selection" on pages 1 and 2.

The values shown in () are the acceleration/deceleration. Set these values to be 3000 [mm/s²] or less.

*2 Pushing force accuracy is ±20% (F.S.).

*3 The thrust setting values for LEY25□ is 38% to 65%, for LEY32□ is 38% to 85%, and for LEY40□ is 35% to 65%. The pushing force values change according to the duty ratio and pushing speed. Check "Model Selection" on page 4.

*4 The speed and force may change depending on the cable length, load, and mounting conditions. Furthermore, if the cable length exceeds 5 m, then it will decrease by up to 10% for each 5 m. (At 15 m: Reduced by up to 20%)

*5 The allowable speed for pushing operation. When push conveying a workpiece, operate at the vertical work load or less.

*6 A reference value for correcting an error in reciprocal operation

*7 Impact resistance: No malfunction occurred when the actuator was tested with a drop tester in both an axial direction and a perpendicular direction to the lead screw. (The test was performed with the actuator in the initial state.)

Vibration resistance: No malfunction occurred in a test ranging between 45 to 2000 Hz. The test was performed in both an axial direction and a perpendicular direction to the lead screw. (The test was performed with the actuator in the initial state.)

*8 Cannot be used in an environment where oil such as cutting oil splashes or it is constantly exposed to water

Take appropriate protective measures. For details on enclosure, refer to "Enclosure" on page 6.

*9 The power consumption (including the controller) is for when the actuator is operating.

*10 The standby power consumption when operating (including the controller) is for when the actuator is stopped in the set position during the operation. Except during the pushing operation

*11 The maximum instantaneous power consumption (including the controller) is for when the actuator is operating. This value can be used for the selection of the power supply.

*12 With lock only

*13 For an actuator with lock, add the power consumption for the lock.

LEY-X7 Series

Step Motor (Servo/24 VDC)

Servo Motor (24 VDC)

Dust-tight/Water-jet-proof (IP65 Equivalent/IP67 Equivalent)

Specifications

Servo Motor (24 VDC)

Model		LEY25□A-X7			
Actuator specifications	Work load*1 [kg]	Horizontal (3000 [mm/s ²])	7	15	30
		Vertical (3000 [mm/s ²])	2	5	11
	Pushing force [N]*2 *3		18 to 35	37 to 72	66 to 130
	Speed [mm/s]		2 to 300	1 to 150	1 to 75
	Max. acceleration/deceleration [mm/s ²]		3000		
	Pushing speed [mm/s]*4		35 or less		
	Positioning repeatability [mm]		±0.02		
	Lost motion [mm]*5		0.1 or less		
	Screw lead [mm]		12	6	3
	Impact/Vibration resistance [m/s ²]*6		50/20		
Actuator specifications	Actuation type		Ball screw + Belt (LEY□) Ball screw (LEY□D)		
	Guide type		Sliding bushing (Piston rod)		
	Enclosure*7		IP65 equivalent/IP67 equivalent		
	Operating temperature range [°C]		5 to 40		
	Operating humidity range [%RH]		90 or less (No condensation)		
	Motor size		□42		
	Motor type		Servo motor (24 VDC)		
Electric specifications	Encoder		Incremental A/B (800 pulse/rotation)/Z phase		
	Rated voltage [V]		24 VDC ±10%		
	Power consumption [W]*8		86		
	Standby power consumption when operating [W]*9		4 (Horizontal)/12 (Vertical)		
	Max. instantaneous power consumption [W]*10		96		
Lock unit specifications	Type*11		Non-magnetizing lock		
	Holding force [N]		78	157	294
	Power consumption [W]*12		5		
	Rated voltage [V]		24 VDC ±10%		

- *1 Horizontal: The maximum value of the work load. An external guide is necessary to support the load. (Friction coefficient of guide: 0.1 or less) The actual work load and transfer speed change according to the condition of the external guide.
Vertical: Speed changes according to the work load. Check "Model Selection" on page 3.
The values shown in () are the acceleration/deceleration. Set these values to be 3000 [mm/s²] or less.
- *2 Pushing force accuracy is ±20% (F.S.).
- *3 The thrust setting values for LEY25A□ is 75% to 95%. The pushing force values change according to the duty ratio and pushing speed. Check "Model Selection" on page 4.
- *4 The allowable speed for pushing operation
When push conveying a workpiece, operate at the vertical work load or less.
- *5 A reference value for correcting an error in reciprocal operation
- *6 Impact resistance: No malfunction occurred when the actuator was tested with a drop tester in both an axial direction and a perpendicular direction to the lead screw. (The test was performed with the actuator in the initial state.)
Vibration resistance: No malfunction occurred in a test ranging between 45 to 2000 Hz. The test was performed in both an axial direction and a perpendicular direction to the lead screw. (The test was performed with the actuator in the initial state.)
- *7 Cannot be used in an environment where oil such as cutting oil splashes or it is constantly exposed to water. Take appropriate protective measures. For details on enclosure, refer to "Enclosure" on page 6.
- *8 The power consumption (including the controller) is for when the actuator is operating.
- *9 The standby power consumption when operating (including the controller) is for when the actuator is stopped in the set position during the operation with the maximum work load. Except during the pushing operation
- *10 The maximum instantaneous power consumption (including the controller) is for when the actuator is operating. This value can be used for the selection of the power supply.
- *11 With lock only
- *12 For an actuator with lock, add the power consumption for the lock.

Weight

Weight: In-line Motor Type

		LEY25D									With lock
Stroke		30	50	100	150	200	250	300	350	400	
Product weight [kg]	Step motor	1.49	1.56	1.73	1.98	2.16	2.33	2.51	2.68	2.86	0.33
	Servo motor	1.45	1.52	1.69	1.94	2.12	2.29	2.47	2.64	2.82	

		LEY32D										With lock	
Stroke		30	50	100	150	200	250	300	350	400	450		500
Product weight [kg]	Step motor	2.59	2.70	2.99	3.37	3.66	3.95	4.23	4.52	4.81	5.09	5.38	0.63

		LEY40D									With lock		
Stroke		30	50	100	150	200	250	300	350	400		450	500
Product weight [kg]	Step motor	2.94	3.05	3.34	3.72	4.01	4.30	4.58	4.87	5.16	5.44	5.73	0.63

Additional Weight

[kg]

Size		25	32	40
Lock		0.33	0.63	0.63
Rod end male thread	Male thread	0.03	0.03	0.03
	Nut	0.02	0.02	0.02
Foot (2 sets including mounting bolt)		0.08	0.14	0.14
Rod flange (including mounting bolt)		0.17	0.20	0.20
Head flange (including mounting bolt)				

Construction

In-line motor type: LEY²⁵₃₂^D₄₀

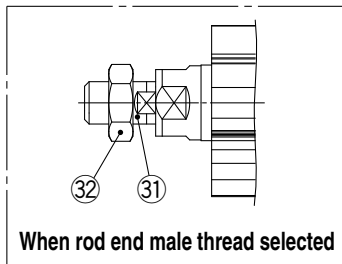
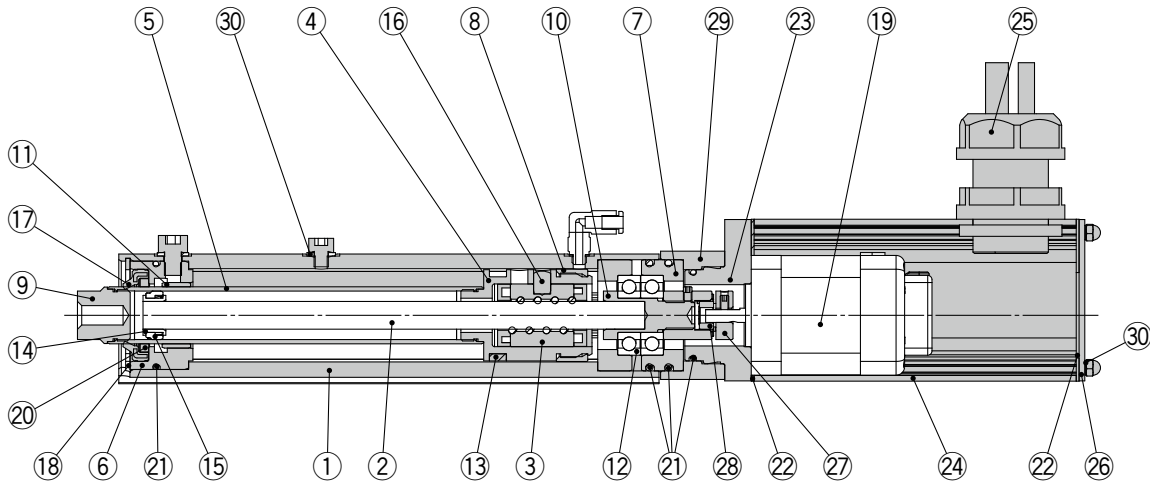

Component Parts

No.	Description	Material	Note
1	Body	Aluminum alloy	Anodized
2	Ball screw	Alloy steel	
3	Ball screw nut	Synthetic resin/Alloy steel	
4	Piston	Aluminum alloy	
5	Piston rod	Stainless steel	Hard chrome plating
6	Rod cover	Aluminum alloy	Anodized
7	Bearing holder	Aluminum alloy	
8	Rotation stopper	Resin	
9	Socket	Stainless steel	
10	Connected shaft	Free cutting carbon steel	Nickel plating
11	Bushing	Bearing alloy	
12	Bearing	—	
13	Magnet	—	
14	Wear ring holder	Stainless steel	Stroke 101 mm or more
15	Wear ring	Resin	Stroke 101 mm or more
16	Parallel pin	Stainless steel	

No.	Description	Material	Note
17	Greater water resistant scraper	Stainless steel/NBR	
18	Retaining ring	Stainless steel	
19	Motor	—	
20	Lube-retainer	Felt	
21	O-ring	NBR	
22	Gasket	Chloroprene	
23	Motor adapter	Aluminum alloy	LEY25 only
24	Motor cover	Aluminum alloy	Anodized
25	Seal connector	—	
26	End cover	Aluminum alloy	Anodized
27	Hub	Aluminum alloy	
28	Spider	NBR	
29	Motor block	Aluminum alloy	Anodized
30	Seal washer	Stainless steel/NBR	
31	Socket (Male thread)	Stainless steel	
32	Nut	Stainless steel	

Replacement Parts/Grease Pack

Applied portion	Order no.
Piston rod	GR-S-010 (10 g)
Piston	GR-S-020 (20 g)

* Apply grease on the piston rod periodically.
Grease should be applied at 1 million cycles or 200 km, whichever comes first.

Water Resistant 2-Color Indicator Solid State Auto Switch: Direct Mounting Type D-M9NA(V)/D-M9PA(V)/D-M9BA(V)

Grommet

- Water (coolant) resistant type
- 2-wire load current is reduced (2.5 to 40 mA).
- The proper operating range can be determined by the color of the light. (Red → Green ← Red)
- Using flexible cable as standard spec.

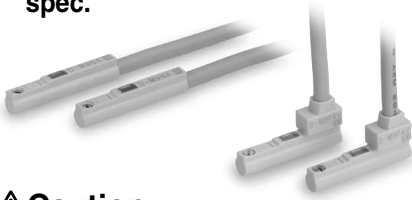

Caution

Precautions

Fix the auto switch with the existing screw installed on the auto switch body. The auto switch may be damaged if a screw other than the one supplied is used. Please consult with SMC if using coolant liquid other than water based solution.

Weight

[g]

Auto switch model	D-M9NA(V)	D-M9PA(V)	D-M9BA(V)
Lead wire length			
0.5 m (Nil)	8	7	
1 m (M)	14	13	
3 m (L)	41	38	
5 m (Z)	68	63	

Dimensions

[mm]

D-M9□A

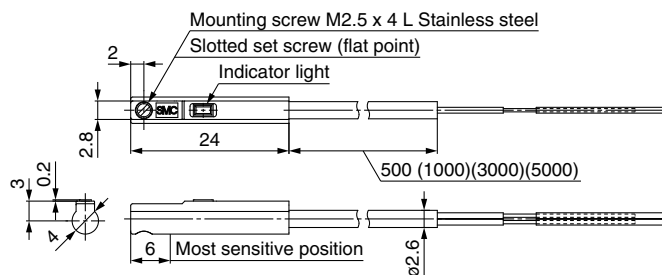

D-M9□AV

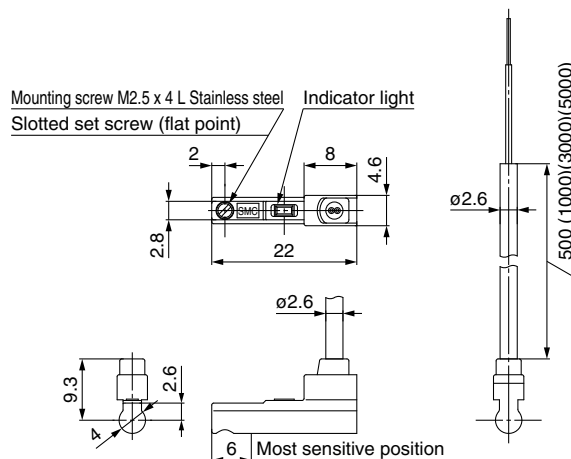

Auto Switch Specifications

PLC: Programmable Logic Controller

D-M9□A, D-M9□AV (With indicator light)						
Auto switch model	D-M9NA	D-M9NAV	D-M9PA	D-M9PAV	D-M9BA	D-M9BAV
Electrical entry direction	In-line	Perpendicular	In-line	Perpendicular	In-line	Perpendicular
Wiring type	3-wire			2-wire		
Output type	NPN		PNP		—	
Applicable load	IC circuit, Relay, PLC				24 VDC relay, PLC	
Power supply voltage	5, 12, 24 VDC (4.5 to 28 V)				—	
Current consumption	10 mA or less				—	
Load voltage	28 VDC or less		—		24 VDC (10 to 28 VDC)	
Load current	40 mA or less				2.5 to 40 mA	
Internal voltage drop	0.8 V or less at 10 mA (2 V or less at 40 mA)				4 V or less	
Leakage current	100 μA or less at 24 VDC				0.8 mA or less	
Indicator light	Operating range Red LED illuminates. Proper operating range Green LED illuminates.					
Standard	CE marking (EMC directive/RoHS directive)					

Oilproof Flexible Heavy-duty Lead Wire Specifications

Auto switch model		D-M9NA□	D-M9NAV□	D-M9PA□	D-M9PAV□	D-M9BA□	D-M9BAV□
Sheath	Outside diameter [mm]	2.6					
Insulator	Number of cores	3 cores (Brown/Blue/Black)			2 cores (Brown/Blue)		
	Outside diameter [mm]	0.88					
Conductor	Effective area [mm ²]	0.15					
	Strand diameter [mm]	0.05					
Minimum bending radius [mm]		17					

* Refer to the **Web Catalog** for solid state auto switch common specifications.

* Refer to the **Web Catalog** for lead wire lengths.

 **Safety Instructions** Be sure to read the "Handling Precautions for SMC Products" (M-E03-3) and "Operation Manual" before use.