

Battery-less Absolute Encoder Type Electric Actuators



Restart from the last stop position is possible.

Easy operation restart after recovery of the power supply

The position information is held by the encoder even when the power supply is turned off. A return to origin operation is not necessary when the power supply is recovered.



Step Motor Controller
JXC Series p. 31, 37

Battery-less absolute type
(Step motor 24 VDC)

No battery is installed.

Reduced maintenance

No battery is used to store the position information. There is no need to manage spare batteries or replacement maintenance.

Applicable network/
Control method

EtherCAT

DeviceNet

EtherNet/IP

IO-Link

PROFINET

CC-Link



JXC□1-E



New CC-Link
JXCM1-E



New Parallel I/O
JXC51/61-E

Compatible Actuators

Slider Type LEF Series

Size 25, 32, 40

p. 1, 9

Belt drive
LEFB Series

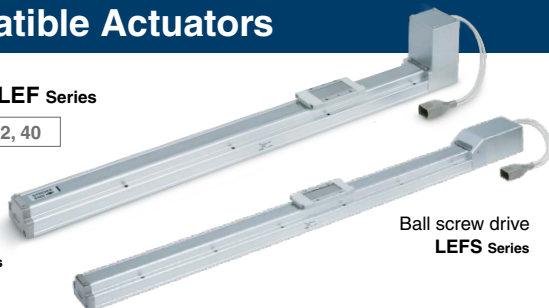

Ball screw drive
LEFS Series

Rod Type/Guide Rod Type

LEY/LEYG Series

Size 25, 32, 40

p. 11, 17



Slide Table

LES Series

Size 25

p. 23, 25



Compact type LES Series



High rigidity type LESH Series

Electric Gripper 2-Finger Type

LEHF Series

Size 32, 40

p. 27



Rotary Table

LER Series

Size 50

p. 29



LE□ Series



CAT.ES100-136A®

LEF Series Model Selection

Speed-Work Load Graph (Guide)

For Battery-less Absolute (Step Motor 24 VDC), In-line Motor Type

Items not listed are the same as those of the standard product. For details, refer to the [Web Catalog](#).

* The following graphs show the values when moving force is 100%.

LEFS25/Ball Screw Drive

Horizontal

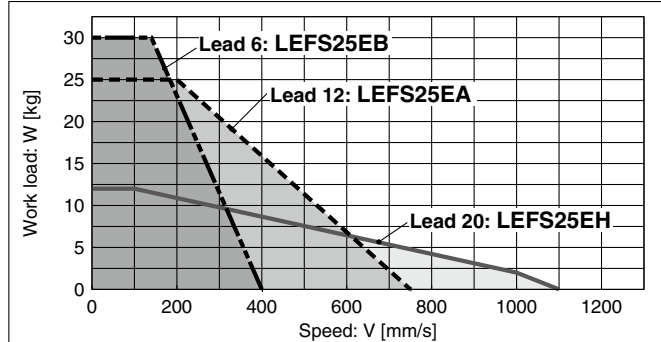

Vertical

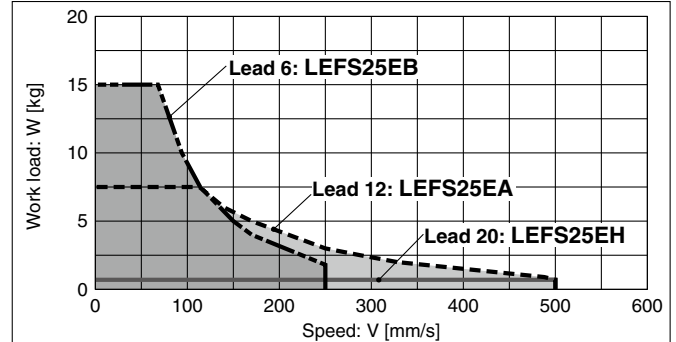

LEFS32/Ball Screw Drive

Horizontal

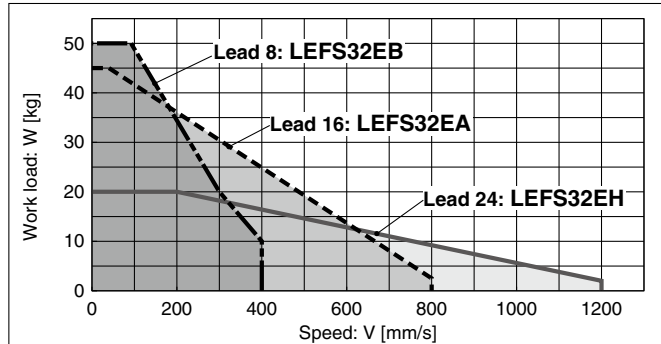

Vertical

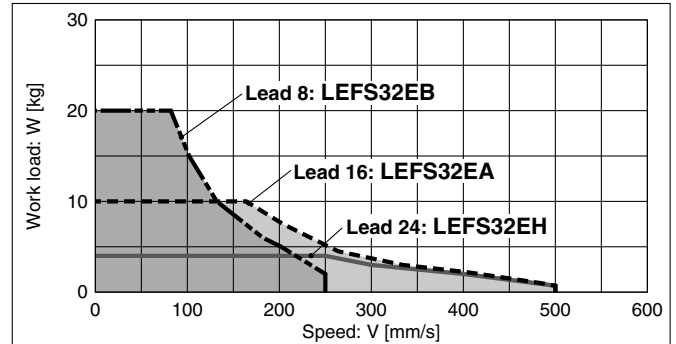

LEFS40/Ball Screw Drive

Horizontal

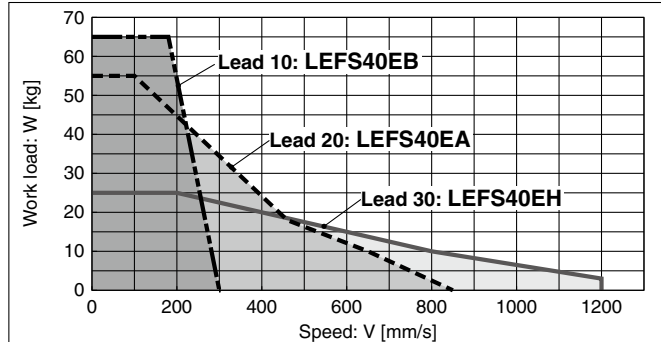

Vertical

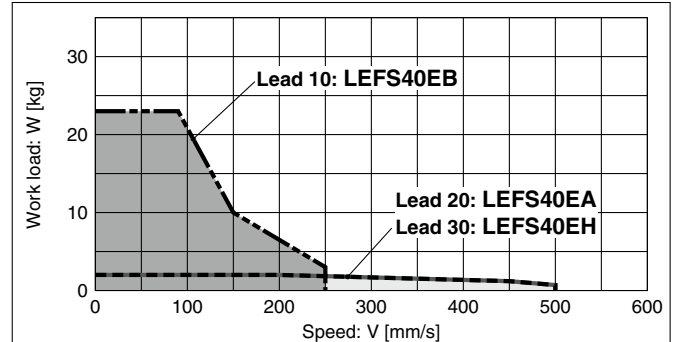

Speed-Work Load Graph (Guide)

For Battery-less Absolute (Step Motor 24 VDC), Motor Parallel Type

Items not listed are the same as those of the standard product. For details, refer to the [Web Catalog](#).

* The following graphs show the values when moving force is 100%.

LEFS25(L/R)/Ball Screw Drive

Horizontal

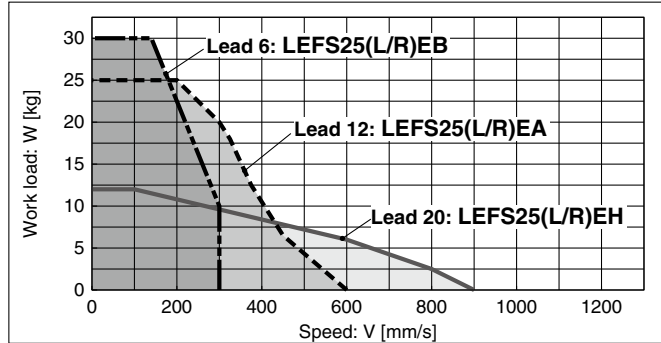

Vertical

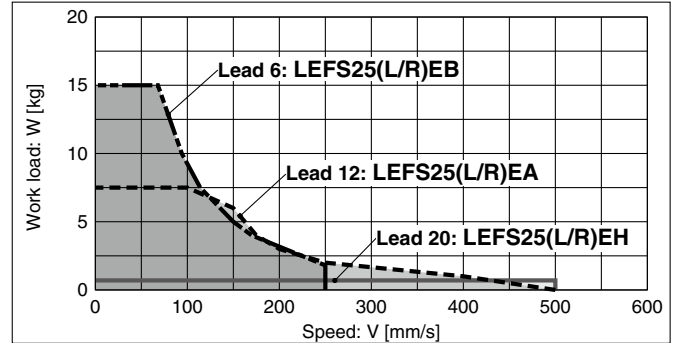

LEFS32(L/R)/Ball Screw Drive

Horizontal

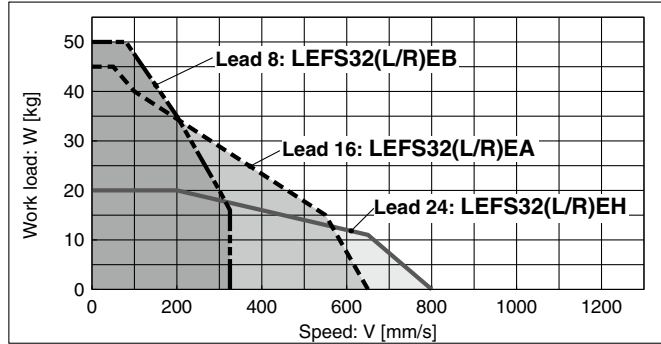

Vertical

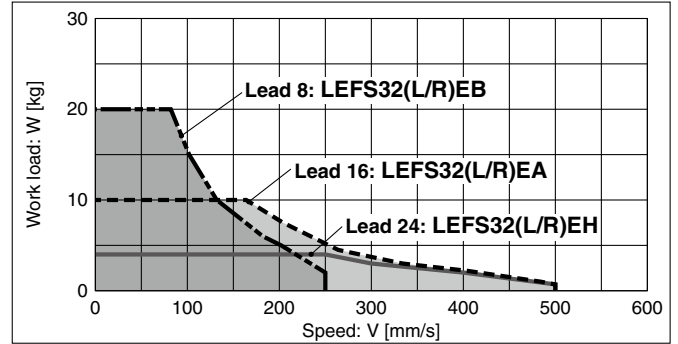

LEFS40(L/R)/Ball Screw Drive

Horizontal

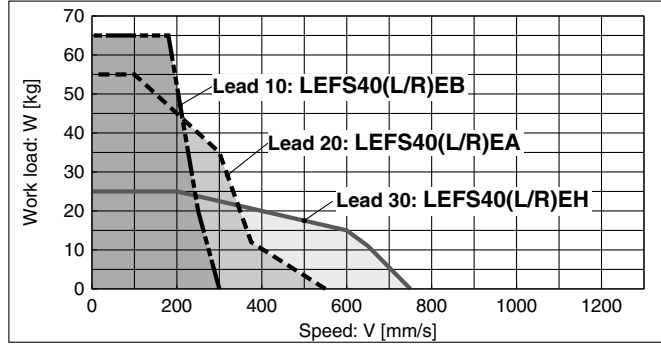

Vertical

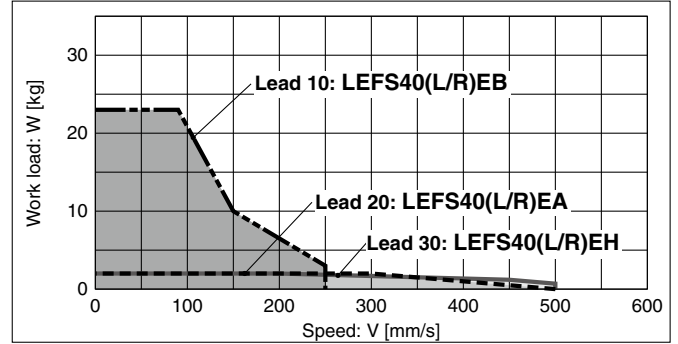

LEFS

LEFB

LEY

LEYG

LES

LESH

LEHF

LER

JXC□1

JXC51/61

Battery-less Absolute Encoder:

Electric Actuator/Slider Type Ball Screw Drive

LEFS Series LEFS25, 32, 40



How to Order



LEFS H 25 R E B - 200 [] C N K - R1 CD17T

① ② ③ ④ ⑤ ⑥ ⑦ ⑧ ⑨ ⑩ ⑪ ⑫

For details on controllers, refer to the next page.

① Accuracy

Nil	Basic type
H	High-precision type

② Size

25
32
40

③ Motor mounting position

Nil	In-line
R	Right side parallel
L	Left side parallel

④ Motor type

E	Battery-less absolute (Step motor 24 VDC)
---	---

⑤ Lead [mm]

Symbol	LEFS25	LEFS32	LEFS40
H	20	24	30
A	12	16	20
B	6	8	10

⑥ Stroke*1 [mm]

Stroke	Note	
	Size	Applicable stroke
50 to 800	25	50, 100, 150, 200, 250, 300, 350, 400, 450, 500, 550, 600, 650, 700, 750, 800
50 to 1000	32	50, 100, 150, 200, 250, 300, 350, 400, 450, 500, 550, 600, 650, 700, 750, 800, 850, 900, 950, 1000
150 to 1200	40	150, 200, 250, 300, 350, 400, 450, 500, 550, 600, 650, 700, 750, 800, 850, 900, 950, 1000, 1100, 1200

⑦ Motor option

Nil	Without option
B	With lock

⑧ Auto switch compatibility (In-line only)*2 *3 *4 *5

Nil	None
C	With (Includes 1 mounting bracket)

⑨ Grease application (Seal band part)

Nil	With
N	Without (Roller specification)

⑩ Positioning pin hole

Nil	Housing B bottom*5	
K	Body bottom 2 locations	

⑪ Actuator cable type/length

Robotic cable [m]			
Nil	None	R8	8*6
R1	1.5	RA	10*6
R3	3	RB	15*6
R5	5	RC	20*6

Items not listed are the same as those of the standard product. For details, refer to the Web Catalog.

For details on auto switches, refer to the Web Catalog.

Battery-less Absolute Encoder: Electric Actuator/Slider Type, Ball Screw Drive **LEFS Series**

12 Controller

Nil	Without controller
C□1□□	With controller

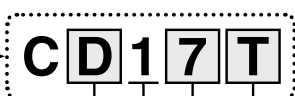

Interface (Communication protocol/Input/Output)

E	EtherCAT®
9	EtherNet/IP™
P	PROFINET
D	DeviceNet™
L	IO-Link
M	CC-Link Ver. 1.10
5	Parallel input (NPN)
6	Parallel input (PNP)

Mounting

7	Screw mounting
8*7	DIN rail

• For single axis

Communication plug connector, I/O cable*8

Symbol	Type	Applicable interface
Nil	Without accessory	—
S	Straight type communication plug connector	DeviceNet™
T	T-branch type communication plug connector	CC-Link Ver. 1.10
1	I/O cable (1.5 m)	Parallel input (NPN) Parallel input (PNP)
3	I/O cable (3 m)	
5	I/O cable (5 m)	

- *1 Please consult with SMC for non-standard strokes as they are produced as special orders.
- *2 If 2 or more are required, please order them separately. (Part no.: LEF-D-2-1 For details, refer to the **Web Catalog**.)
- *3 Order auto switches separately. (For details, refer to the **Web Catalog**.)
- *4 When "Nil" is selected, the product will not come with a built-in magnet for an auto switch, and so a mounting bracket cannot be secured. Be sure to select an appropriate model initially as the product cannot be changed to have auto switch compatibility after purchase.

- *5 For details on the mounting method, refer to the **Web Catalog**.
- *6 Produced upon receipt of order
- *7 The DIN rail is not included. Order it separately.
- *8 Select "Nil" for anything other than DeviceNet™, CC-Link, or parallel input.
Select "Nil," "S," or "T" for DeviceNet™ or CC-Link.
Select "Nil," "1," "3," or "5" for parallel input.

⚠ Caution

[CE-compliant products]

EMC compliance was tested by combining the electric actuator LEF series and the controller JXC series.

The EMC depends on the configuration of the customer's control panel and the relationship with other electrical equipment and wiring. Therefore, compliance with the EMC directive cannot be certified for SMC components incorporated into the customer's equipment under actual operating conditions. As a result, it is necessary for the customer to verify compliance with the EMC directive for the machinery and equipment as a whole.

[Precautions relating to differences in controller versions]

When the JXC series is to be used in combination with the battery-less absolute encoder, use a controller that is version V3.4 or S3.4 or higher. For details, refer to page 45.

The actuator and controller are sold as a package.

Confirm that the combination of the controller and actuator is correct.

<Check the following before use.>

- *1 Check the actuator label for the model number. This number should match that of the controller.



*1



* Refer to the Operation Manual for using the products.
Please download it via our website, <https://www.smcworld.com>

Type	EtherCAT® direct input type	EtherNet/IP™ direct input type	PROFINET direct input type	DeviceNet™ direct input type	IO-Link direct input type	CC-Link direct input type	Step data input type
Series	JXCE1	JXC91	JXCP1	JXCD1	JXCL1	JXCM1	JXC51 JXC61
Features	EtherCAT® direct input	EtherNet/IP™ direct input	PROFINET direct input	DeviceNet™ direct input	IO-Link direct input	CC-Link direct input	Parallel I/O
Compatible motor	Battery-less absolute (Step motor 24 VDC)						
Max. number of step data	64 points						
Power supply voltage	24 VDC						
Reference page	31						37

LEFS
LEFB
LEY
LEYG
LES
LESH
LEHF
LER
JXC□1
JXC51/61

LEFS Series

Specifications

Battery-less Absolute (Step Motor 24 VDC)

Model				LEFS25			LEFS32			LEFS40					
Actuator specifications	Stroke [mm] ^{*1}			50 to 800			50 to 1000			150 to 1200					
	Work load [kg] ^{*2}	Horizontal			12	25	30	20	45	50	25	55	65		
		Vertical			0.5	7.5	15	4	10	20	2	2	23		
	Speed ^{*2} [mm/s]	In-line	Stroke range	Up to 500	20 to 1100	12 to 750	6 to 400	24 to 1200	16 to 800	8 to 400	30 to 1200	20 to 850	10 to 300		
				501 to 600	20 to 900	12 to 540	6 to 270	24 to 1200	16 to 800	8 to 400	30 to 1200	20 to 850	10 to 300		
				601 to 700	20 to 630	12 to 420	6 to 230	24 to 930	16 to 620	8 to 310	30 to 1200	20 to 850	10 to 300		
				701 to 800	20 to 550	12 to 330	6 to 180	24 to 750	16 to 500	8 to 250	30 to 1140	20 to 760	10 to 300		
				801 to 900	—	—	—	24 to 610	16 to 410	8 to 200	30 to 930	20 to 620	10 to 300		
				901 to 1000	—	—	—	24 to 500	16 to 340	8 to 170	30 to 780	20 to 520	10 to 250		
				1001 to 1100	—	—	—	—	—	—	30 to 660	20 to 440	10 to 220		
		1101 to 1200	—	—	—	—	—	—	30 to 570	20 to 380	10 to 190				
		Parallel	Stroke range	Up to 500	20 to 900	12 to 600	6 to 300	24 to 800	16 to 650	8 to 325	30 to 750	20 to 550	10 to 300		
				501 to 600	20 to 900	12 to 540	6 to 270	24 to 800	16 to 650	8 to 325	30 to 750	20 to 550	10 to 300		
				601 to 700	20 to 630	12 to 420	6 to 230	24 to 800	16 to 620	8 to 310	30 to 750	20 to 550	10 to 300		
701 to 800				20 to 550	12 to 330	6 to 180	24 to 750	16 to 500	8 to 250	30 to 750	20 to 550	10 to 300			
801 to 900				—	—	—	24 to 610	16 to 410	8 to 200	30 to 750	20 to 550	10 to 300			
901 to 1000	—			—	—	24 to 500	16 to 340	8 to 170	30 to 750	20 to 520	10 to 250				
1001 to 1100	—			—	—	—	—	—	30 to 660	20 to 440	10 to 220				
1101 to 1200	—	—	—	—	—	—	30 to 570	20 to 380	10 to 190						
Max. acceleration/deceleration [mm/s ²]				3000											
Positioning repeatability [mm]				Basic type									±0.02		
				High-precision type									±0.015 (Lead H: ±0.02)		
Lost motion [mm] ^{*3}				Basic type									0.1 or less		
				High-precision type									0.05 or less		
Lead [mm]				20	12	6	24	16	8	30	20	10			
Impact/Vibration resistance [m/s ²] ^{*4}				50/20											
Actuation type				Ball screw (LEFS□), Ball screw + Belt (LEFS□ ^R)											
Guide type				Linear guide											
Operating temperature range [°C]				5 to 40											
Operating humidity range [%RH]				90 or less (No condensation)											
Motor size				□42			□56.4								
Motor type				Battery-less absolute (Step motor 24 VDC)											
Encoder				Battery-less absolute (4096 pulse/rotation)											
Rated voltage [V]				24 VDC ±10%											
Power consumption [W] ^{*5}				38			50			100					
Standby power consumption when operating [W] ^{*6}				16			44			43					
Max. instantaneous power consumption [W] ^{*7}				57			123			141					
Type ^{*8}				Non-magnetizing lock											
Holding force [N]				47	78	157	72	108	216	75	113	225			
Power consumption [W] ^{*9}				5			5			5					
Rated voltage [V]				24 VDC ±10%											

*1 Please consult with SMC for non-standard strokes as they are produced as special orders.

*2 Speed changes according to the work load. Check "Speed-Work Load Graph (Guide)" on pages 1 and 2.

Furthermore, if the cable length exceeds 5 m, then it will decrease by up to 10% for each 5 m.

*3 A reference value for correcting an error in reciprocal operation

*4 Impact resistance: No malfunction occurred when the actuator was tested with a drop tester in both an axial direction and a perpendicular direction to the lead screw. (The test was performed with the actuator in the initial state.)

Vibration resistance: No malfunction occurred in a test ranging between 45 to 2000 Hz. The test was performed in both an axial direction and a perpendicular direction to the lead screw. (The test was performed with the actuator in the initial state.)

*5 The power consumption (including the controller) is for when the actuator is operating.

*6 The standby power consumption when operating (including the controller) is for when the actuator is stopped in the set position during the operation.

*7 The maximum instantaneous power consumption (including the controller) is for when the actuator is operating. This value can be used for the selection of the power supply.

*8 With lock only

*9 For an actuator with lock, add the power consumption for the lock.

Dimensions: Motor Parallel

LEFS32R

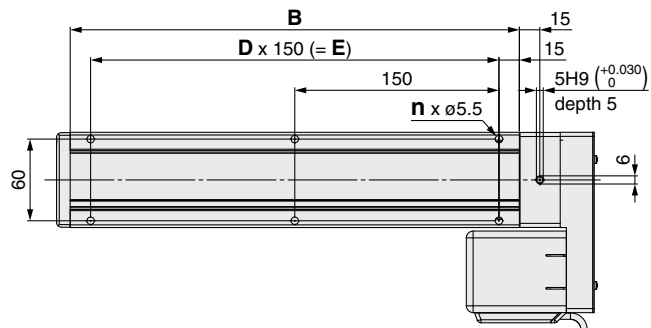
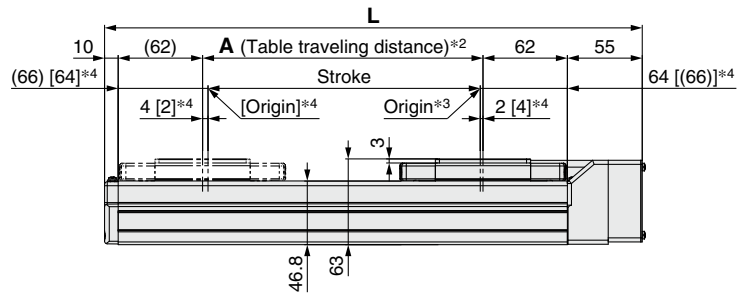
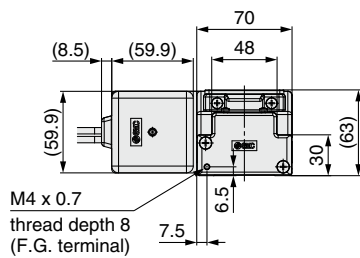
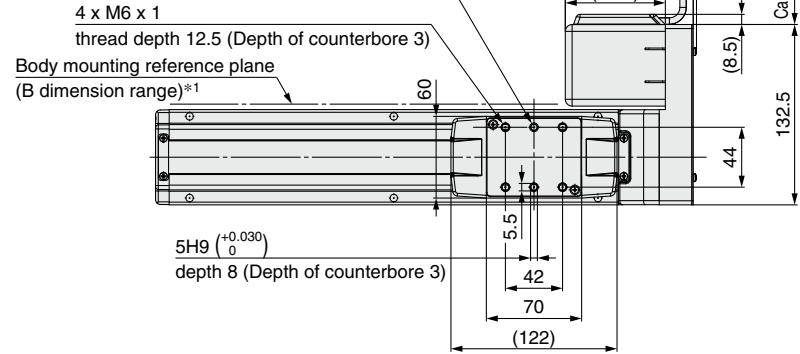
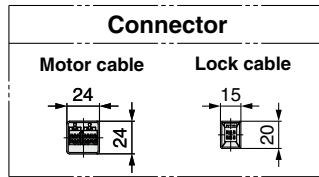
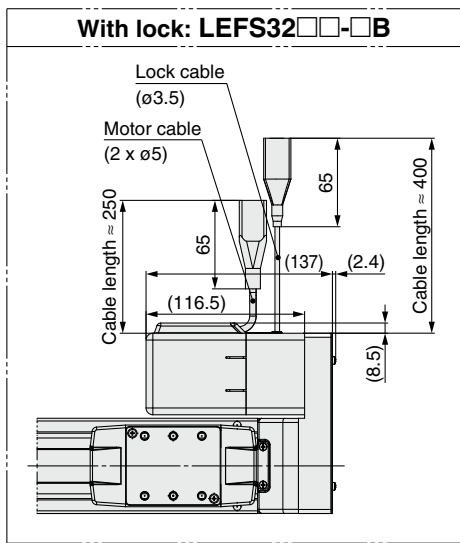

**Motor mounting position: Left side parallel
LEFS32L**

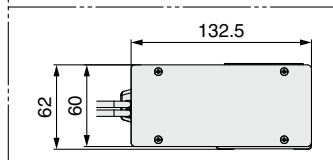

**Motor mounting position: Right side parallel
LEFS32R**

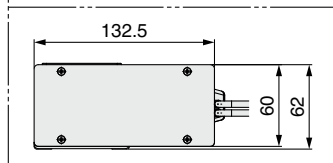

- *1 When mounting the actuator using the body mounting reference plane, set the height of the opposite surface or pin to be 3 mm or more. (Recommended height 5 mm)
In addition, be aware that surfaces other than the body mounting reference plane (B dimension range) may slightly protrude from the body mounting reference plane.
Be sure to provide a clearance of 1 mm or more to avoid interference with workpieces, facilities, etc.
- *2 This is the distance within which the table can move when it returns to origin.
Make sure workpieces mounted on the table do not interfere with the workpieces and facilities around the table.
- *3 Position after return to origin
- *4 [] for when the direction of return to origin has changed

Model	L	A	B	n	D	E
LEFS32□□-50□	245	56	180	4	—	—
LEFS32□□-100□	295	106	230	4	—	—
LEFS32□□-150□	345	156	280	4	—	—
LEFS32□□-200□	395	206	330	6	2	300
LEFS32□□-250□	445	256	380	6	2	300
LEFS32□□-300□	495	306	430	6	2	300
LEFS32□□-350□	545	356	480	8	3	450
LEFS32□□-400□	595	406	530	8	3	450
LEFS32□□-450□	645	456	580	8	3	450
LEFS32□□-500□	695	506	630	10	4	600

Model	L	A	B	n	D	E
LEFS32□□-550□	745	556	680	10	4	600
LEFS32□□-600□	795	606	730	10	4	600
LEFS32□□-650□	845	656	780	12	5	750
LEFS32□□-700□	895	706	830	12	5	750
LEFS32□□-750□	945	756	880	12	5	750
LEFS32□□-800□	995	806	930	14	6	900
LEFS32□□-850□	1045	856	980	14	6	900
LEFS32□□-900□	1095	906	1030	14	6	900
LEFS32□□-950□	1145	956	1080	16	7	1050
LEFS32□□-1000□	1195	1006	1130	16	7	1050

LEFS
LEFB
LEY
LEYG
LES
LESH
LEHF
LER
JXC□1
JXC51/61

LEFS Series

Dimensions: Motor Parallel

LEFS40R

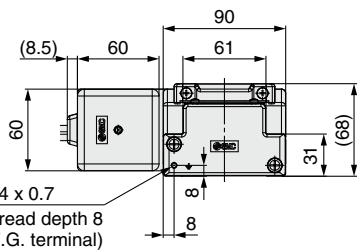
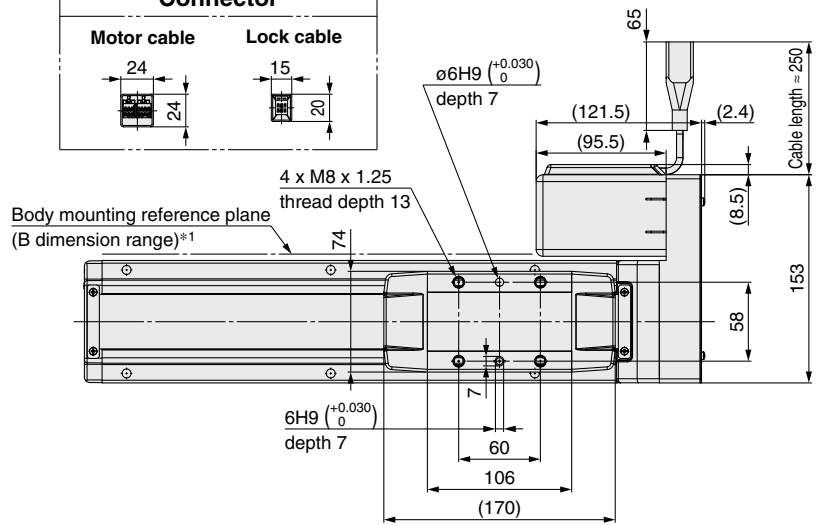
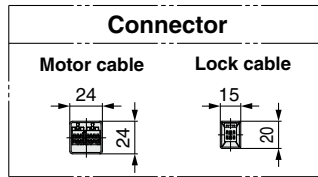
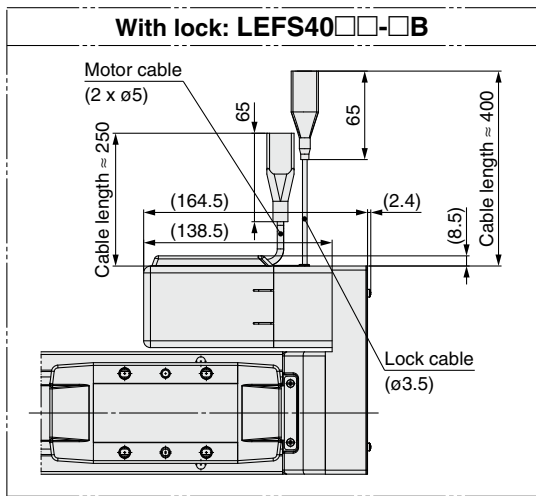

Motor mounting position: Left side parallel LEFS40L□

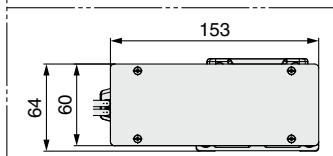

Motor mounting position: Right side parallel LEFS40R□

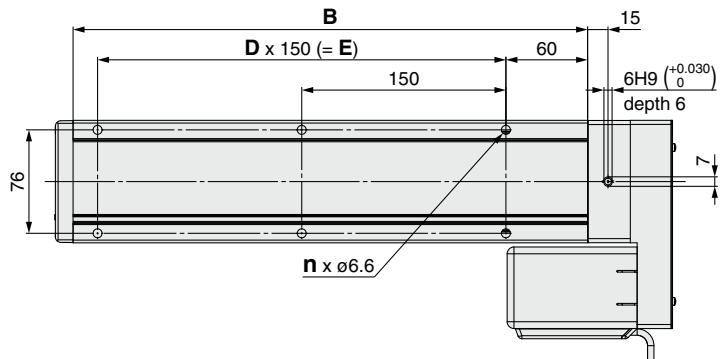
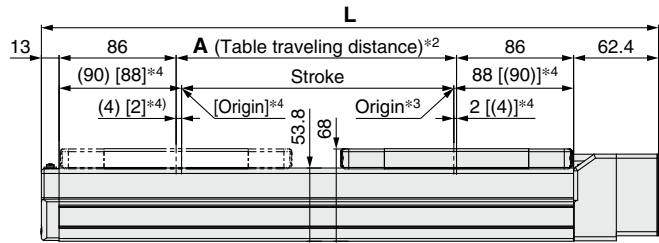
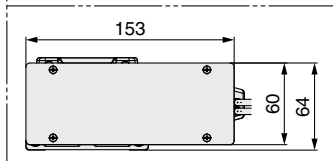

- *1 When mounting the actuator using the body mounting reference plane, set the height of the opposite surface or pin to be 3 mm or more. (Recommended height 5 mm)
In addition, be aware that surfaces other than the body mounting reference plane (B dimension range) may slightly protrude from the body mounting reference plane.
Be sure to provide a clearance of 1 mm or more to avoid interference with workpieces, facilities, etc.
- *2 This is the distance within which the table can move when it returns to origin.
Make sure workpieces mounted on the table do not interfere with the workpieces and facilities around the table.
- *3 Position after return to origin
- *4 [] for when the direction of return to origin has changed

Model	L	A	B	n	D	E
LEFS40□□-150□	403.4	156	328	4	—	150
LEFS40□□-200□	453.4	206	378	6	2	300
LEFS40□□-250□	503.4	256	428	6	2	300
LEFS40□□-300□	553.4	306	478	6	2	300
LEFS40□□-350□	603.4	356	528	8	3	450
LEFS40□□-400□	653.4	406	578	8	3	450
LEFS40□□-450□	703.4	456	628	8	3	450
LEFS40□□-500□	753.4	506	678	10	4	600
LEFS40□□-550□	803.4	556	728	10	4	600
LEFS40□□-600□	853.4	606	778	10	4	600

Model	L	A	B	n	D	E
LEFS40□□-650□	903.4	656	828	12	5	750
LEFS40□□-700□	953.4	706	878	12	5	750
LEFS40□□-750□	1003.4	756	928	12	5	750
LEFS40□□-800□	1053.4	806	978	14	6	900
LEFS40□□-850□	1103.4	856	1028	14	6	900
LEFS40□□-900□	1153.4	906	1078	14	6	900
LEFS40□□-950□	1203.4	956	1128	16	7	1050
LEFS40□□-1000□	1253.4	1006	1178	16	7	1050
LEFS40□□-1100□	1353.4	1106	1278	18	8	1200
LEFS40□□-1200□	1453.4	1206	1378	18	8	1200

JXC51/61

JXC□1

LER

LEHF

LESH

LES

LEYG

LEY

LEFB

LEFS

Battery-less Absolute Encoder:

Electric Actuator/Slider Type Belt Drive

LEFB Series LEFB25, 32



How to Order

LEFB **25** **ET** - **500** **C** **N** **K** - **R1** **CD17T**

①
②
③
④
⑤
⑥
⑦
⑧
⑨
⑩

For details on controllers, refer to the next page.

① Size

25
32

② Motor type

E	Battery-less absolute (Step motor 24 VDC)
---	---

③ Equivalent lead [mm]

T	48
---	----

④ Stroke*1 [mm]

Stroke	Note	
	Size	Applicable stroke
300 to 2000	25	300, 500, 600, 700, 800, 900, 1000, 1200, 1500, 1800, 2000
300 to 2000	32	300, 500, 600, 700, 800, 900, 1000, 1200, 1500, 1800, 2000

⑤ Motor option

Nil	Without option
B	With lock

⑥ Auto switch compatibility*2 *3 *4 *5

Nil	None
C	With (Includes 1 mounting bracket)

⑦ Grease application (Seal band part)

Nil	With
N	Without (Roller specification)

⑧ Positioning pin hole

Nil	Housing B bottom*5	
K	Body bottom 2 locations	

⑨ Actuator cable type/length

Robotic cable [m]			
Nil	None	R8	8*6
R1	1.5	RA	10*6
R3	3	RB	15*6
R5	5	RC	20*6

The belt drive actuator cannot be used for vertical applications.

Items not listed are the same as those of the standard product. For details, refer to the Web Catalog.

For details on auto switches, refer to the Web Catalog.

Battery-less Absolute Encoder: Electric Actuator/Slider Type, Belt Drive **LEFB Series**

⑩ Controller

Nil	Without controller
C□1□□	With controller

C D 1 7 T

Interface (Communication protocol/Input/Output)

E	EtherCAT®
9	EtherNet/IP™
P	PROFINET
D	DeviceNet™
L	IO-Link
M	CC-Link Ver. 1.10
5	Parallel input (NPN)
6	Parallel input (PNP)

Mounting

7	Screw mounting
8*7	DIN rail

• For single axis

Communication plug connector, I/O cable*8

Symbol	Type	Applicable interface
Nil	Without accessory	—
S	Straight type communication plug connector	DeviceNet™
T	T-branch type communication plug connector	CC-Link Ver. 1.10
1	I/O cable (1.5 m)	Parallel input (NPN) Parallel input (PNP)
3	I/O cable (3 m)	
5	I/O cable (5 m)	

- *1 Please consult with SMC for non-standard strokes as they are produced as special orders.
- *2 If 2 or more are required, please order them separately. (Part no.: LEF-D-2-1 For details, refer to the **Web Catalog**.)
- *3 Order auto switches separately. (For details, refer to the **Web Catalog**.)
- *4 When "Nil" is selected, the product will not come with a built-in magnet for an auto switch, and so a mounting bracket cannot be secured. Be sure to select an appropriate model initially as the product cannot be changed to have auto switch compatibility after purchase.

- *5 For details on the mounting method, refer to the **Web Catalog**.
- *6 Produced upon receipt of order
- *7 The DIN rail is not included. Order it separately.
- *8 Select "Nil" for anything other than DeviceNet™, CC-Link, or parallel input.
Select "Nil," "S," or "T" for DeviceNet™ or CC-Link.
Select "Nil," "1," "3," or "5" for parallel input.

⚠ Caution

[CE-compliant products]

EMC compliance was tested by combining the electric actuator LEF series and the controller JXC series.

The EMC depends on the configuration of the customer's control panel and the relationship with other electrical equipment and wiring. Therefore, compliance with the EMC directive cannot be certified for SMC components incorporated into the customer's equipment under actual operating conditions. As a result, it is necessary for the customer to verify compliance with the EMC directive for the machinery and equipment as a whole.

[Precautions relating to differences in controller versions]

When the JXC series is to be used in combination with the battery-less absolute encoder, use a controller that is version V3.4 or S3.4 or higher. For details, refer to page 45.

The actuator and controller are sold as a package.

Confirm that the combination of the controller and actuator is correct.

<Check the following before use.>

- *1 Check the actuator label for the model number. This number should match that of the controller.

LEFB25ET-500

*1



- * Refer to the Operation Manual for using the products. Please download it via our website, <https://www.smcworld.com>

Type	EtherCAT® direct input type	EtherNet/IP™ direct input type	PROFINET direct input type	DeviceNet™ direct input type	IO-Link direct input type	CC-Link direct input type	Step data input type
Series	JXCE1	JXC91	JXCP1	JXCD1	JXCL1	JXCM1	JXC51 JXC61
Features	EtherCAT® direct input	EtherNet/IP™ direct input	PROFINET direct input	DeviceNet™ direct input	IO-Link direct input	CC-Link direct input	Parallel I/O
Compatible motor	Battery-less absolute (Step motor 24 VDC)						
Max. number of step data	64 points						
Power supply voltage	24 VDC						
Reference page	31						37

LEY Series Model Selection

Speed-Work Load Graph (Guide) For Battery-less Absolute (Step Motor 24 VDC)

Items not listed are the same as those of the standard product.
For details, refer to the [Web Catalog](#).

Horizontal

LEY25□E

▨ for acceleration/deceleration: 2000 mm/s²

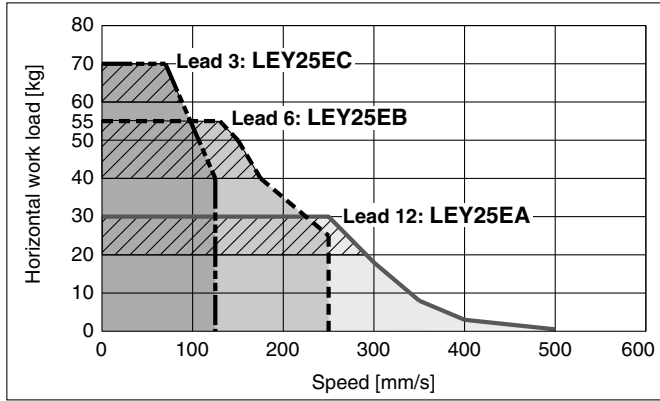

LEY32□E

▨ for acceleration/deceleration: 2000 mm/s²

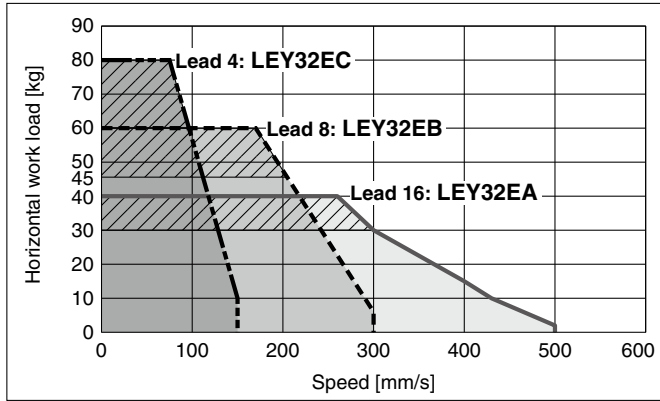

LEY40□E

▨ for acceleration/deceleration: 2000 mm/s²

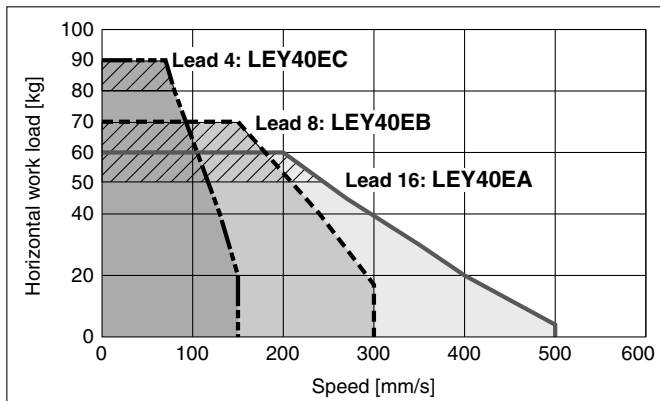

Vertical

LEY25□E

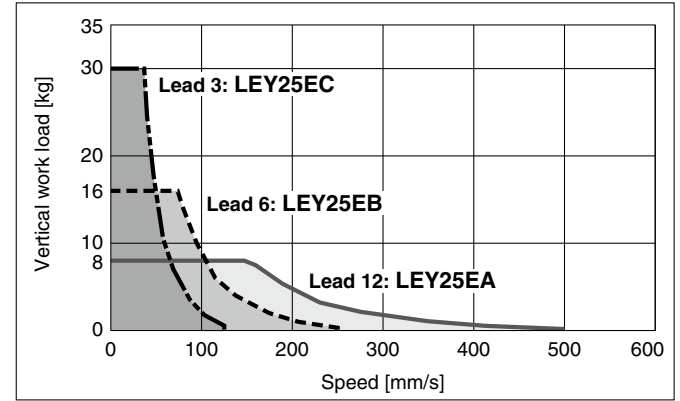

LEY32□E

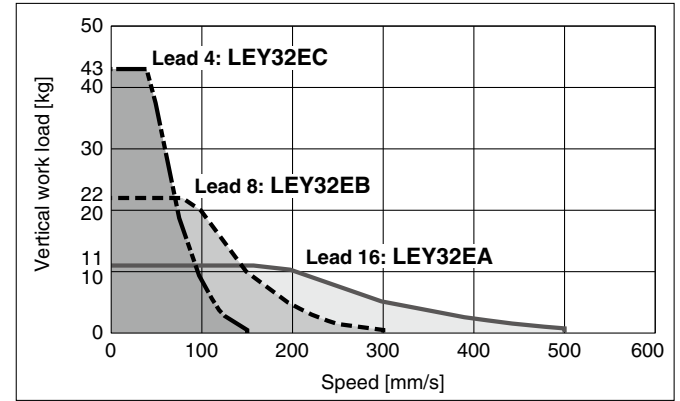

LEY40□E

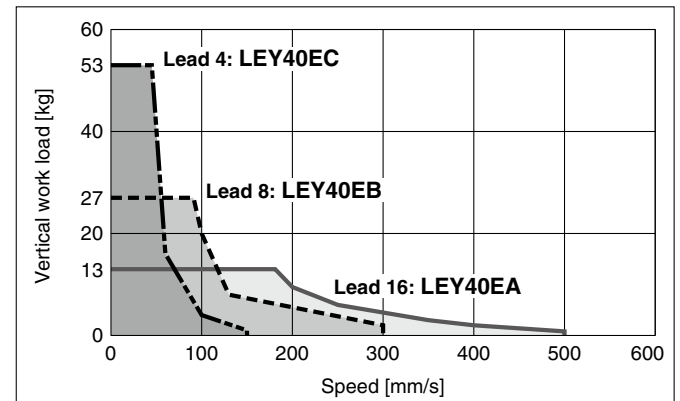

Force Conversion Graph (Guide)

Battery-less Absolute (Step Motor 24 VDC)

LEY25□E

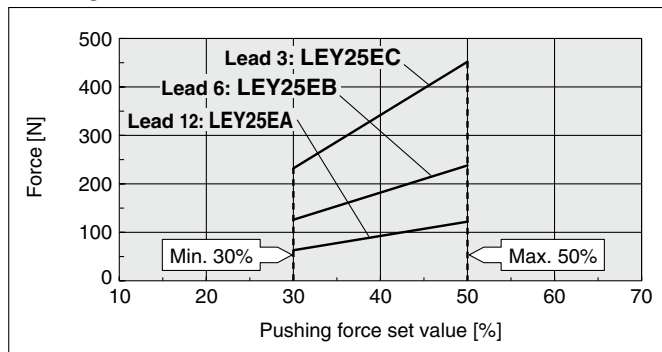

Ambient temperature	Pushing force set value [%]	Duty ratio [%]	Continuous pushing time [min]
40°C or less	50 or less	100	No restriction

LEY32□E

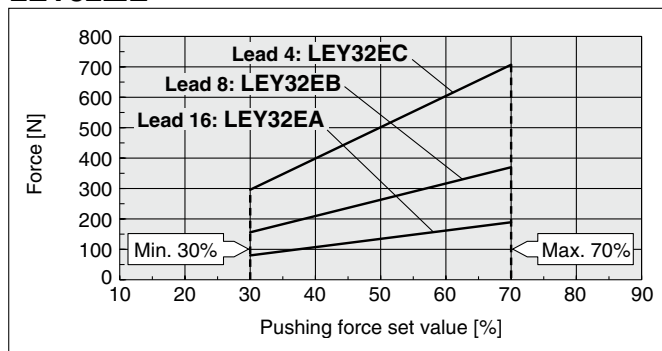

Ambient temperature	Pushing force set value [%]	Duty ratio [%]	Continuous pushing time [min]
40°C or less	70 or less	100	No restriction

LEY40□E

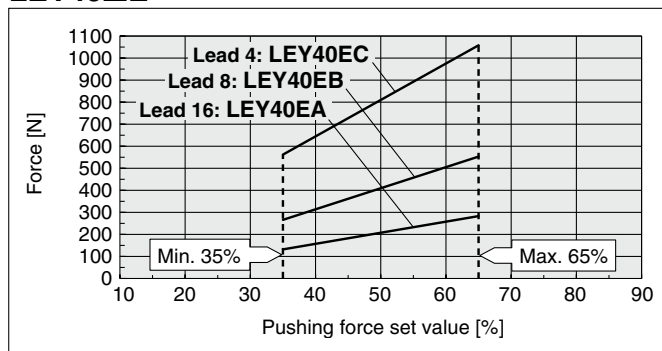

Ambient temperature	Pushing force set value [%]	Duty ratio [%]	Continuous pushing time [min]
40°C or less	65 or less	100	No restriction

Items not listed are the same as those of the standard product.
For details, refer to the **Web Catalog**.

<Limit Values for Pushing Force and Trigger Level in Relation to Pushing Speed>

Model	Lead	Pushing speed [mm/s]	Pushing force (Setting input value)
LEY25□E	A/B/C	21 to 35	40 to 50%
LEY32□E	A	24 to 30	50 to 70%
	B/C	21 to 30	
LEY40□E	A	24 to 30	50 to 65%
	B/C	21 to 30	

<Set Values for Vertical Upward Transfer Pushing Operations>

Model	LEY25□E			LEY32□E			LEY40□E		
Lead	A	B	C	A	B	C	A	B	C
Work load [kg]	2.5	5	10	4.5	9	18	7	14	28
Pushing force	50%			70%			65%		

LEFS

LEFB

LEY

LEYG

LES

LESH

LEHF

LER

JXC□1

JXC51/61

Battery-less Absolute Encoder: Electric Actuator/ Rod Type

LEY Series LEY25, 32, 40



How to Order



Motor mounting position: Top



Motor mounting position: In-line

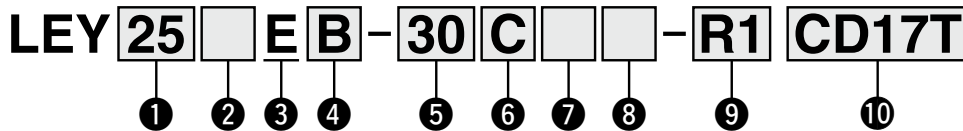

For details on controllers, refer to the next page.

1 Size

25
32
40

2 Motor mounting position

Nil	Top mounting
D	In-line

3 Motor type

E	Battery-less absolute (Step motor 24 VDC)
---	---

4 Lead [mm]

Symbol	LEY25	LEY32/40
A	12	16
B	6	8
C	3	4

5 Stroke*1 [mm]

Stroke	Note	
	Size	Applicable stroke
30 to 400	25	30, 50, 100, 150, 200, 250, 300, 350, 400
30 to 500	32/40	30, 50, 100, 150, 200, 250, 300, 350, 400, 450, 500

6 Motor option*2

C	With motor cover
W	With lock/motor cover

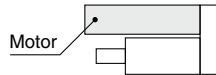

7 Rod end thread

Nil	Rod end female thread
M	Rod end male thread (1 rod end nut is included.)

8 Mounting*3

Symbol	Type	Motor mounting position	
		Top	In-line
Nil	Ends tapped/ Body bottom tapped*4	●	●
L	Foot	●	—
F	Rod flange*4	●*6	●
G	Head flange*4	●*7	—
D	Double clevis*5	●	—

9 Actuator cable type/length

Robotic cable				[m]
Nil	None	R8	8*8	
R1	1.5	RA	10*8	
R3	3	RB	15*8	
R5	5	RC	20*8	

Items not listed are the same as those of the standard product.
For details, refer to the Web Catalog.

10 Controller

Nil	Without controller
C□1□□	With controller



Interface (Communication protocol/Input/Output)

E	EtherCAT®
9	EtherNet/IP™
P	PROFINET
D	DeviceNet™
L	IO-Link
M	CC-Link Ver. 1.10
5	Parallel input (NPN)
6	Parallel input (PNP)

Mounting

7	Screw mounting
8*9	DIN rail

For single axis

Communication plug connector, I/O cable*10

Symbol	Type	Applicable interface
Nil	Without accessory	—
S	Straight type communication plug connector	DeviceNet™
T	T-branch type communication plug connector	CC-Link Ver. 1.10
1	I/O cable (1.5 m)	Parallel input (NPN) Parallel input (PNP)
3	I/O cable (3 m)	
5	I/O cable (5 m)	

- *1 Please consult with SMC for non-standard strokes as they are produced as special orders.
- *2 When "With lock/motor cover" is selected for the top mounting type, the motor body will stick out from the end of the body for size 40 with strokes of 30 mm or less. Check for interference with workpieces before selecting a model.
- *3 The mounting bracket is shipped together with the product but does not come assembled.
- *4 For the horizontal cantilever mounting of the rod flange, head flange, or ends tapped types, use the actuator within the following stroke range.
· LEY25: 200 or less · LEY32/40: 100 or less
- *5 For the mounting of the double clevis type, use the actuator within the

- following stroke range.
· LEY25: 200 or less · LEY32/40: 200 or less
- *6 The rod flange type is not available for the LEY40 with a 30 mm stroke and motor option "With lock/motor cover."
- *7 The head flange type is not available for the LEY32/40.
- *8 Produced upon receipt of order
- *9 The DIN rail is not included. Order it separately.
- *10 Select "Nil" for anything other than DeviceNet™, CC-Link, or parallel input.
Select "Nil," "S," or "T" for DeviceNet™ or CC-Link.
Select "Nil," "1," "3," or "5" for parallel input.

⚠ Caution

[CE-compliant products]

EMC compliance was tested by combining the electric actuator LEY series and the controller JXC series. The EMC depends on the configuration of the customer's control panel and the relationship with other electrical equipment and wiring. Therefore, compliance with the EMC directive cannot be certified for SMC components incorporated into the customer's equipment under actual operating conditions. As a result, it is necessary for the customer to verify compliance with the EMC directive for the machinery and equipment as a whole.

[Precautions relating to differences in controller versions]

When the JXC series is to be used in combination with the battery-less absolute encoder, use a controller that is version V3.4 or S3.4 or higher. For details, refer to page 45.

The actuator and controller are sold as a package.

Confirm that the combination of the controller and actuator is correct.

<Check the following before use.>

- *1 Check the actuator label for the model number. This number should match that of the controller.

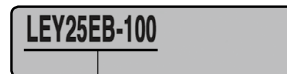

*1



* Refer to the Operation Manual for using the products. Please download it via our website, <https://www.smcworld.com>

Type	EtherCAT® direct input type	EtherNet/IP™ direct input type	PROFINET direct input type	DeviceNet™ direct input type	IO-Link direct input type	CC-Link direct input type	Step data input type
Series	JXCE1	JXC91	JXCP1	JXCD1	JXCL1	JXCM1	JXC51 JXC61
Features	EtherCAT® direct input	EtherNet/IP™ direct input	PROFINET direct input	DeviceNet™ direct input	IO-Link direct input	CC-Link direct input	Parallel I/O
Compatible motor	Battery-less absolute (Step motor 24 VDC)						
Max. number of step data	64 points						
Power supply voltage	24 VDC						
Reference page	31						37

LEFS
LEFB
LEY
LEYG
LES
LESH
LEHF
LER
JXC□1
JXC51/61

LEY Series

Specifications

Battery-less Absolute (Step Motor 24 VDC)

Model			LEY25			LEY32			LEY40																				
Actuator specifications	Work load [kg]*1	Horizontal	(3000 [mm/s ²])	20	40	60	30	45	60	50	60	80																	
			(2000 [mm/s ²])	30	55	70	40	60	80	60	70	90																	
		Vertical	(3000 [mm/s ²])	8	16	30	11	22	43	13	27	53																	
		Pushing force [N]*2*3*4	63 to 122			126 to 238			232 to 452			80 to 189			156 to 370			296 to 707			132 to 283			266 to 553			562 to 1058		
		Speed [mm/s]*4	18 to 500			9 to 250			5 to 125			24 to 500			12 to 300			6 to 150			24 to 500			12 to 300			6 to 150		
		Max. acceleration/deceleration [mm/s ²]	3000																										
		Pushing speed [mm/s]*5	35 or less						30 or less						30 or less														
		Positioning repeatability [mm]	±0.02																										
		Lost motion [mm]*6	0.1 or less																										
		Screw lead [mm]	12	6	3	16	8	4	16	8	4																		
		Impact/Vibration resistance [m/s ²]*7	50/20																										
	Electric specifications	Actuation type		Ball screw + Belt (LEY□□)/Ball screw (LEY□□D)																									
Guide type		Sliding bushing (Piston rod)																											
Operating temperature range [°C]		5 to 40																											
Operating humidity range [%RH]		90 or less (No condensation)																											
Motor size		□42			□56.4			□56.4																					
Motor type		Battery-less absolute (Step motor 24 VDC)																											
Encoder		Battery-less absolute (4096 pulse/rotation)																											
Rated voltage [V]		24 VDC ±10%																											
Power consumption [W]*8		40			50			50																					
Standby power consumption when operating [W]*9		15			48			48																					
Max. instantaneous power consumption [W]*10		48			104			106																					
Lock unit specifications	Type*11		Non-magnetizing lock																										
	Holding force [N]		78	157	294	108	216	421	127	265	519																		
	Power consumption [W]*12		5			5			5																				
Rated voltage [V]		24 VDC ±10%																											

*1 Horizontal: The maximum value of the work load. An external guide is necessary to support the load (Friction coefficient of guide: 0.1 or less). The actual work load and transfer speed change according to the condition of the external guide. Also, speed changes according to the work load. Check "Model Selection" on page 11.

Vertical: Speed changes according to the work load. Check "Model Selection" on page 11.

The values shown in () are the acceleration/deceleration.

Set these values to be 3000 [mm/s²] or less.

*2 Pushing force accuracy is ±20% (F.S.).

*3 The pushing force values for LEY25□E is 30% to 50%, for LEY32□E is 30% to 70%, and for LEY40□E is 35% to 65%.

The pushing force values change according to the duty ratio and pushing speed. Check "Model Selection" in the **Web Catalog**.

*4 The speed and force may change depending on the cable length, load, and mounting conditions. Furthermore, if the cable length exceeds 5 m, then it will decrease by up to 10% for each 5 m. (At 15 m: Reduced by up to 20%)

*5 The allowable speed for pushing operation. When push conveying a workpiece, operate at the vertical work load or less.

*6 A reference value for correcting an error in reciprocal operation

*7 Impact resistance: No malfunction occurred when the actuator was tested with a drop tester in both an axial direction and a perpendicular direction to the lead screw. (The test was performed with the actuator in the initial state.)

Vibration resistance: No malfunction occurred in a test ranging between 45 to 2000 Hz. The test was performed in both an axial direction and a perpendicular direction to the lead screw. (The test was performed with the actuator in the initial state.)

*8 The power consumption (including the controller) is for when the actuator is operating.

*9 The standby power consumption when operating (including the controller) is for when the actuator is stopped in the set position during the operation. Except during the pushing operation

*10 The maximum instantaneous power consumption (including the controller) is for when the actuator is operating. This value can be used for the selection of the power supply.

*11 With lock only

*12 For an actuator with lock, add the power consumption for the lock.

Dimensions

Motor top mounting type

With motor cover: LEY32□□B-□C
25 A
40 C

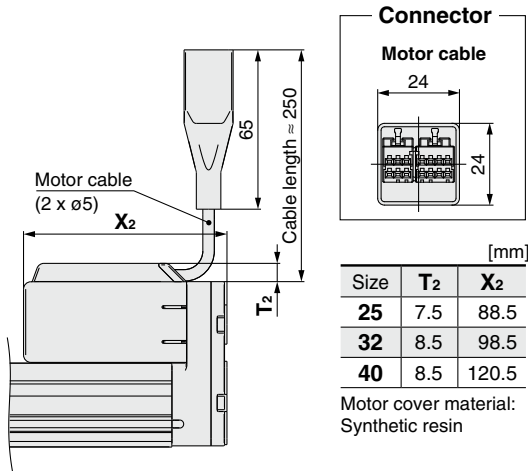

With lock/motor cover: LEY32□□B-□W
25 A
40 C

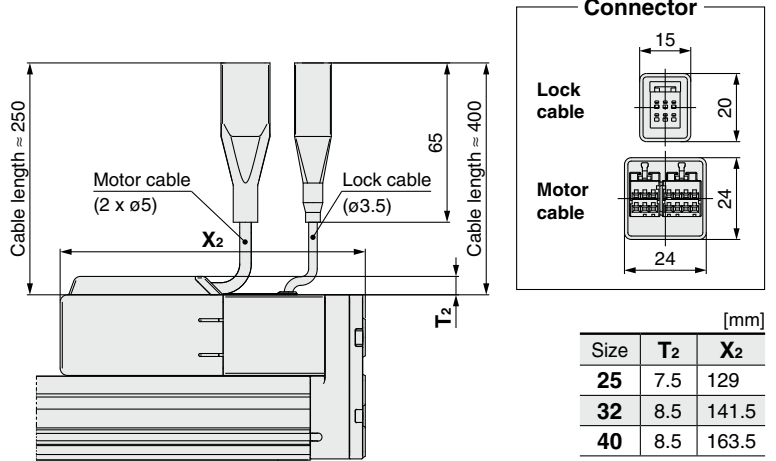

In-line motor type

With motor cover: LEY32D□B-□C
25 A
40 C

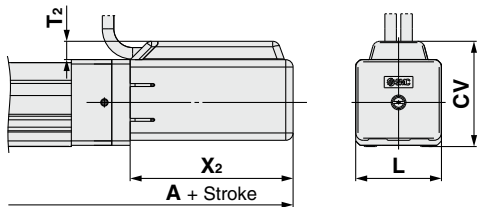

Size	Stroke range	A	T ₂	X ₂	L	CV
25	100st or less	198.5	7.5	68.5	46	54.5
	101st or more, 400st or less	223.5				
32	100st or less	220	8.5	73.5	60	69.5
	101st or more, 500st or less	250				
40	100st or less	242	8.5	95.5	60	69.5
	101st or more, 500st or less	272				

With lock/motor cover: LEY32D□B-□W
25 A
40 C

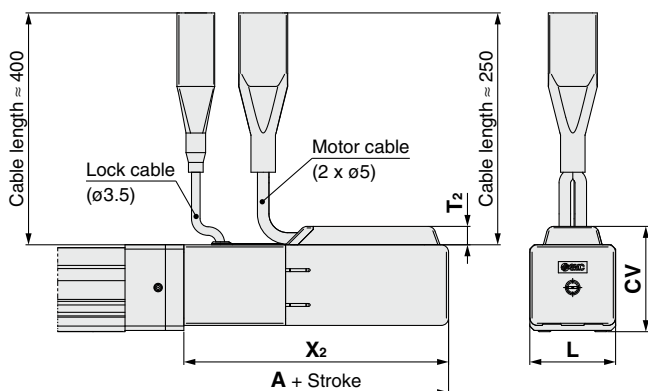

Size	Stroke range	A	T ₂	X ₂	L	CV
25	100st or less	239	7.5	109	46	54.4
	101st or more, 400st or less	264				
32	100st or less	263	8.5	116.5	60	69.5
	101st or more, 500st or less	293				
40	100st or less	285	8.5	138.5	60	69.5
	101st or more, 500st or less	315				

The connector size and motor height are different. Dimensions not listed are the same as those of the standard product.

LEFS
LEFB
LEY
LEYG
LES
LESH
LEHF
LER
JXC□1
JXC51/61

LEYG Series Model Selection

Speed-Work Load Graph (Guide) For Battery-less Absolute (Step Motor 24 VDC)

Items not listed are the same as those of the standard product.
For details, refer to the [Web Catalog](#).

Horizontal

LEYG25^M_L□E ▨ for acceleration/deceleration: 2000 mm/s²

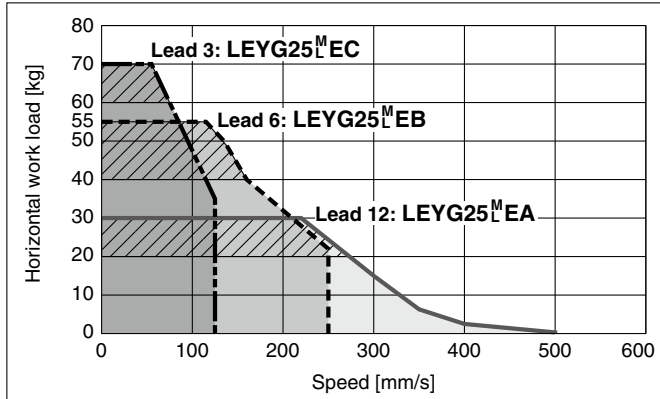

LEYG32^M_L□E ▨ for acceleration/deceleration: 2000 mm/s²

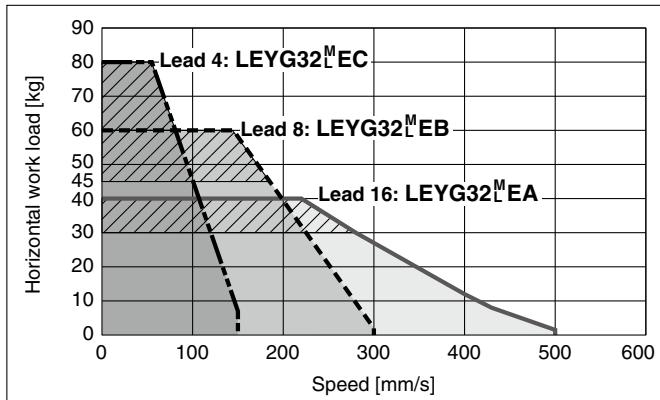

LEYG40^M_L□E ▨ for acceleration/deceleration: 2000 mm/s²

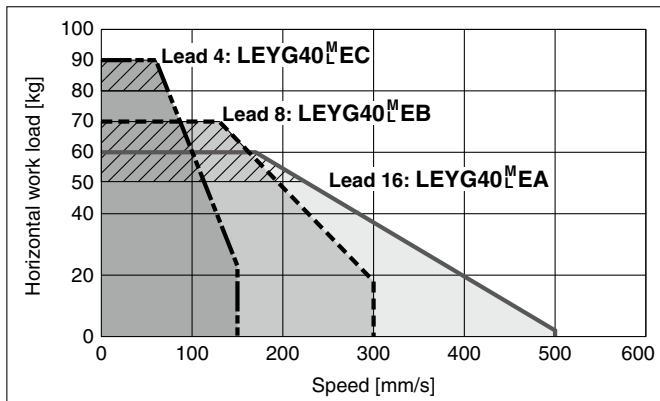

Vertical

LEYG25^M_L□E

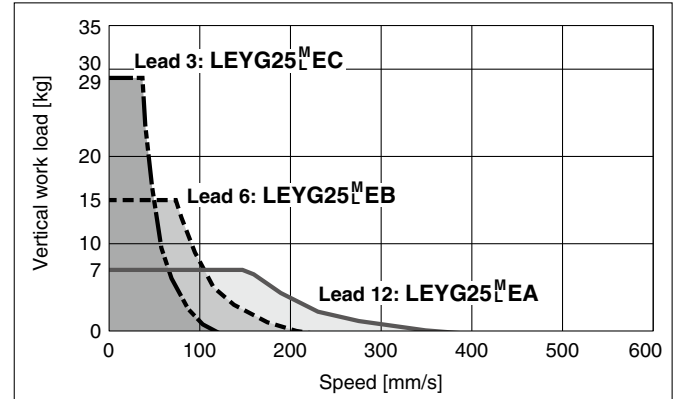

LEYG32^M_L□E

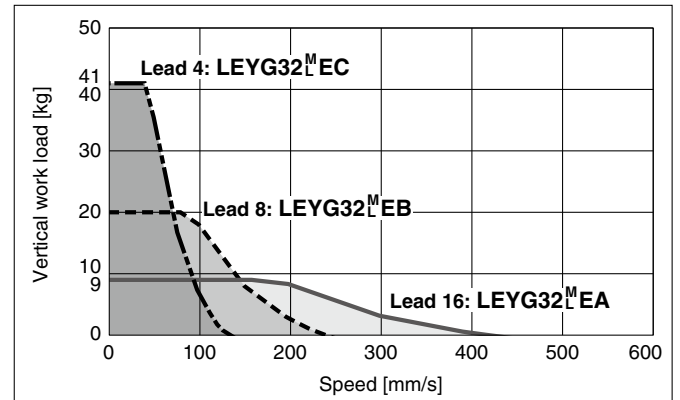

LEYG40^M_L□E

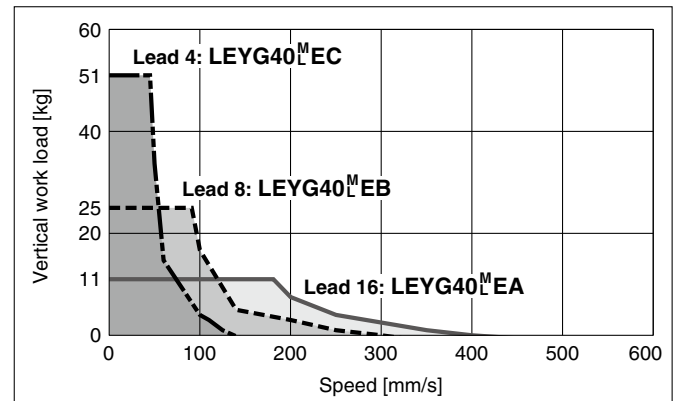

Force Conversion Graph (Guide)

Battery-less Absolute (Step Motor 24 VDC)

LEYG25^M_L□E

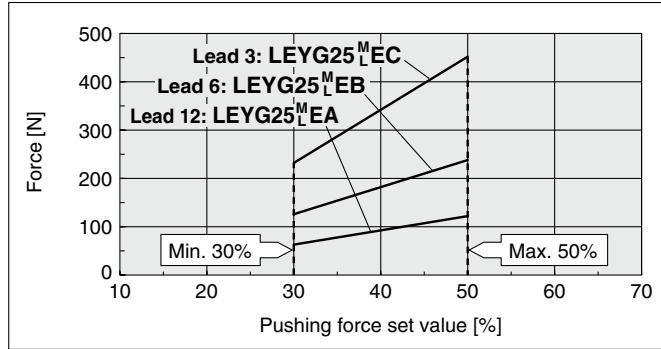

Ambient temperature	Pushing force set value [%]	Duty ratio [%]	Continuous pushing time [min]
40°C or less	50 or less	100	No restriction

LEYG32^M_L□E

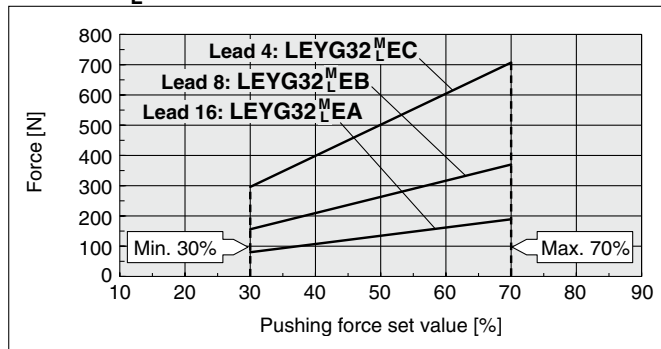

Ambient temperature	Pushing force set value [%]	Duty ratio [%]	Continuous pushing time [min]
40°C or less	70 or less	100	No restriction

LEYG40^M_L□E

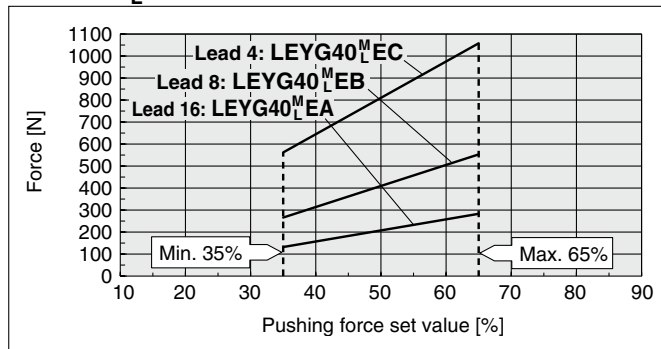

Ambient temperature	Pushing force set value [%]	Duty ratio [%]	Continuous pushing time [min]
40°C or less	65 or less	100	No restriction

Items not listed are the same as those of the standard product.
For details, refer to the **Web Catalog**.

<Limit Values for Pushing Force and Trigger Level in Relation to Pushing Speed>

Model	Lead	Pushing speed [mm/s]	Pushing force (Setting input value)
LEYG25 ^M _L □E	A/B/C	21 to 35	40 to 50%
LEYG32 ^M _L □E	A	24 to 30	50 to 70%
	B/C	21 to 30	
LEYG40 ^M _L □E	A	24 to 30	50 to 65%
	B/C	21 to 30	

<Set Values for Vertical Upward Transfer Pushing Operations>

Model	LEYG25 ^M _L □E			LEYG32 ^M _L □E			LEYG40 ^M _L □E			
	Lead	A	B	C	A	B	C	A	B	C
Work load [kg]		1.5	4	9	2.5	7	16	5	12	26
Pushing force		50%			70%			65%		

LEFS

LEFB

LEY

LEYG

LES

LESH

LEHF

LER

JXC□1

JXC51/61

Battery-less Absolute Encoder: Electric Actuator/ Guide Rod Type

LEYG Series LEYG25, 32, 40



How to Order

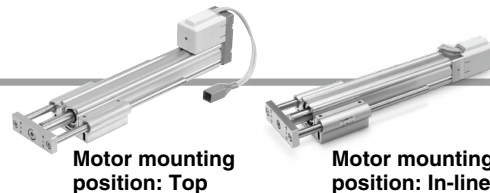

LEYG **25** **M** **E** **B** - **50** **C** - **R1** **CD17T**

① ② ③ ④ ⑤ ⑥ ⑦ ⑧ ⑨ ⑩

For details on controllers, refer to the next page.

① Size

25
32
40

② Bearing type*1

M	Sliding bearing
L	Ball bushing bearing

③ Motor mounting position

Nil	Top mounting
D	In-line

④ Motor type

E	Battery-less absolute (Step motor 24 VDC)
----------	---

⑤ Lead [mm]

Symbol	LEYG25	LEYG32/40
A	12	16
B	6	8
C	3	4

⑥ Stroke*2 *3 [mm]

Stroke	Applicable stroke
30 to 300	30, 50, 100, 150, 200, 250, 300

⑦ Motor option*4

C	With motor cover
W	With lock/motor cover

⑧ Guide option*5

Nil	Without option
F	With grease retaining function

⑨ Actuator cable type/length

Robotic cable [m]			
Nil	None	R8	8*6
R1	1.5	RA	10*6
R3	3	RB	15*6
R5	5	RC	20*6

For details on auto switches, refer to the Web Catalog.

Use of auto switches for the guide rod type LEYG series

- Auto switches must be inserted from the front side with the rod (plate) sticking out.
- Auto switches cannot be fixed with the parts hidden behind the guide attachment (the side of the rod that sticks out).
- Please consult with SMC when using auto switches on the side of the rod that sticks out, as it is produced as a special order.

Items not listed are the same as those of the standard product.
For details, refer to the Web Catalog.

⑩ Controller

Nil	Without controller
C□1□□	With controller

CD17T

Interface (Communication protocol/Input/Output)

E	EtherCAT®
9	EtherNet/IP™
P	PROFINET
D	DeviceNet™
L	IO-Link
M	CC-Link Ver. 1.10
5	Parallel input (NPN)
6	Parallel input (PNP)

Mounting

7	Screw mounting
8*7	DIN rail

For single axis

Communication plug connector, I/O cable*8

Symbol	Type	Applicable interface
Nil	Without accessory	—
S	Straight type communication plug connector	DeviceNet™
T	T-branch type communication plug connector	CC-Link Ver. 1.10
1	I/O cable (1.5 m)	Parallel input (NPN) Parallel input (PNP)
3	I/O cable (3 m)	
5	I/O cable (5 m)	

- *1 When [M: Sliding bearing] is selected, the maximum speed of lead [A] is 400 mm/s (at no-load, horizontal mounting). The speed is also restricted with a horizontal/moment load. Refer to "Model Selection" in the **Web Catalog**.
- *2 Please consult with SMC for non-standard strokes as they are produced as special orders.
- *3 There is a limit for mounting size 32/40 top mounting types and strokes of 50 mm or less. Refer to the dimensions.
- *4 When "With lock/motor cover" is selected for the top mounting type, the motor body will stick out from the end of the body for size 40 with

- strokes of 30 mm or less. Check for interference with workpieces before selecting a model.
- *5 Only available for size 25, 32, and 40 sliding bearings (Refer to "Construction" in the **Web Catalog**.)
- *6 Produced upon receipt of order
- *7 The DIN rail is not included. Order it separately.
- *8 Select "Nil" for anything other than DeviceNet™, CC-Link, or parallel input. Select "Nil," "S," or "T" for DeviceNet™ or CC-Link. Select "Nil," "1," "3," or "5" for parallel input.

⚠ Caution

[CE-compliant products]

EMC compliance was tested by combining the electric actuator LEY series and the controller JXC series.

The EMC depends on the configuration of the customer's control panel and the relationship with other electrical equipment and wiring. Therefore, compliance with the EMC directive cannot be certified for SMC components incorporated into the customer's equipment under actual operating conditions. As a result, it is necessary for the customer to verify compliance with the EMC directive for the machinery and equipment as a whole.

[Precautions relating to differences in controller versions]

When the JXC series is to be used in combination with the battery-less absolute encoder, use a controller that is version V3.4 or S3.4 or higher. For details, refer to page 45.

The actuator and controller are sold as a package.

Confirm that the combination of the controller and actuator is correct.

<Check the following before use.>

- *1 Check the actuator label for the model number. This number should match that of the controller.

LEYG25MEB-100

*1



* Refer to the Operation Manual for using the products. Please download it via our website, <https://www.smcworld.com>

Type	EtherCAT® direct input type	EtherNet/IP™ direct input type	PROFINET direct input type	DeviceNet™ direct input type	IO-Link direct input type	CC-Link direct input type	Step data input type
Series	JXCE1	JXC91	JXCP1	JXCD1	JXCL1	JXCM1	JXC51 JXC61
Features	EtherCAT® direct input	EtherNet/IP™ direct input	PROFINET direct input	DeviceNet™ direct input	IO-Link direct input	CC-Link direct input	Parallel I/O
Compatible motor	Battery-less absolute (Step motor 24 VDC)						
Max. number of step data	64 points						
Power supply voltage	24 VDC						
Reference page	31						37

LEYG Series

Specifications

Battery-less Absolute (Step Motor 24 VDC)

Model			LEYG25 ^M _L			LEYG32 ^M _L			LEYG40 ^M _L			
Actuator specifications	Work load [kg] ^{*1}	Horizontal	Acceleration/Deceleration at 3000 [mm/s ²]	20	40	60	30	45	60	50	60	80
		Vertical	Acceleration/Deceleration at 2000 [mm/s ²]	30	55	70	40	60	80	60	70	90
			Acceleration/Deceleration at 3000 [mm/s ²]	7	15	29	9	20	41	11	25	51
	Pushing force [N] ^{*2*3*4}			63 to 122	126 to 238	232 to 452	80 to 189	156 to 370	296 to 707	132 to 283	266 to 553	562 to 1058
	Speed [mm/s] ^{*4}			18 to 500	9 to 250	5 to 125	24 to 500	12 to 300	6 to 150	24 to 500	12 to 300	6 to 150
	Max. acceleration/deceleration [mm/s ²]			3000								
	Pushing speed [mm/s] ^{*5}			35 or less			30 or less			30 or less		
	Positioning repeatability [mm]			±0.02								
	Lost motion [mm] ^{*6}			0.1 or less								
	Screw lead [mm]			12	6	3	16	8	4	16	8	4
Impact/Vibration resistance [m/s ²] ^{*7}			50/20									
Actuation type			Ball screw + Belt (LEYG□□□), Ball screw (LEYG□□□D)									
Guide type			Sliding bearing (LEYG□□M), Ball bushing bearing (LEYG□□L)									
Operating temp. range [°C]			5 to 40									
Operating humidity range [%RH]			90 or less (No condensation)									
Electric specifications	Motor size			□42			□56.4			□56.4		
	Motor type			Battery-less absolute (Step motor 24 VDC)								
	Encoder			Battery-less absolute (4096 pulse/rotation)								
	Rated voltage [V]			24 VDC ±10%								
	Power consumption [W] ^{*8}			40			50			50		
	Standby power consumption when operating [W] ^{*9}			15			48			48		
	Max. instantaneous power consumption [W] ^{*10}			48			104			106		
Lock unit specifications	Type ^{*11}			Non-magnetizing lock								
	Holding force [N]			78	157	294	108	216	421	127	265	519
	Power consumption [W] ^{*12}			5			5			5		
	Rated voltage [V]			24 VDC ±10%								

*1 Horizontal: An external guide is necessary to support the load (Friction coefficient of guide: 0.1 or less). The actual work load and transfer speed change according to the condition of the external guide. Also, speed changes according to the work load. Check "Model Selection" on page 17.
Vertical: Speed changes according to the work load. Check "Model Selection" on page 17.

Set the acceleration/deceleration values to be 3000 [mm/s²] or less.

*2 Pushing force accuracy is ±20% (F.S.).

*3 The pushing force values for LEYG25□□□E is 30% to 50%, for LEYG32□□□E is 30% to 70%, and for LEYG40□□□E is 35% to 65%.

The pushing force values change according to the duty ratio and pushing speed. Check "Model Selection" in the **Web Catalog**.

*4 The speed and force may change depending on the cable length, load and mounting conditions. Furthermore, if the cable length exceeds 5 m, then it will decrease by up to 10% for each 5 m. (At 15 m: Reduced by up to 20%)

When [M: Sliding bearing] is selected, the maximum speed of lead [A] is 400 mm/s (at no-load, horizontal mounting).

The speed is also restricted with a horizontal/moment load. Refer to "Model Selection" in the **Web Catalog**.

*5 The allowable speed for the pushing operation

*6 A reference value for correcting an error in reciprocal operation

*7 Impact resistance: No malfunction occurred when it was tested with a drop tester in both an axial direction and a perpendicular direction to the lead screw. (The test was performed with the actuator in the initial state.)

Vibration resistance: No malfunction occurred in a test ranging between 45 to 2000 Hz. The test was performed in both an axial direction and a perpendicular direction to the lead screw. (The test was performed with the actuator in the initial state.)

*8 The power consumption (including the controller) is for when the actuator is operating.

*9 The standby power consumption when operating (including the controller) is for when the actuator is stopped in the set position during the operation. Except during the pushing operation

*10 The maximum instantaneous power consumption (including the controller) is for when the actuator is operating. This value can be used for the selection of the power supply.

*11 With lock only

*12 For an actuator with lock, add the power consumption for the lock.

Dimensions

Motor top mounting type

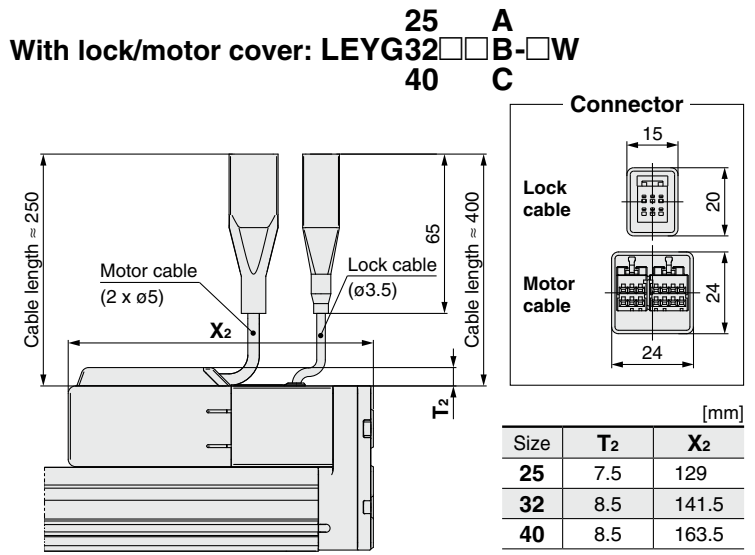
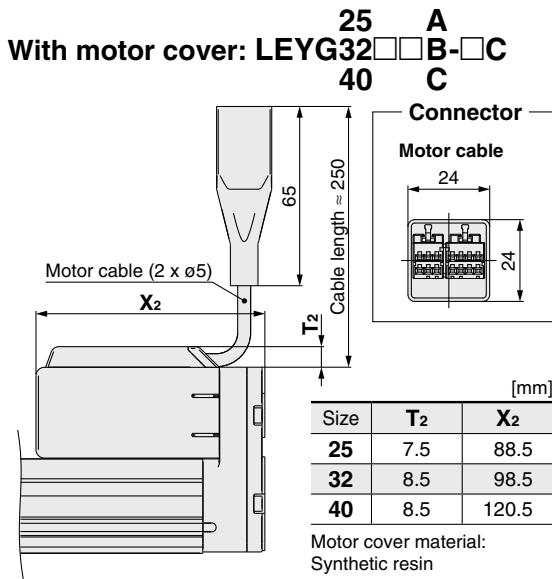

In-line motor type

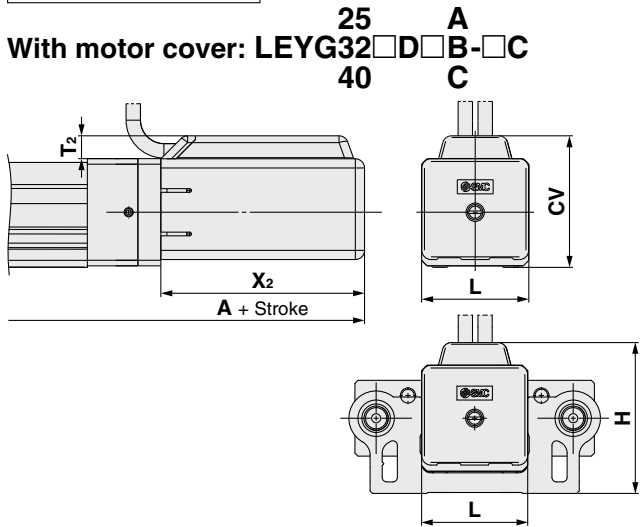

Size	Stroke range	A	T ₂	X ₂	L	H	CV
25	100st or less	209.5	7.5	68.5	46	61.3	54.5
	101st or more, 300st or less	234.5					
32	100st or less	232	8.5	73.5	60	76.8	69.5
	101st or more, 300st or less	262					
40	100st or less	254	8.5	95.5	60	76.8	69.5
	101st or more, 300st or less	284					

With lock/motor cover: LEYG32D□□B-□W
25 A
40 C

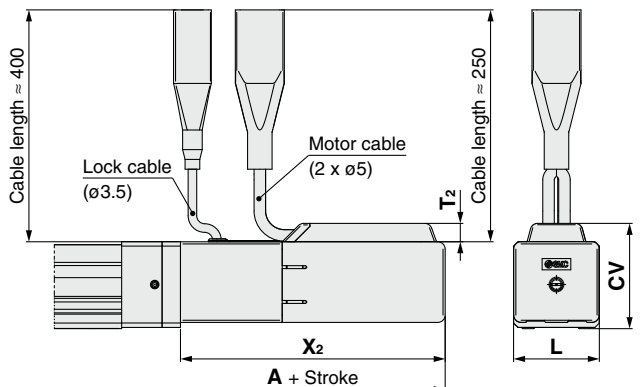

Size	Stroke range	A	T ₂	X ₂	L	H	CV
25	100st or less	250	7.5	109	46	61.3	54.4
	101st or more, 300st or less	275					
32	100st or less	275	8.5	116.5	60	76.8	69.5
	101st or more, 300st or less	305					
40	100st or less	297	8.5	138.5	60	76.8	69.5
	101st or more, 300st or less	327					

The connector size and motor height are different. Dimensions not listed are the same as those of the standard product.

LEFS
LEFB
LEY
LEYG
LES
LESH
LEHF
LER
JXC□1
JXC51/61

Battery-less Absolute Encoder: Electric Slide Table/ Compact Type

LES Series LES25



How to Order



Compact type

LES 25 R E J - 30 [] [] [] - R1 CD17T

1 2 3 4 5 6 7 8 9 10

For details on controllers, refer to the next page.

1 Size

25

2 Motor mounting position

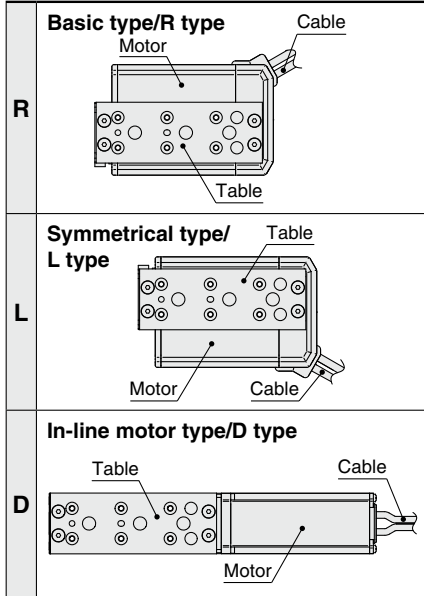

3 Motor type

E	Battery-less absolute (Step motor 24 VDC)
---	---

4 Lead [mm]

J	16
K	8

5 Stroke [mm]

Stroke	Applicable stroke
30 to 150	30*1, 50, 75, 100, 125, 150

6 Motor option

Nil	Without option
B	With lock

7 Body option

Nil	Without option
S	Dust-protected*2

8 Mounting*3

Symbol	Mounting	R type L type	D type
Nil	Without side holder	●	●
H	With side holder (4 pcs.)	—	●

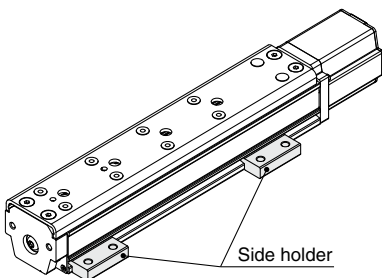

9 Actuator cable type/length

Robotic cable		[m]	
Nil	None	R8	8*4
R1	1.5	RA	10*4
R3	3	RB	15*4
R5	5	RC	20*4

Items not listed (specifications, dimensions, etc.) are the same as those of the standard product. For details, refer to the Web Catalog.

Battery-less Absolute Encoder: Electric Slide Table/Compact Type **LES Series**

⑩ Controller

Nil	Without controller
C□1□□	With controller

C D 1 7 T

Interface (Communication protocol/Input/Output)

E	EtherCAT®
9	EtherNet/IP™
P	PROFINET
D	DeviceNet™
L	IO-Link
M	CC-Link Ver. 1.10
5	Parallel input (NPN)
6	Parallel input (PNP)

Mounting

7	Screw mounting
8*5	DIN rail

• For single axis

Communication plug connector, I/O cable*6

Symbol	Type	Applicable interface
Nil	Without accessory	—
S	Straight type communication plug connector	DeviceNet™
T	T-branch type communication plug connector	CC-Link Ver. 1.10
1	I/O cable (1.5 m)	Parallel input (NPN) Parallel input (PNP)
3	I/O cable (3 m)	
5	I/O cable (5 m)	

- *1 R/L type with lock is not available.
- *2 For R/L type (IP5X equivalent), a scraper is mounted on the rod cover, and gaskets are mounted on both the end covers. For D type, a scraper is mounted on the rod cover.
- *3 For details, refer to the **Web Catalog**.
- *4 Produced upon receipt of order

- *5 The DIN rail is not included. Order it separately.
- *6 Select "Nil" for anything other than DeviceNet™, CC-Link, or parallel input.
Select "Nil," "S," or "T" for DeviceNet™ or CC-Link.
Select "Nil," "1," "3," or "5" for parallel input.

⚠ Caution

[CE-compliant products]

EMC compliance was tested by combining the electric actuator LES series and the controller JXC series.

The EMC depends on the configuration of the customer's control panel and the relationship with other electrical equipment and wiring. Therefore, compliance with the EMC directive cannot be certified for SMC components incorporated into the customer's equipment under actual operating conditions. As a result, it is necessary for the customer to verify compliance with the EMC directive for the machinery and equipment as a whole.

[Precautions relating to differences in controller versions]

When the JXC series is to be used in combination with the battery-less absolute encoder, use a controller that is version V3.4 or S3.4 or higher. For details, refer to page 45.

The actuator and controller are sold as a package.

Confirm that the combination of the controller and actuator is correct.

<Check the following before use.>

- *1 Check the actuator label for the model number. This number should match that of the controller.

LES25REJ-50

*1



- * Refer to the Operation Manual for using the products. Please download it via our website, <https://www.smcworld.com>

Type	EtherCAT® direct input type	EtherNet/IP™ direct input type	PROFINET direct input type	DeviceNet™ direct input type	IO-Link direct input type	CC-Link direct input type	Step data input type
Series	JXCE1	JXC91	JXCP1	JXCD1	JXCL1	JXCM1	JXC51 JXC61
Features	EtherCAT® direct input	EtherNet/IP™ direct input	PROFINET direct input	DeviceNet™ direct input	IO-Link direct input	CC-Link direct input	Parallel I/O
Compatible motor	Battery-less absolute (Step motor 24 VDC)						
Max. number of step data	64 points						
Power supply voltage	24 VDC						
Reference page	31						37

LEFS
LEFB
LEY
LEYG
LES
LESH
LEHF
LER
JXC□1
JXC51/61

Battery-less Absolute Encoder: Electric Slide Table/ High Rigidity Type *LESH Series* LESH25



High rigidity type

How to Order

LESH 25 **R** **E** **J** - **50** **□** **□** **□** - **R1** **CD17T**

1
2
3
4
5
6
7
8
9
10

For details on controllers, refer to the next page.

1 Size

25

2 Motor mounting position

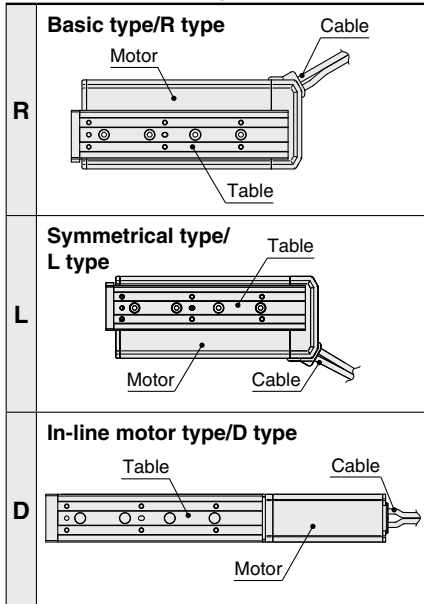

3 Motor type

E	Battery-less absolute (Step motor 24 VDC)
----------	--

4 Lead [mm]

J	16
K	8

5 Stroke [mm]

Stroke	Applicable stroke
50 to 150	50, 100, 150

6 Motor option

Nil	Without option
B	With lock

7 Body option

Nil	Without option
S	Dust-protected*1

8 Mounting*2

Symbol	Mounting	R type L type	D type
Nil	Without side holder	●	●
H	With side holder (4 pcs.)	—	●

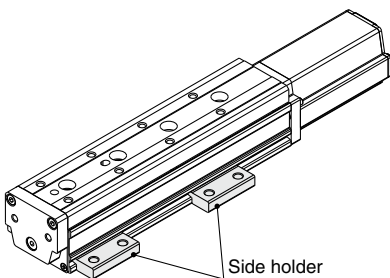

9 Actuator cable type/length

Robotic cable				[m]
Nil	None	R8		8*3
R1	1.5	RA		10*3
R3	3	RB		15*3
R5	5	RC		20*3

Items not listed (specifications, dimensions, etc.) are the same as those of the standard product. For details, refer to the Web Catalog.

Battery-less Absolute Encoder: Electric Slide Table/High Rigidity Type **LESH Series**

⑩ Controller

Nil	Without controller
C□1□□	With controller

C D 1 7 T

Interface (Communication protocol/Input/Output)

E	EtherCAT®
9	EtherNet/IP™
P	PROFINET
D	DeviceNet™
L	IO-Link
M	CC-Link Ver. 1.10
5	Parallel input (NPN)
6	Parallel input (PNP)

Mounting

7	Screw mounting
8*4	DIN rail

• For single axis

Communication plug connector, I/O cable*5

Symbol	Type	Applicable interface
Nil	Without accessory	—
S	Straight type communication plug connector	DeviceNet™
T	T-branch type communication plug connector	CC-Link Ver. 1.10
1	I/O cable (1.5 m)	Parallel input (NPN) Parallel input (PNP)
3	I/O cable (3 m)	
5	I/O cable (5 m)	

- *1 For R/L type (IP5X equivalent), a scraper is mounted on the rod cover, and gaskets are mounted on both the end covers. For D type, a scraper is mounted on the rod cover.
- *2 For details, refer to the **Web Catalog**.
- *3 Produced upon receipt of order

- *4 The DIN rail is not included. Order it separately.
- *5 Select "Nil" for anything other than DeviceNet™, CC-Link, or parallel input.
Select "Nil," "S," or "T" for DeviceNet™ or CC-Link.
Select "Nil," "1," "3," or "5" for parallel input.

⚠ Caution

[CE-compliant products]

EMC compliance was tested by combining the electric actuator LES series and the controller JXC series.

The EMC depends on the configuration of the customer's control panel and the relationship with other electrical equipment and wiring. Therefore, compliance with the EMC directive cannot be certified for SMC components incorporated into the customer's equipment under actual operating conditions. As a result, it is necessary for the customer to verify compliance with the EMC directive for the machinery and equipment as a whole.

[Precautions relating to differences in controller versions]

When the JXC series is to be used in combination with the battery-less absolute encoder, use a controller that is version V3.4 or S3.4 or higher. For details, refer to page 45.

The actuator and controller are sold as a package.

Confirm that the combination of the controller and actuator is correct.

<Check the following before use.>

- *1 Check the actuator label for the model number. This number should match that of the controller.

LESH25REJ-50

*1



- * Refer to the Operation Manual for using the products. Please download it via our website, <https://www.smcworld.com>

Type	EtherCAT® direct input type	EtherNet/IP™ direct input type	PROFINET direct input type	DeviceNet™ direct input type	IO-Link direct input type	CC-Link direct input type	Step data input type
Series	JXCE1	JXC91	JXCP1	JXCD1	JXCL1	JXCM1	JXC51 JXC61
Features	EtherCAT® direct input	EtherNet/IP™ direct input	PROFINET direct input	DeviceNet™ direct input	IO-Link direct input	CC-Link direct input	Parallel I/O
Compatible motor	Battery-less absolute (Step motor 24 VDC)						
Max. number of step data	64 points						
Power supply voltage	24 VDC						
Reference page	31						37

Battery-less Absolute Encoder: Electric Gripper 2-Finger Type

LEHF Series LEHF32, 40



How to Order

LEHF **32** **E** **K** **2** - **64** **□** - **R1** **CD17T**

① ② ③ ④ ⑤ ⑥ ⑦ ⑧

For details on controllers,
refer to the next page.

① Size

32
40

② Motor type

E	Battery-less absolute (Step motor 24 VDC)
----------	--

③ Lead

K	Basic
----------	-------

④ 2-finger type

⑤ Stroke [mm]

Stroke/both sides		Size
Basic	Long stroke	
32	64	32
40	80	40

⑥ Motor cable entry

Nil	Basic (Entry on the right side)	
	Entry on the left side	
L		

⑦ Actuator cable type/length

Robotic cable [m]			
Nil	None	R8	8*1
R1	1.5	RA	10*1
R3	3	RB	15*1
R5	5	RC	20*1

Items not listed (specifications, dimensions, etc.)
are the same as those of the standard product.
For details, refer to the Web Catalog.

8 Controller

Nil	Without controller
C□1□□	With controller

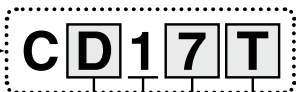

Interface (Communication protocol/Input/Output)

E	EtherCAT®
9	EtherNet/IP™
P	PROFINET
D	DeviceNet™
L	IO-Link
M	CC-Link Ver. 1.10
5	Parallel input (NPN)
6	Parallel input (PNP)

Mounting

7	Screw mounting
8*2	DIN rail

• For single axis

Communication plug connector, I/O cable*3

Symbol	Type	Applicable interface
Nil	Without accessory	—
S	Straight type communication plug connector	DeviceNet™ CC-Link Ver. 1.10
T	T-branch type communication plug connector	DeviceNet™ CC-Link Ver. 1.10
1	I/O cable (1.5 m)	Parallel input (NPN) Parallel input (PNP)
3	I/O cable (3 m)	Parallel input (NPN) Parallel input (PNP)
5	I/O cable (5 m)	Parallel input (NPN) Parallel input (PNP)

*1 Produced upon receipt of order

*2 The DIN rail is not included. Order it separately.

*3 Select "Nil" for anything other than DeviceNet™, CC-Link, or parallel input.

Select "Nil," "S," or "T" for DeviceNet™ or CC-Link.
Select "Nil," "1," "3," or "5" for parallel input.

Caution

[CE-compliant products]

EMC compliance was tested by combining the electric actuator LEH series and the controller JXC series.

The EMC depends on the configuration of the customer's control panel and the relationship with other electrical equipment and wiring. Therefore, compliance with the EMC directive cannot be certified for SMC components incorporated into the customer's equipment under actual operating conditions. As a result, it is necessary for the customer to verify compliance with the EMC directive for the machinery and equipment as a whole.

[Precautions relating to differences in controller versions]

When the JXC series is to be used in combination with the battery-less absolute encoder, use a controller that is version V3.4 or S3.4 or higher. For details, refer to page 45.

The actuator and controller are sold as a package.

Confirm that the combination of the controller and actuator is correct.

<Check the following before use.>

*1 Check the actuator label for the model number. This number should match that of the controller.

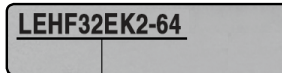

*1



* Refer to the Operation Manual for using the products. Please download it via our website, <https://www.smcworld.com>

Type	EtherCAT® direct input type	EtherNet/IP™ direct input type	PROFINET direct input type	DeviceNet™ direct input type	IO-Link direct input type	CC-Link direct input type	Step data input type
Series	JXCE1	JXC91	JXCP1	JXCD1	JXCL1	JXCM1	JXC51 JXC61
Features	EtherCAT® direct input	EtherNet/IP™ direct input	PROFINET direct input	DeviceNet™ direct input	IO-Link direct input	CC-Link direct input	Parallel I/O
Compatible motor	Battery-less absolute (Step motor 24 VDC)						
Max. number of step data	64 points						
Power supply voltage	24 VDC						
Reference page	31						37

LEFS
LEFB
LEY
LEYG
LES
LESH
LEHF
LER
JXC□1
JXC51/61

Battery-less Absolute Encoder: Electric Rotary Table

LER Series LER50



How to Order

LER 50 E K - - R1 CD17T

1
 2
 3
 4
 5
 6
 7
 8

For details on controllers,
refer to the next page.

1 Table accuracy

Nil	Basic type
H	High-precision type

2 Size

50

3 Motor type

E	Battery-less absolute (Step motor 24 VDC)
----------	--

4 Max. rotating torque [N·m]

K	High torque	10
J	Basic	6.6

5 Rotation angle [°]

Nil	320
2	External stopper: 180
3	External stopper: 90

6 Motor cable entry

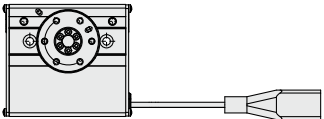
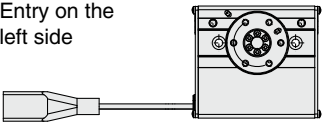
Nil	Basic type (entry on the right side)	
L	Entry on the left side	

7 Actuator cable type/length

Robotic cable				[m]
Nil	None	R8	8*1	
R1	1.5	RA	10*1	
R3	3	RB	15*1	
R5	5	RC	20*1	

Items not listed (specifications, dimensions, etc.)
are the same as those of the standard product.
For details, refer to the Web Catalog.

8 Controller

Nil	Without controller
C□1□□	With controller



Interface (Communication protocol/Input/Output)

E	EtherCAT®
9	EtherNet/IP™
P	PROFINET
D	DeviceNet™
L	IO-Link
M	CC-Link Ver. 1.10
5	Parallel input (NPN)
6	Parallel input (PNP)

Mounting

7	Screw mounting
8*2	DIN rail

For single axis

Communication plug connector, I/O cable*3

Symbol	Type	Applicable interface
Nil	Without accessory	—
S	Straight type communication plug connector	DeviceNet™ CC-Link Ver. 1.10
T	T-branch type communication plug connector	DeviceNet™ CC-Link Ver. 1.10
1	I/O cable (1.5 m)	Parallel input (NPN) Parallel input (PNP)
3	I/O cable (3 m)	Parallel input (NPN) Parallel input (PNP)
5	I/O cable (5 m)	Parallel input (NPN) Parallel input (PNP)

*1 Produced upon receipt of order

*2 The DIN rail is not included. Order it separately.

*3 Select "Nil" for anything other than DeviceNet™, CC-Link, or parallel input.

Select "Nil," "S," or "T" for DeviceNet™ or CC-Link.
Select "Nil," "1," "3," or "5" for parallel input.

Caution

[CE-compliant products]

EMC compliance was tested by combining the electric actuator LER series and the controller JXC series.

The EMC depends on the configuration of the customer's control panel and the relationship with other electrical equipment and wiring. Therefore, compliance with the EMC directive cannot be certified for SMC components incorporated into the customer's equipment under actual operating conditions. As a result, it is necessary for the customer to verify compliance with the EMC directive for the machinery and equipment as a whole.

[Precautions relating to differences in controller versions]

When the JXC series is to be used in combination with the battery-less absolute encoder, use a controller that is version V3.4 or S3.4 or higher. For details, refer to page 45.

The actuator and controller are sold as a package.

Confirm that the combination of the controller and actuator is correct.

<Check the following before use.>

*1 Check the actuator label for the model number. This number should match that of the controller.



*1



* Refer to the Operation Manual for using the products. Please download it via our website, <https://www.smcworld.com>

Type	EtherCAT® direct input type	EtherNet/IP™ direct input type	PROFINET direct input type	DeviceNet™ direct input type	IO-Link direct input type	CC-Link direct input type	Step data input type
Series	JXCE1	JXC91	JXCP1	JXCD1	JXCL1	JXCM1	JXC51 JXC61
Features	EtherCAT® direct input	EtherNet/IP™ direct input	PROFINET direct input	DeviceNet™ direct input	IO-Link direct input	CC-Link direct input	Parallel I/O
Compatible motor	Battery-less absolute (Step motor 24 VDC)						
Max. number of step data	64 points						
Power supply voltage	24 VDC						
Reference page	31						37

LEFS
LEFB
LEY
LEYG
LES
LESH
LEHF
LER
JXC□1
JXC51/61

Step Motor Controller

JXCE1/91/P1/D1/L1/M1 Series



How to Order

JXC **D** 1 **7** **T** -

Communication protocol

E	EtherCAT®
9	EtherNet/IP™
P	PROFINET
D	DeviceNet™
L	IO-Link
M	CC-Link

For single axis

Mounting

7	Screw mounting
8 *1	DIN rail

*1 The DIN rail is not included. It must be ordered separately. (Refer to page 36.)

Option

Nil	Without option
S	With straight type communication plug
T	With T-branch type communication plug

* Select "Nil" for anything other than JXCD1 and JXCM1.

Actuator part number

Without cable specifications and actuator options
Example: Enter "LEFS25EB-100" for the LEFS25EB-100B-R1□□.

BC-E Blank controller*1

*1 Requires dedicated software (JXC-BCW)



EtherCAT → EtherNet/IP PROFINET DeviceNet IO-Link CC-Link

The controller is sold as single unit after the compatible actuator is set.

Confirm that the combination of the controller and actuator is correct.

- ① Check the actuator label for the model number. This number should match that of the controller.

LEFS25EB-400

①



* Refer to the operation manual for using the products. Please download it via our website, <https://www.smcworld.com>

Precautions for blank controllers (JXC□1□□-BC-E)

A blank controller is a controller to which the customer can write the data of the actuator it is to be combined and used with. Use the dedicated software (JXC-BCW) for data writing.

- Please download the dedicated software (JXC-BCW) via our website.
- Order the controller setting kit (JXC-W2A-C) separately to use this software.

SMC website: <https://www.smcworld.com>

Step Motor Controller **JXCE1/91/P1/D1/L1/M1 Series**

Specifications

Model		JXCE1	JXC91	JXCP1	JXCD1	JXCL1	JXCM1	
Network		EtherCAT®	EtherNet/IP™	PROFINET	DeviceNet™	IO-Link	CC-Link	
Compatible motor		Step motor (Servo/24 VDC)						
Power supply		Power voltage: 24 VDC ±10%						
Current consumption (Controller)		200 mA or less	130 mA or less	200 mA or less	100 mA or less	100 mA or less	100 mA or less	
Compatible encoder		Battery-less absolute (4096 pulse/rotation)						
Communication specifications	Applicable system	Protocol	EtherCAT®*2	EtherNet/IP™*2	PROFINET*2	DeviceNet™	IO-Link	CC-Link
		Version*1	Conformance Test Record V.1.2.6	Volume 1 (Edition 3.14) Volume 2 (Edition 1.15)	Specification Version 2.32	Volume 1 (Edition 3.14) Volume 3 (Edition 1.13)	Version 1.1 Port Class A	Ver. 1.10
	Communication speed		100 Mbps*2	10/100 Mbps*2 (Automatic negotiation)	100 Mbps*2	125/250/500 kbps	230.4 kbps (COM3)	156 kbps, 625 kbps, 2.5 Mbps, 5 Mbps, 10 Mbps
	Configuration file*3		ESI file	EDS file	GSDML file	EDS file	IODD file	CSP+ file
	I/O occupation area		Input 20 bytes Output 36 bytes	Input 36 bytes Output 36 bytes	Input 36 bytes Output 36 bytes	Input 4, 10, 20 bytes Output 4, 12, 20, 36 bytes	Input 14 bytes Output 22 bytes	1 station, 2 stations, 4 stations
	Terminating resistor		Not included					
Memory		EEPROM						
LED indicator		PWR, RUN, ALM, ERR	PWR, ALM, MS, NS	PWR, ALM, SF, BF	PWR, ALM, MS, NS	PWR, ALM, COM	PWR, ALM, L ERR, L RUN	
Cable length [m]		Actuator cable: 20 or less						
Cooling system		Natural air cooling						
Operating temperature range [°C]		0 to 55 (No freezing)*4						
Operating humidity range [%RH]		90 or less (No condensation)						
Insulation resistance [MΩ]		Between all external terminals and the case: 50 (500 VDC)						
Weight [g]		220 (Screw mounting) 240 (DIN rail mounting)	210 (Screw mounting) 230 (DIN rail mounting)	220 (Screw mounting) 240 (DIN rail mounting)	210 (Screw mounting) 230 (DIN rail mounting)	190 (Screw mounting) 210 (DIN rail mounting)	170 (Screw mounting) 190 (DIN rail mounting)	

*1 Please note that versions are subject to change.

*2 Use a shielded communication cable with CAT5 or higher for the PROFINET, EtherNet/IP™, and EtherCAT®.

*3 The files can be downloaded from the SMC website.

*4 For the LEY40 and LEYG40 series, if the vertical work load is greater than the weight listed below, use the controller at an ambient temperature of 40°C or less.

Series	Weight [kg]	Series	Weight [kg]
LEY40□EA	9	LEYG40□EA	7
LEY40□EB	19	LEYG40□EB	17
LEY40□EC	38	LEYG40□EC	36

■ Trademark

EtherNet/IP™ is a trademark of ODVA.

DeviceNet™ is a trademark of ODVA.

EtherCAT® is registered trademark and patented technology, licensed by Beckhoff Automation GmbH, Germany.

LEFS

LEFB

LEY

LEYG

LES

LESH

LEHF

LER

JXC□1

JXC51/61

JXCE1/91/P1/D1/L1/M1 Series

Example of Operation Command

In addition to the step data input of 64 points maximum in each communication protocol, the changing of each parameter can be performed in real time via numerical data defined operation.

* Numerical values other than "Moving force," "Area 1," and "Area 2" can be used to perform operation under numerical instructions from JXCL1.

<Application example> Movement between 2 points

No.	Movement mode	Speed	Position	Acceleration	Deceleration	Pushing force	Trigger LV	Pushing speed	Moving force	Area 1	Area 2	In position
0	1: Absolute	100	10	3000	3000	0	0	0	100	0	0	0.50
1	1: Absolute	100	100	3000	3000	0	0	0	100	0	0	0.50

<Step no. defined operation>

Sequence 1: Servo ON instruction

Sequence 2: Instruction to return to origin

Sequence 3: Specify step data No. 0 to input the DRIVE signal.

Sequence 4: Specify step data No. 1 after the DRIVE signal has been temporarily turned OFF to input the DRIVE signal.

<Numerical data defined operation>

Sequence 1: Servo ON instruction

Sequence 2: Instruction to return to origin

Sequence 3: Specify step data No. 0 and turn ON the input instruction flag (position). Input 10 in the target position. Subsequently the start flag turns ON.

Sequence 4: Turn ON step data No. 0 and the input instruction flag (position) to change the target position to 100 while the start flag is ON.

The same operation can be performed with any operation command.

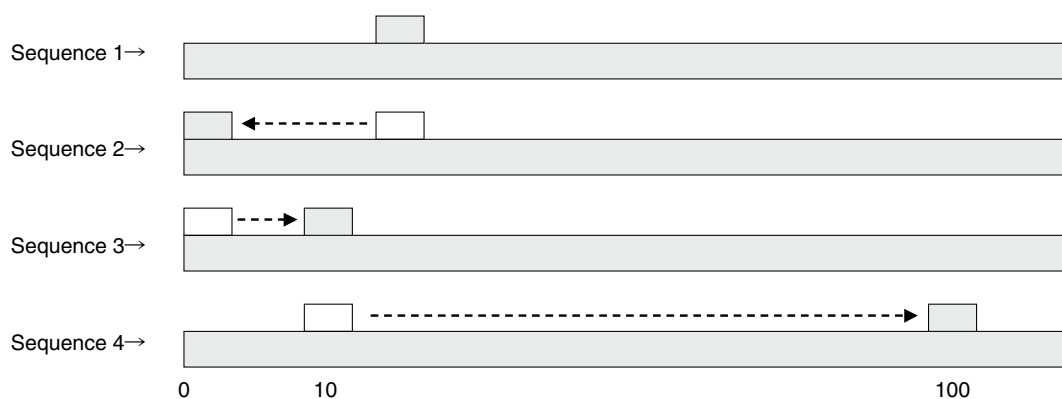

Dimensions

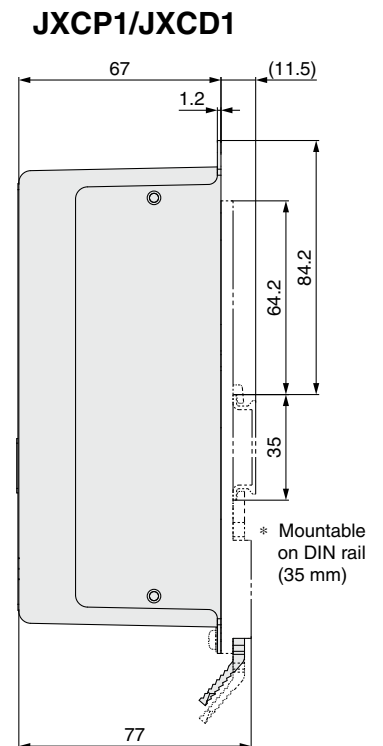
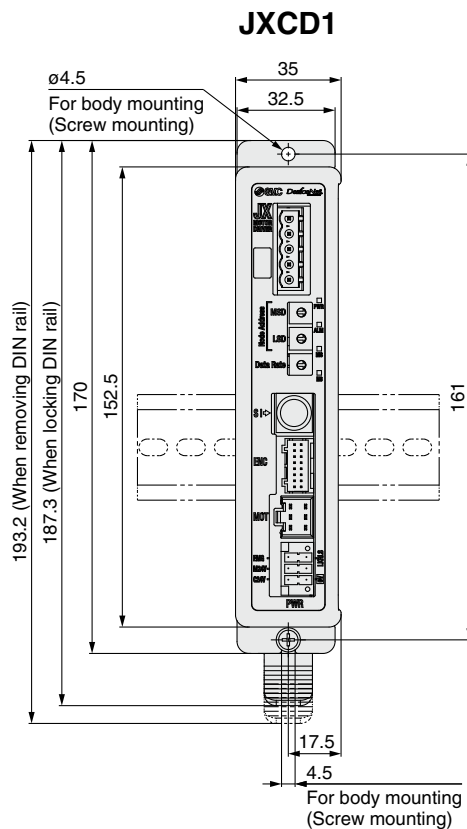
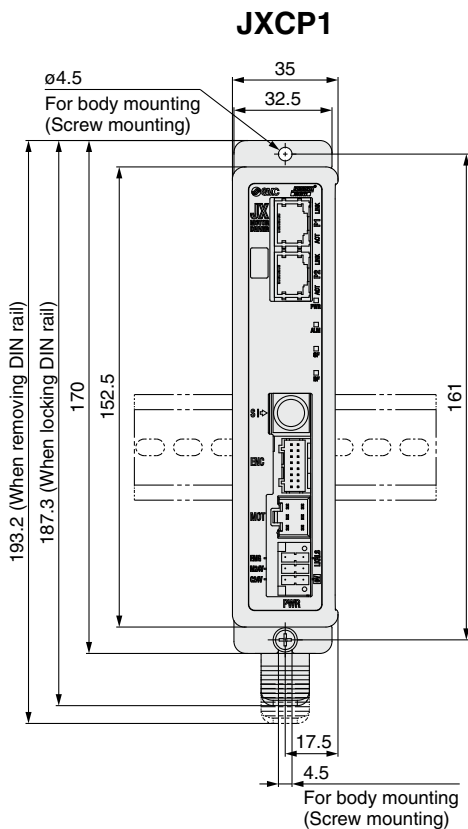
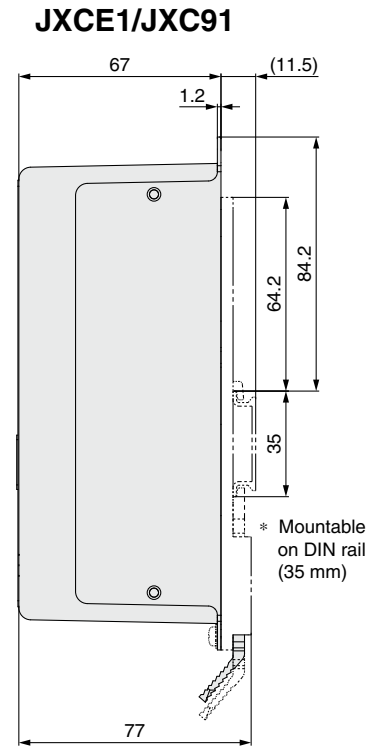
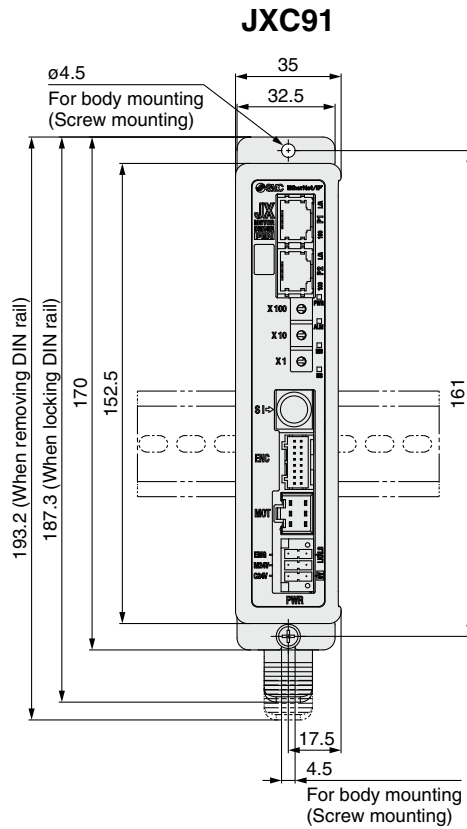
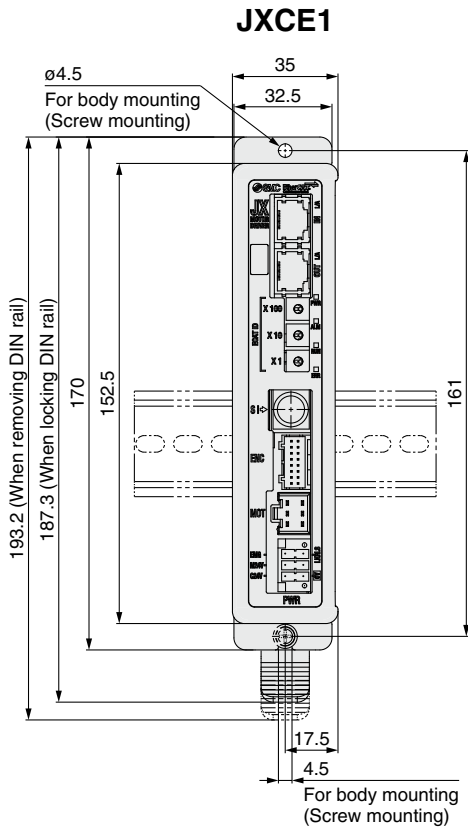

LEFS

LEFB

LEY

LEYG

LES

LESH

LEHF

LER

JXC□1

JXC51/61

JXCE1/91/P1/D1/L1/M1 Series

Dimensions

JXCL1

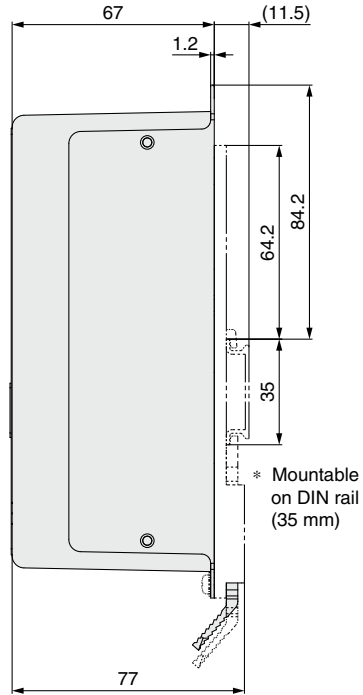
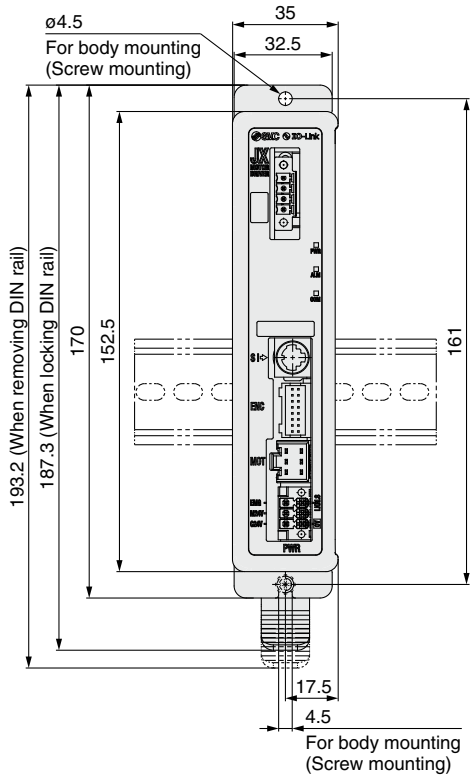

JXCM1

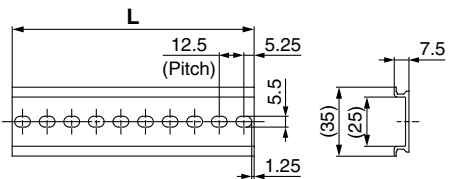
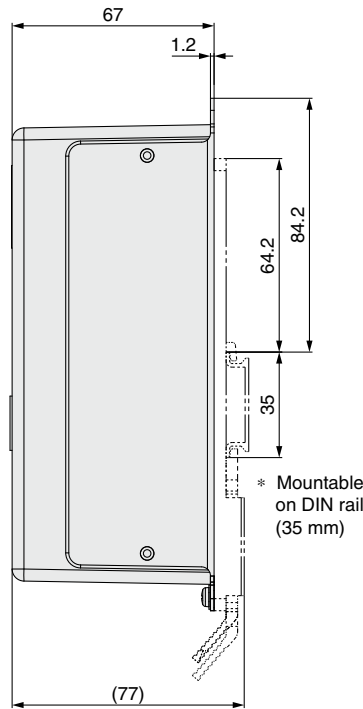
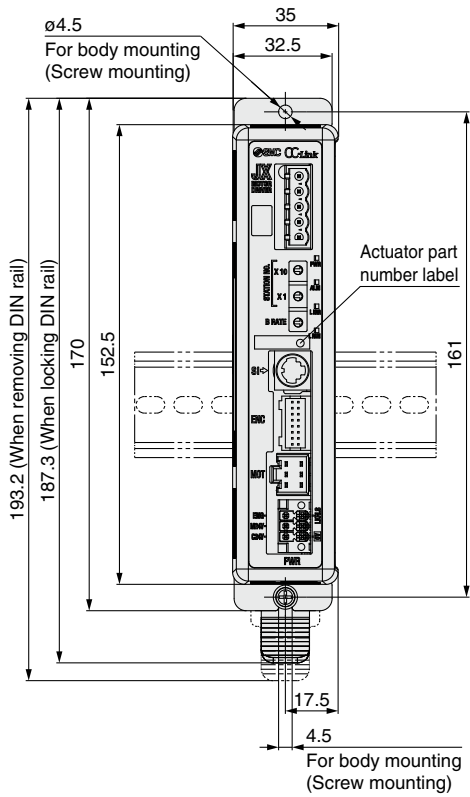

L Dimensions [mm]

No.	1	2	3	4	5	6	7	8	9	10	11	12	13	14	15	16	17	18	19	20
L	23	35.5	48	60.5	73	85.5	98	110.5	123	135.5	148	160.5	173	185.5	198	210.5	223	235.5	248	260.5
No.	21	22	23	24	25	26	27	28	29	30	31	32	33	34	35	36	37	38	39	40
L	273	285.5	298	310.5	323	335.5	348	360.5	373	385.5	398	410.5	423	435.5	448	460.5	473	485.5	498	510.5

Options

■ Communication cable for controller setting

- Controller setting software
 - USB driver
- Download from SMC's website:
<https://www.smcworld.com>

Hardware Requirements

OS	Windows®7, Windows®8.1, Windows®10
Communication interface	USB 1.1 or USB 2.0 ports
Display	1024 x 768 or more

* Windows®7, Windows®8.1, and Windows®10 are registered trademarks of Microsoft Corporation in the United States.

① Communication cable JXC-W2A-C

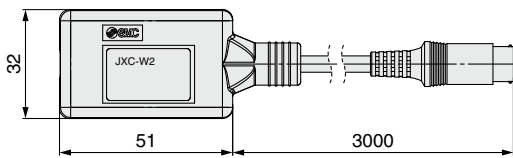

* It can be connected to the controller directly.

② USB cable LEC-W2-U

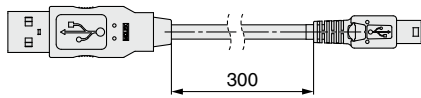

■ DIN rail mounting adapter LEC-3-D0

* With 2 mounting screws

This should be used when the DIN rail mounting adapter is mounted onto a screw mounting type controller afterward.

■ DIN rail AXT100-DR-□

* For □, enter a number from the No. line in the table on page 35. Refer to the dimension drawings on page 35 for the mounting dimensions.

■ Power supply plug JXC-CPW

* The power supply plug is an accessory.

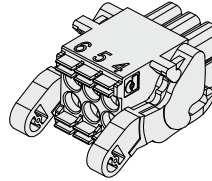

①	C24V	④	0V
②	M24V	⑤	N.C.
③	EMG	⑥	LK RLS

Power supply plug

Terminal name	Function	Details
0V	Common supply (-)	M24V terminal/C24V terminal/EMG terminal/LK RLS terminal are common (-).
M24V	Motor power supply (+)	Motor power supply (+) of the controller
C24V	Control power supply (+)	Control power supply (+) of the controller
EMG	Stop (+)	Connection terminal of the external stop circuit
LK RLS	Lock release (+)	Connection terminal of the lock release switch

■ Communication plug connector

For DeviceNet™

Straight type JXC-CD-S

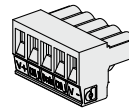

T-branch type JXC-CD-T

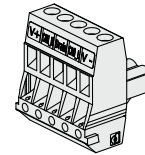

Communication plug connector for DeviceNet™

Terminal name	Details
V+	Power supply (+) for DeviceNet™
CAN_H	Communication wire (High)
Drain	Grounding wire/Shielded wire
CAN_L	Communication wire (Low)
V-	Power supply (-) for DeviceNet™

For IO-Link

Straight type JXC-CL-S

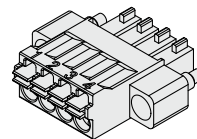

Communication plug connector for IO-Link

Terminal no.	Terminal name	Details
1	L+	+24 V
2	NC	N/A
3	L-	0 V
4	C/Q	IO-Link signal

For CC-Link

Straight type LEC-CMJ-S



T-branch type LEC-CMJ-T



Communication plug connector for CC-Link

Terminal name	Details
DA	CC-Link communication line A
DB	CC-Link communication line B
DG	CC-Link ground line
SLD	CC-Link shield
FG	Frame ground

■ Conversion cable P5062-5 (Cable length: 300 mm)

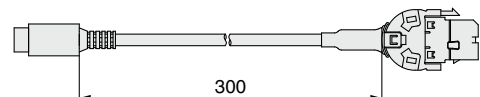

* To connect the teaching box (LEC-T1-3□G□) or controller setting kit (LEC-W2) to the controller, a conversion cable is required.

LEFS
LEFB
LEY
LEYG
LES
LESH
LEHF
LER
JXC□1
JXC51/61

Controller (Step Data Input Type) JXC51/61 Series



Parallel I/O

How to Order

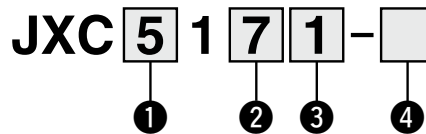

1 Parallel I/O type

5	NPN
6	PNP

2 Mounting

7	Screw mounting
8*1	DIN rail

*1 The DIN rail is not included. Order it separately.

3 I/O cable length [m]

Nil	None
1	1.5
3	3
5	5

4 Actuator part number

Without cable specifications and actuator options
Example: Enter "LEFS25EB-100" for the LEFS25EB-100B-R1□□.

BC-E Blank controller*1

*1 Requires dedicated software (JXC-BCW)

The controller is sold as single unit after the compatible actuator is set.

Confirm that the combination of the controller and actuator is correct.

<Check the following before use.>

- ① Check the actuator label for the model number. This number should match that of the controller.
- ② Check that the Parallel I/O configuration matches (NPN or PNP).

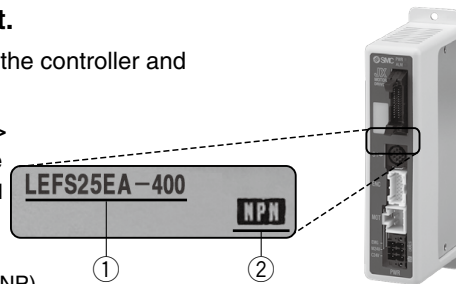

Precautions for blank controllers (JXC□1□□-BC-E)

A blank controller is a controller to which the customer can write the data of the actuator it is to be combined and used with. Use the dedicated software (JXC-BCW) for data writing.

- Please download the dedicated software (JXC-BCW) via our website.
- Order the communication cable for controller setting (JXC-W2A-C) separately to use this software.

SMC website
<https://www.smcworld.com>

* Refer to the operation manual for using the products. Please download it via our website, <https://www.smcworld.com>

Specifications

Model	JXC51 JXC61
Compatible motor	Step motor (Servo/24 VDC)
Power supply	Power voltage: 24 VDC ±10%
Current consumption (Controller)	100 mA or less
Compatible encoder	Battery-less absolute (4096 pulse/rotation)
Parallel input	11 inputs (Photo-coupler isolation)
Parallel output	13 outputs (Photo-coupler isolation)
Serial communication	RS485 (Only for the LEC-T1 and JXC-W2)
Memory	EEPROM
LED indicator	PWR, ALM
Cable length [m]	Actuator cable: 20 or less
Cooling system	Natural air cooling
Operating temperature range [°C]	0 to 55°C*1
Operating humidity range [%RH]	90 or less (No condensation)
Insulation resistance [MΩ]	Between all external terminals and the case: 50 (50 VDC)
Weight [g]	150 (Screw mounting), 170 (DIN rail mounting)

*1 For the LEY40 and LEYG40 series, if the vertical work load is greater than the weight listed below, use the controller at an ambient temperature of 40°C or less.

Series	Weight [kg]	Series	Weight [kg]
LEY40□EA	9	LEYG40□EA	7
LEY40□EB	19	LEYG40□EB	17
LEY40□EC	38	LEYG40□EC	36

How to Mount

a) Screw mounting (JXC□1□□-□) (Installation with two M4 screws)

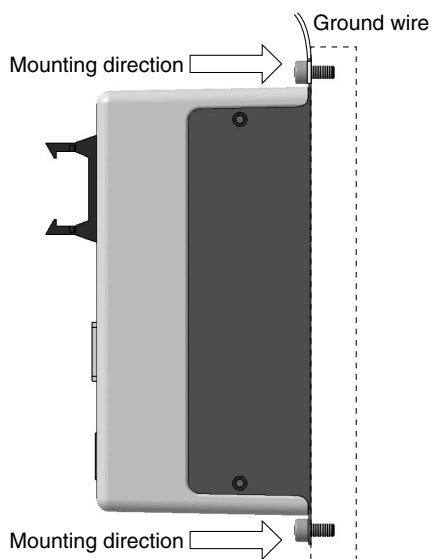

b) DIN rail mounting (JXC□1□□D-□) (Installation with the DIN rail)

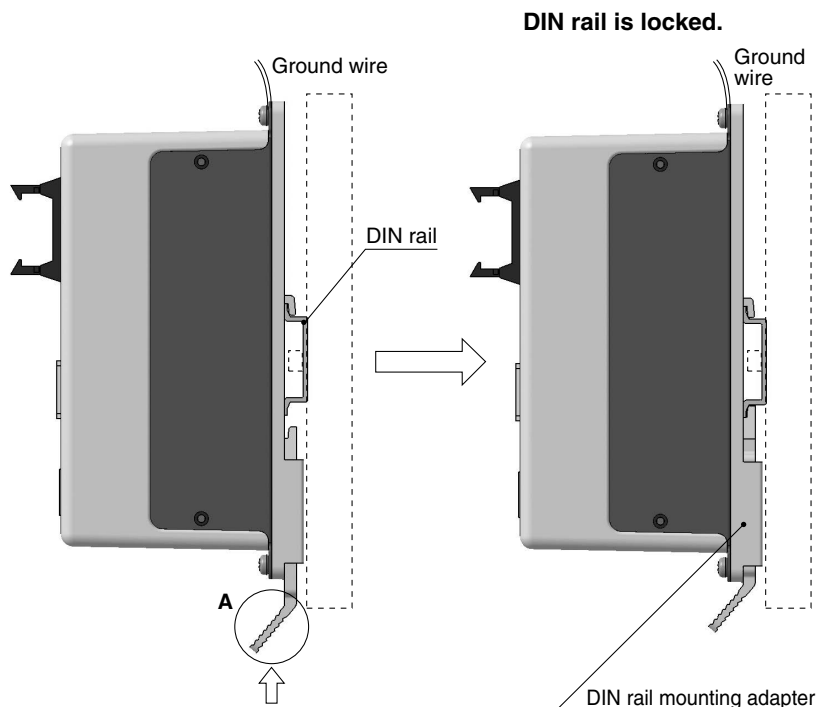

Hook the controller on the DIN rail and press the lever of section **A** in the arrow direction to lock it.

* When size 25 or more of the LE series are used, the space between the controllers should be 10 mm or more.

DIN rail AXT100-DR-□

* For □, enter a number from the No. line in the table below.
Refer to the dimension drawings on page 39 for the mounting dimensions.

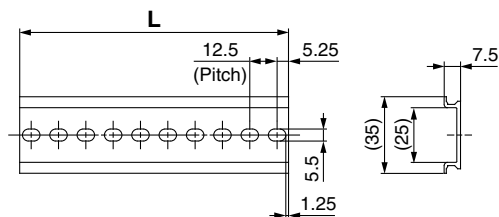

L Dimensions [mm]

No.	1	2	3	4	5	6	7	8	9	10	11	12	13	14	15	16	17	18	19	20
L	23	35.5	48	60.5	73	85.5	98	110.5	123	135.5	148	160.5	173	185.5	198	210.5	223	235.5	248	260.5
No.	21	22	23	24	25	26	27	28	29	30	31	32	33	34	35	36	37	38	39	40
L	273	285.5	298	310.5	323	335.5	348	360.5	373	385.5	398	410.5	423	435.5	448	460.5	473	485.5	498	510.5

DIN rail mounting adapter LEC-D0 (with 2 mounting screws)

This should be used when the DIN rail mounting adapter is mounted onto a screw mounting type controller afterward.

LEFS
LEFB
LEY
LEYG
LES
LESH
LEHF
LER
JXC□1
JXC51/61

JXC51/61 Series

Dimensions

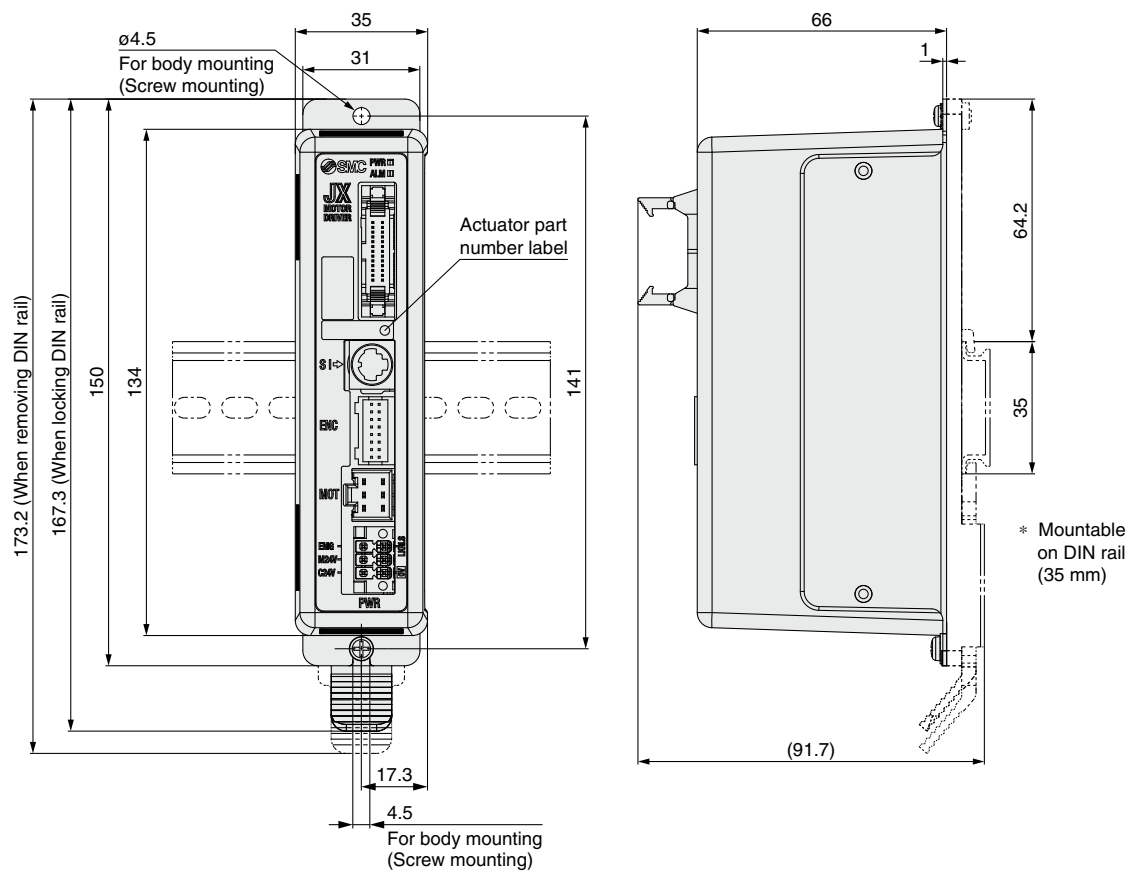

Wiring Example 1

Parallel I/O Connector

- * When you connect a PLC to the parallel I/O connector, use the I/O cable (LEC-CN5-□).
- * The wiring changes depending on the type of parallel I/O (NPN or PNP).

Wiring diagram

JXC51□□-□ (NPN)

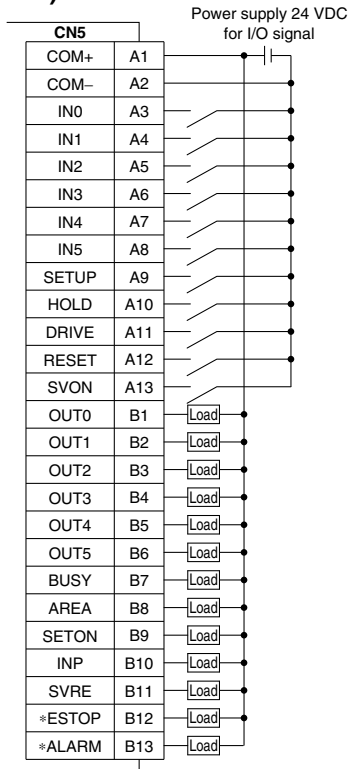

JXC61□□-□ (PNP)

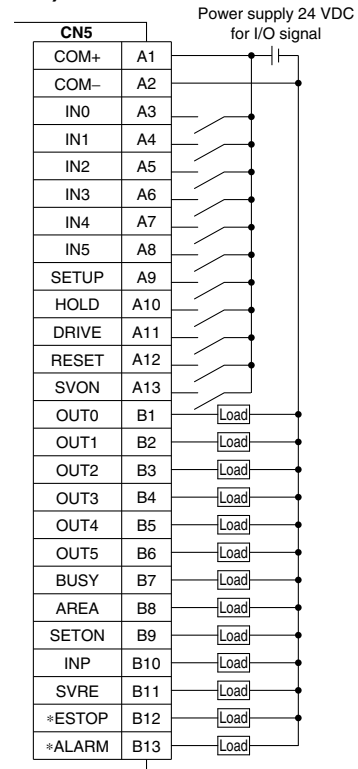

Input Signal

Name	Details
COM+	Connects the power supply 24 V for input/output signal
COM-	Connects the power supply 0 V for input/output signal
IN0 to IN5	Step data specified bit no. (Input is instructed by combining IN0 to 5.)
SETUP	Instruction to return to origin
HOLD	Temporarily stops operation
DRIVE	Instruction to drive
RESET	Resets alarm and interrupts operation
SVON	Servo ON instruction

Output Signal

Name	Details
OUT0 to OUT5	Outputs the step data no. during operation
BUSY	Outputs when the actuator is moving
AREA	Outputs within the step data area output setting range
SETON	Outputs when returning to origin
INP	Outputs when target position or target force is reached (Turns on when the positioning or pushing is completed.)
SVRE	Outputs when servo is on
ESTOP ¹	OFF when EMG stop is instructed
ALARM ¹	OFF when alarm is generated

*1 Signal of negative-logic circuit (N.C.)

LEFS

LEFB

LEY

LEYG

LES

LESH

LEHF

LER

JXC□1

JXC51/61

JXC51/61 Series

Step Data Setting

1. Step data setting for positioning

In this setting, the actuator moves toward and stops at the target position.

The following diagram shows the setting items and operation. The setting items and set values for this operation are stated below.

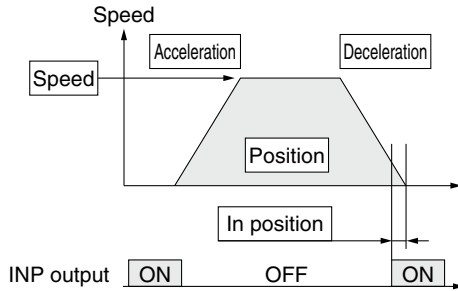

⊙ : Need to be set.
○ : Need to be adjusted as required.
— : Setting is not required.

Step Data (Positioning)

Necessity	Item	Details
⊙	Movement MOD	When the absolute position is required, set Absolute. When the relative position is required, set Relative.
⊙	Speed	Transfer speed to the target position
⊙	Position	Target position
○	Acceleration	Parameter which defines how rapidly the actuator reaches the speed set. The higher the set value, the faster it reaches the speed set.
○	Deceleration	Parameter which defines how rapidly the actuator comes to stop. The higher the set value, the quicker it stops.
⊙	Pushing force	Set 0. (If values 1 to 100 are set, the operation will be changed to the pushing operation.)
—	Trigger LV	Setting is not required.
—	Pushing speed	Setting is not required.
○	Moving force	Max. torque during the positioning operation (No specific change is required.)
○	Area 1, Area 2	Condition that turns on the AREA output signal.
○	In position	Condition that turns on the INP output signal. When the actuator enters the range of [in position], the INP output signal turns on. (It is unnecessary to change this from the initial value.) When it is necessary to output the arrival signal before the operation is completed, make the value larger.

2. Step data setting for pushing

The actuator moves toward the pushing start position, and when it reaches that position, it starts pushing with the set force or less.

The following diagram shows the setting items and operation. The setting items and set values for this operation are stated below.

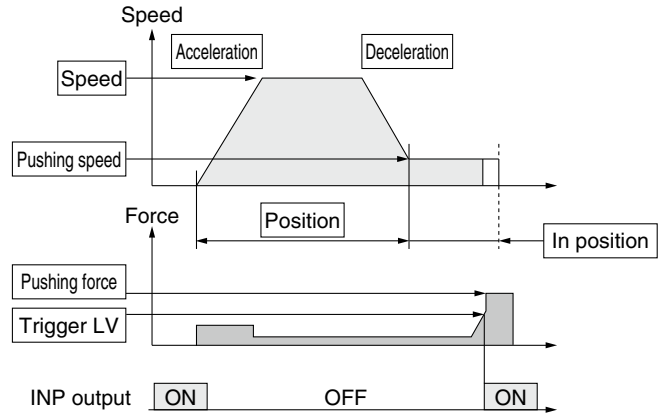

⊙ : Need to be set.
○ : Need to be adjusted as required.

Step Data (Pushing)

Necessity	Item	Details
⊙	Movement MOD	When the absolute position is required, set Absolute. When the relative position is required, set Relative.
⊙	Speed	Transfer speed to the pushing start position
⊙	Position	Pushing start position
○	Acceleration	Parameter which defines how rapidly the actuator reaches the speed set. The higher the set value, the faster it reaches the speed set.
○	Deceleration	Parameter which defines how rapidly the actuator comes to stop. The higher the set value, the quicker it stops.
⊙	Pushing force	Pushing force ratio is defined. The setting range differs depending on the electric actuator type. Refer to the operation manual for the electric actuator.
⊙	Trigger LV	Condition that turns on the INP output signal. The INP output signal turns on when the generated force exceeds the value. Trigger level should be the pushing force or less.
○	Pushing speed	Pushing speed during pushing. When the speed is set fast, the electric actuator and workpieces might be damaged due to the impact when they hit the end, so this set value should be smaller. Refer to the operation manual for the electric actuator.
○	Moving force	Max. torque during the positioning operation (No specific change is required.)
○	Area 1, Area 2	Condition that turns on the AREA output signal.
⊙	In position	Transfer distance during pushing. If the transferred distance exceeds the setting, it stops even if it is not pushing. If the transfer distance is exceeded, the INP output signal will not turn on.

Signal Timing

Return to Origin

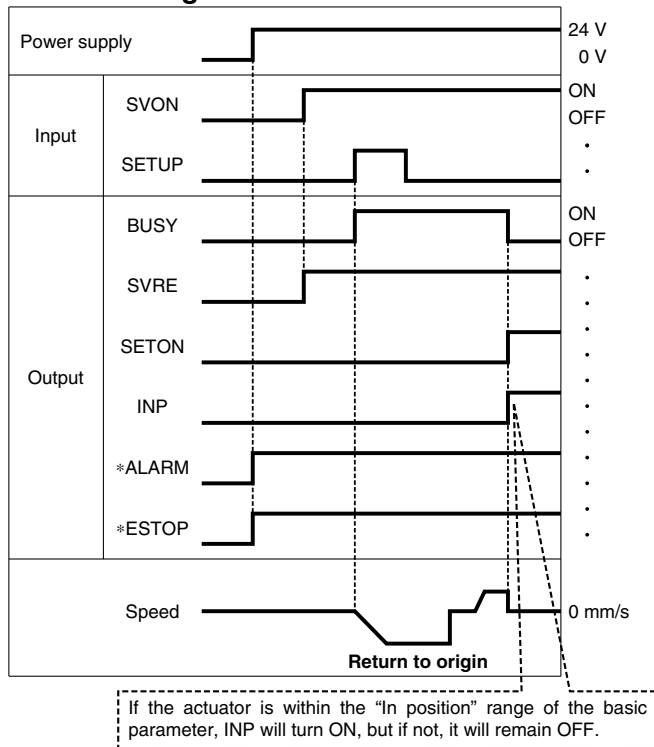

* *ALARM and *ESTOP are expressed as negative-logic circuits.

Positioning Operation

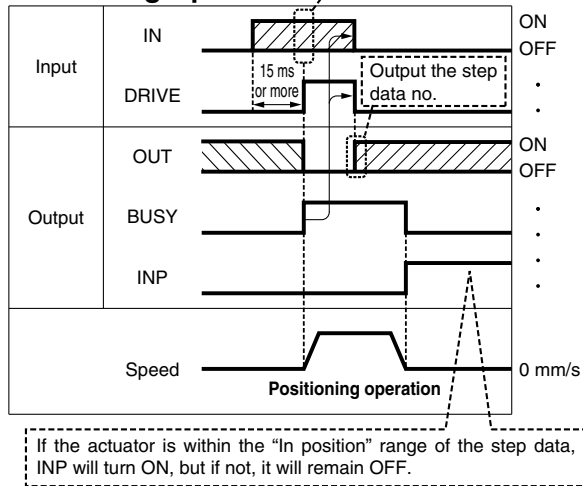

* "OUT" is output when "DRIVE" is changed from ON to OFF.
Refer to the operation manual for details on the controller for the LEM series.
(When power supply is applied, "DRIVE" or "RESET" is turned ON or *ESTOP is turned OFF, all of the "OUT" outputs are OFF.)

HOLD

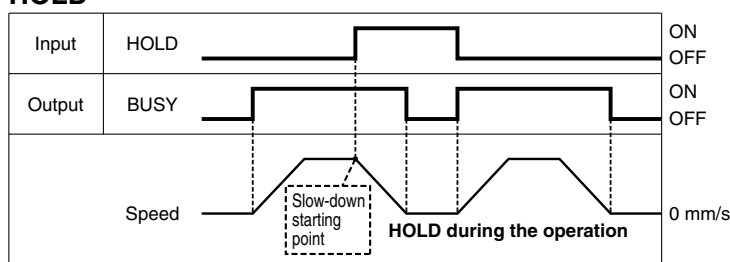

* When the actuator is within the "In position" range in the pushing operation, it does not stop even if HOLD signal is input.

Pushing Operation

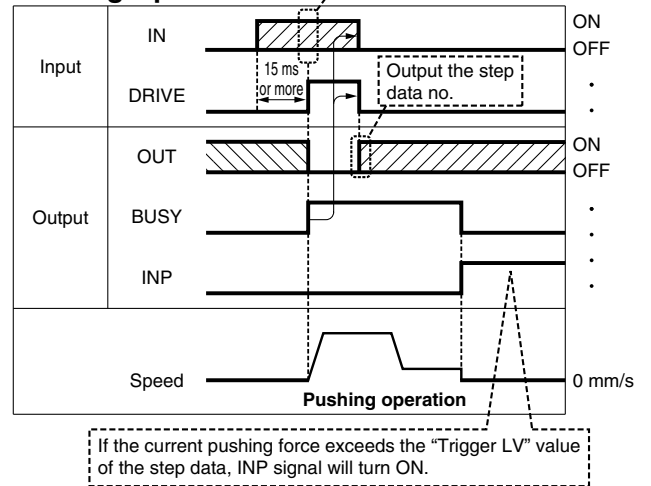

Reset

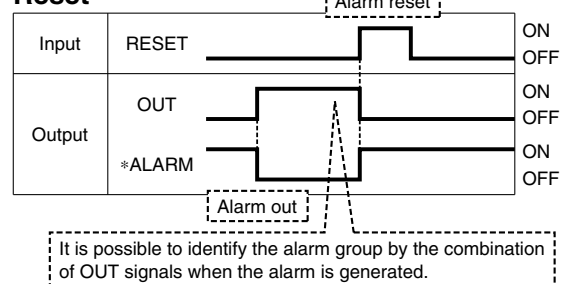

* *ALARM is expressed as a negative-logic circuit.

JXC51/61 Series

Options

Power supply plug JXC-CPW

- * The power supply plug is an accessory.
- <Applicable cable size> AWG20 (0.5 mm²), cover diameter 2.0 mm or less

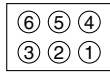
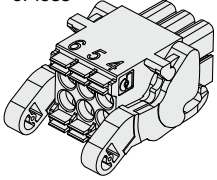

- ① C24V
- ② M24V
- ③ EMG
- ④ 0V
- ⑤ N.C.
- ⑥ LK RLS

Power supply plug terminal

Terminal name	Function	Details
0V	Common supply (-)	M24V terminal/C24V terminal/EMG terminal/LK RLS terminal are common (-).
M24V	Motor power supply (+)	Motor power supply (+) of the controller
C24V	Control power supply (+)	Control power supply (+) of the controller
EMG	Stop (+)	Connection terminal of the external stop circuit
LK RLS	Lock release (+)	Connection terminal of the lock release switch

Communication cable for controller setting

- Controller setting software
 - USB driver
- Download from SMC's website:
<https://www.smcworld.com>

Hardware Requirements

OS	Windows [®] 7, Windows [®] 8.1, Windows [®] 10
Communication interface	USB 1.1 or USB 2.0 ports
Display	1024 x 768 or more

- * Windows[®]7, Windows[®]8.1, and Windows[®]10 are registered trademarks of Microsoft Corporation in the United States.

① Communication cable JXC-W2A-C

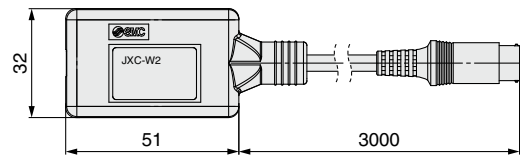

- * It can be connected to the controller directly.

② USB cable LEC-W2-U

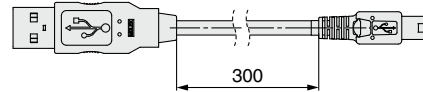

Conversion cable P5062-5 (Cable length: 300 mm)

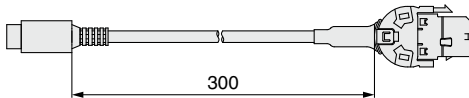

- * To connect the teaching box (LEC-T1-3□□□) to the controller, a conversion cable is required.

I/O cable

LEC-CN5-1

Cable length (L) [m]

1	1.5
3	3
5	5

- * Conductor size: AWG28

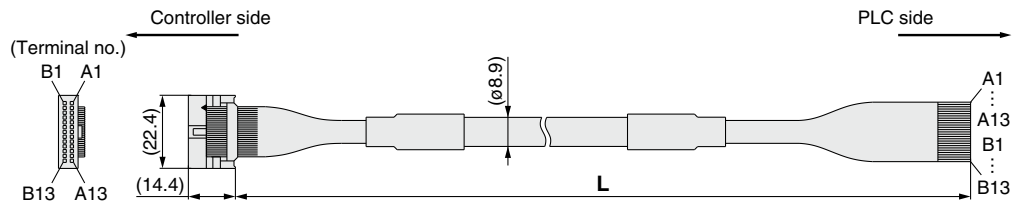

Connector pin no.	Insulation color	Dot mark	Dot color
A1	Light brown	■	Black
A2	Light brown	■	Red
A3	Yellow	■	Black
A4	Yellow	■	Red
A5	Light green	■	Black
A6	Light green	■	Red
A7	Gray	■	Black
A8	Gray	■	Red
A9	White	■	Black
A10	White	■	Red
A11	Light brown	■ ■	Black
A12	Light brown	■ ■	Red
A13	Yellow	■ ■	Black

Connector pin no.	Insulation color	Dot mark	Dot color
B1	Yellow	■ ■	Red
B2	Light green	■ ■	Black
B3	Light green	■ ■	Red
B4	Gray	■ ■	Black
B5	Gray	■ ■	Red
B6	White	■ ■	Black
B7	White	■ ■	Red
B8	Light brown	■ ■ ■	Black
B9	Light brown	■ ■ ■	Red
B10	Yellow	■ ■ ■	Black
B11	Yellow	■ ■ ■	Red
B12	Light green	■ ■ ■	Black
B13	Light green	■ ■ ■	Red
—			Shield

Weight

Product no.	Weight [g]
LEC-CN5-1	170
LEC-CN5-3	320
LEC-CN5-5	520

Step Motor Controller **JXCE1/91/P1/D1/L1/M1 Series** Controller (Step Data Input Type) **JXC51/61 Series**

Options: Actuator Cable

[Robotic cable for battery-less absolute (Step motor 24 VDC)]

LE-CE-1

Cable length (L) [m]

1	1.5
3	3
5	5
8	8*1
A	10*1
B	15*1
C	20*1

*1 Produced upon receipt of order

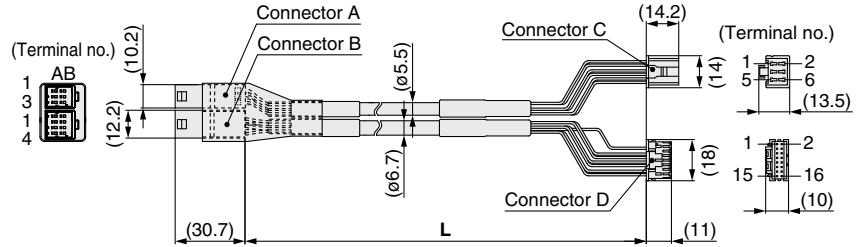

Weight

Product no.	Weight [g]	Note
LE-CE-1	190	Robotic cable
LE-CE-3	360	
LE-CE-5	570	
LE-CE-8	900	
LE-CE-A	1120	
LE-CE-B	1680	
LE-CE-C	2210	

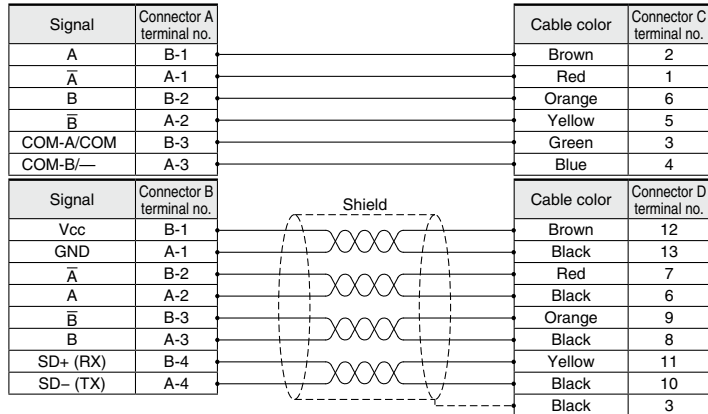

[Robotic cable with lock for battery-less absolute (Step motor 24 VDC)]

LE-CE-1-B

Cable length (L) [m]

1	1.5
3	3
5	5
8	8*1
A	10*1
B	15*1
C	20*1

*1 Produced upon receipt of order

With lock and sensor

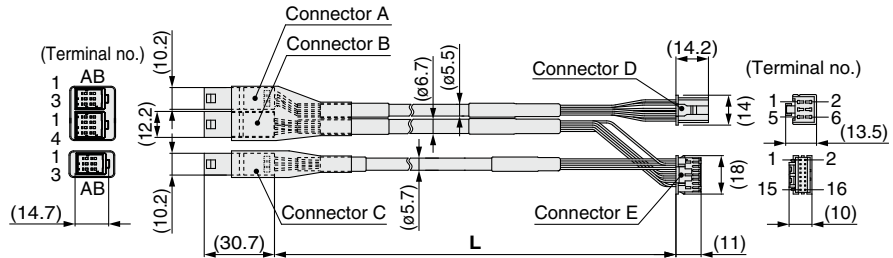

Weight

Product no.	Weight [g]	Note
LE-CE-1-B	240	Robotic cable
LE-CE-3-B	460	
LE-CE-5-B	740	
LE-CE-8-B	1170	
LE-CE-A-B	1460	
LE-CE-B-B	2120	
LE-CE-C-B	2890	

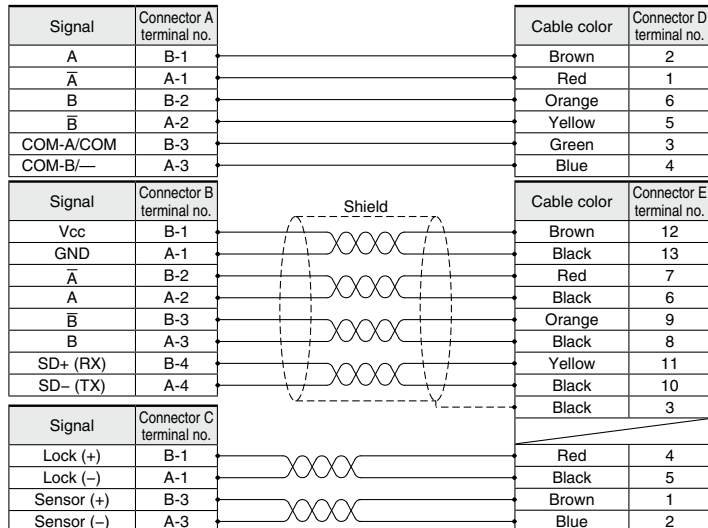

LEFS
LEFB
LEY
LEYG
LES
LESH
LEHF
LER
JXC□1
JXC51/61



JXCE1/91/P1/D1/L1/M1/51/61 Series Precautions Relating to Differences in Controller Versions

As the controller version of the JXC series differs, the internal parameters are not compatible.

- If using the JXC□1□-BC or JXC□1□-BC-E, please use the latest version of the JXC-BCW (parameter writing tool).
- There are currently 3 versions available: version 1 products (V1.□ or S1.□), version 2 products (V2.□ or S2.□), and version 3 products (V3.□ or S3.□). Keep in mind that in order to write a backup file (.bcp) to another controller with the JXC-BCW, it needs to be the same version as the controller that created the file. (For example, a backup file created by a version 1 product can only be written to another version 1 product, and so on.) A backup file for the electric actuator with battery-less absolute encoder can only be written between version 3.4 or higher product (the backup file of version 2 or earlier products cannot be written).

Identifying Version Symbols

JXC□1 Series Version V3.□ or S3.□ Products

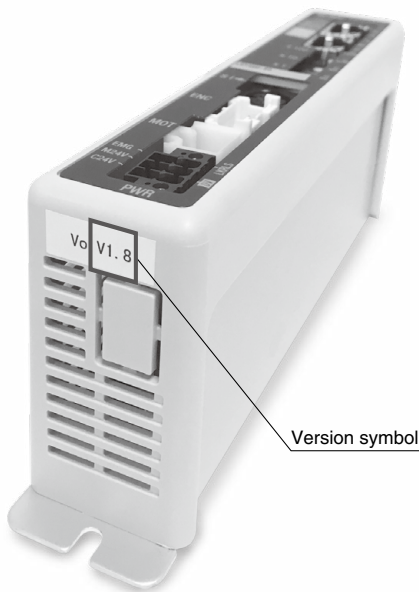

XR V3.0

Applicable models

JXC91□ Series

XR S3.0 T1.0

Applicable models

JXCD1□ Series
JXCE1□ Series
JXCP1□ Series
JXCL1□ Series
JXCM1□ Series
JXC51/61□ Series

JXC□1 Series Version V2.□ or S2.□ Products

WP V2.1

Applicable models

JXC91□ Series

WP S2.2 T1.1

Applicable models

JXCD1□ Series
JXCE1□ Series
JXCP1□ Series
JXCL1□ Series

JXC□1 Series Version V1.□ or S1.□ Products

XR V1.0

Applicable models

JXC91□ Series

XR S1.0 T1.0

Applicable models

JXCD1□ Series
JXCE1□ Series
JXCP1□ Series
JXCL1□ Series

■ Trademark

EtherNet/IP™ is a trademark of ODVA.

DeviceNet™ is a trademark of ODVA.

EtherCAT® is registered trademark and patented technology, licensed by Beckhoff Automation GmbH, Germany.



Electric Actuators with Battery-less Absolute Encoder Specific Product Precautions

Be sure to read this before handling the products. For safety instructions and electric actuator precautions, refer to the “Handling Precautions for SMC Products” and the “Operation Manual” on the SMC website: <https://www.smcworld.com>

Handling

⚠ Caution

1. Absolute encoder ID mismatch error at the first connection

When connecting the controller and actuator for the first time, an alarm “Absolute encoder ID does not match” always occurs. The actuator encoder ID number is registered to the controller by resetting the alarm and pairing is completed. If a different controller is connected after pairing, an alarm will be generated again. The actuator encoder ID number is registered to the controller by resetting the alarm and pairing is completed, but pairing is performed again by resetting the alarm.

When a controller is changed after pairing is completed				
	Encoder ID no. (* Numbers below are examples.)			
Actuator	17623	17623	17623	17623
Controller	17623	17699	17699	17623
ID mismatch error occurred?	No	Yes	Error reset ⇒ No	

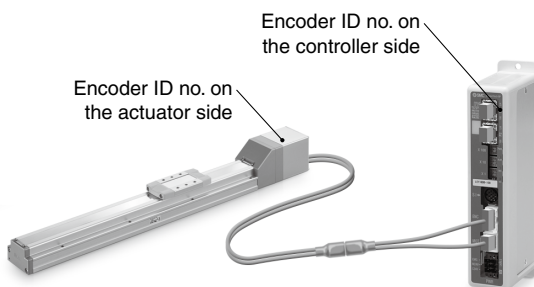

ID number is automatically checked when the control power supply is turned on. An error is output if the ID number does not match.

2. In strong magnetic field environments, some use is limited.

A magnetic sensor is used in the encoder. Therefore, if the actuator motor is used in a strong magnetic field environment, malfunction or failure may occur.

Do not expose the actuator motor to a magnetic field with a magnetic flux density of 1 mT or more.

When installing an electric actuator and an air cylinder with an auto switch (ex. CDQ2 series) or an electric actuators side by side, maintain of 40 mm or more around the motor. Refer to the construction drawing of the actuator motor.

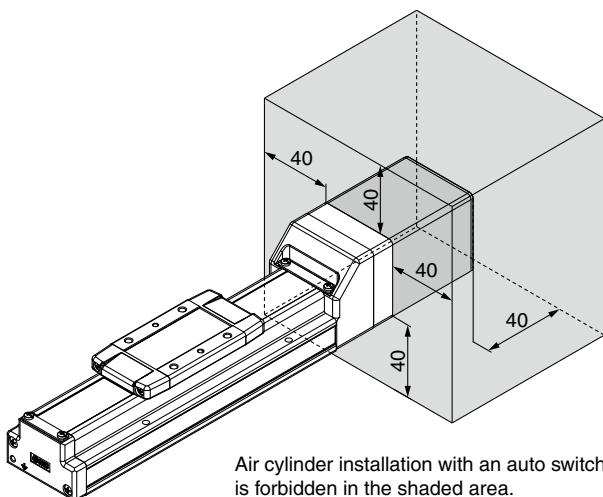

Air cylinder installation with an auto switch is forbidden in the shaded area.

• When lining up actuators

SMC actuators can be used with their motors adjacent to each other. However, for actuators with a built-in auto switch magnet (the LEY and LEF series), maintain a space of 40 mm or more between the motors and the position where the magnet passes. For the LEF series, the magnet is in the middle of the table, and for the LEY series, the magnet is in the piston portion. (Refer to the construction drawings in the catalog for details.)

○ Can be used with their motors adjacent to each other

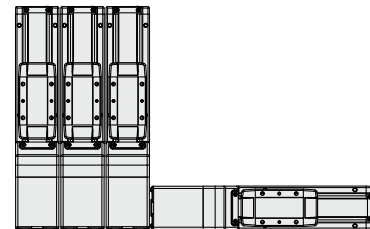

✗ Do not allow the motors to be in close proximity to the position where the magnet passes.

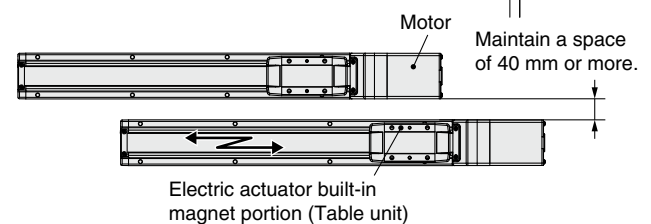
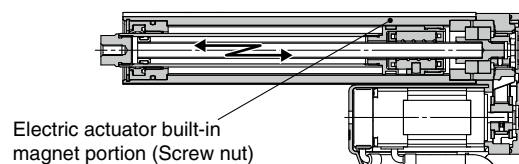

3. The connector size of the motor cable is different from that of the electric actuator with an incremental encoder.

The motor cable connector of an electric actuator with a battery-less absolute encoder is different from the electric actuator with an incremental encoder, connector cover dimensions are different. Take the dimensions below into design consideration.

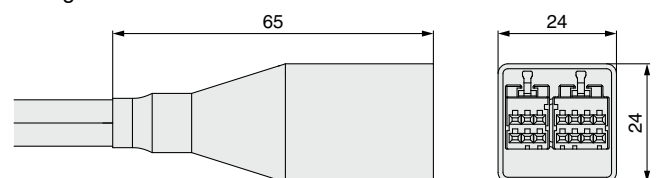



Battery-less absolute encoder connector cover dimensions

Safety Instructions

These safety instructions are intended to prevent hazardous situations and/or equipment damage. These instructions indicate the level of potential hazard with the labels of “**Caution**,” “**Warning**” or “**Danger**.” They are all important notes for safety and must be followed in addition to International Standards (ISO/IEC)*1), and other safety regulations.

 **Caution:** **Caution** indicates a hazard with a low level of risk which, if not avoided, could result in minor or moderate injury.

 **Warning:** **Warning** indicates a hazard with a medium level of risk which, if not avoided, could result in death or serious injury.

 **Danger:** **Danger** indicates a hazard with a high level of risk which, if not avoided, will result in death or serious injury.

*1) ISO 4414: Pneumatic fluid power – General rules relating to systems.
ISO 4413: Hydraulic fluid power – General rules relating to systems.
IEC 60204-1: Safety of machinery – Electrical equipment of machines.
(Part 1: General requirements)
ISO 10218-1: Manipulating industrial robots – Safety.
etc.

Warning

1. The compatibility of the product is the responsibility of the person who designs the equipment or decides its specifications.

Since the product specified here is used under various operating conditions, its compatibility with specific equipment must be decided by the person who designs the equipment or decides its specifications based on necessary analysis and test results. The expected performance and safety assurance of the equipment will be the responsibility of the person who has determined its compatibility with the product. This person should also continuously review all specifications of the product referring to its latest catalog information, with a view to giving due consideration to any possibility of equipment failure when configuring the equipment.

2. Only personnel with appropriate training should operate machinery and equipment.

The product specified here may become unsafe if handled incorrectly. The assembly, operation and maintenance of machines or equipment including our products must be performed by an operator who is appropriately trained and experienced.

3. Do not service or attempt to remove product and machinery/equipment until safety is confirmed.

1. The inspection and maintenance of machinery/equipment should only be performed after measures to prevent falling or runaway of the driven objects have been confirmed.
2. When the product is to be removed, confirm that the safety measures as mentioned above are implemented and the power from any appropriate source is cut, and read and understand the specific product precautions of all relevant products carefully.
3. Before machinery/equipment is restarted, take measures to prevent unexpected operation and malfunction.

4. Contact SMC beforehand and take special consideration of safety measures if the product is to be used in any of the following conditions.

1. Conditions and environments outside of the given specifications, or use outdoors or in a place exposed to direct sunlight.
2. Installation on equipment in conjunction with atomic energy, railways, air navigation, space, shipping, vehicles, military, medical treatment, combustion and recreation, or equipment in contact with food and beverages, emergency stop circuits, clutch and brake circuits in press applications, safety equipment or other applications unsuitable for the standard specifications described in the product catalog.
3. An application which could have negative effects on people, property, or animals requiring special safety analysis.
4. Use in an interlock circuit, which requires the provision of double interlock for possible failure by using a mechanical protective function, and periodical checks to confirm proper operation.

Caution

1. The product is provided for use in manufacturing industries.

The product herein described is basically provided for peaceful use in manufacturing industries.
If considering using the product in other industries, consult SMC beforehand and exchange specifications or a contract if necessary.
If anything is unclear, contact your nearest sales branch.

Limited warranty and Disclaimer/ Compliance Requirements

The product used is subject to the following “Limited warranty and Disclaimer” and “Compliance Requirements”.

Read and accept them before using the product.

Limited warranty and Disclaimer

1. The warranty period of the product is 1 year in service or 1.5 years after the product is delivered, whichever is first.*2)
Also, the product may have specified durability, running distance or replacement parts. Please consult your nearest sales branch.
2. For any failure or damage reported within the warranty period which is clearly our responsibility, a replacement product or necessary parts will be provided.
This limited warranty applies only to our product independently, and not to any other damage incurred due to the failure of the product.
3. Prior to using SMC products, please read and understand the warranty terms and disclaimers noted in the specified catalog for the particular products.

*2) Vacuum pads are excluded from this 1 year warranty.

A vacuum pad is a consumable part, so it is warranted for a year after it is delivered.
Also, even within the warranty period, the wear of a product due to the use of the vacuum pad or failure due to the deterioration of rubber material are not covered by the limited warranty.

Compliance Requirements

1. The use of SMC products with production equipment for the manufacture of weapons of mass destruction (WMD) or any other weapon is strictly prohibited.
2. The exports of SMC products or technology from one country to another are governed by the relevant security laws and regulations of the countries involved in the transaction. Prior to the shipment of a SMC product to another country, assure that all local rules governing that export are known and followed.

Caution

SMC products are not intended for use as instruments for legal metrology.

Measurement instruments that SMC manufactures or sells have not been qualified by type approval tests relevant to the metrology (measurement) laws of each country. Therefore, SMC products cannot be used for business or certification ordained by the metrology (measurement) laws of each country.

Safety Instructions

Be sure to read the “Handling Precautions for SMC Products” (M-E03-3) and “Operation Manual” before use.