

# 5 Port Solenoid Valve

## VQ1000/2000 Series

Metal Seal

Rubber Seal



Power saving

Standard: **0.4 w**

(Reduced by **60%** compared to current model)

High-pressure (1 MPa, Metal seal): **0.95 w**

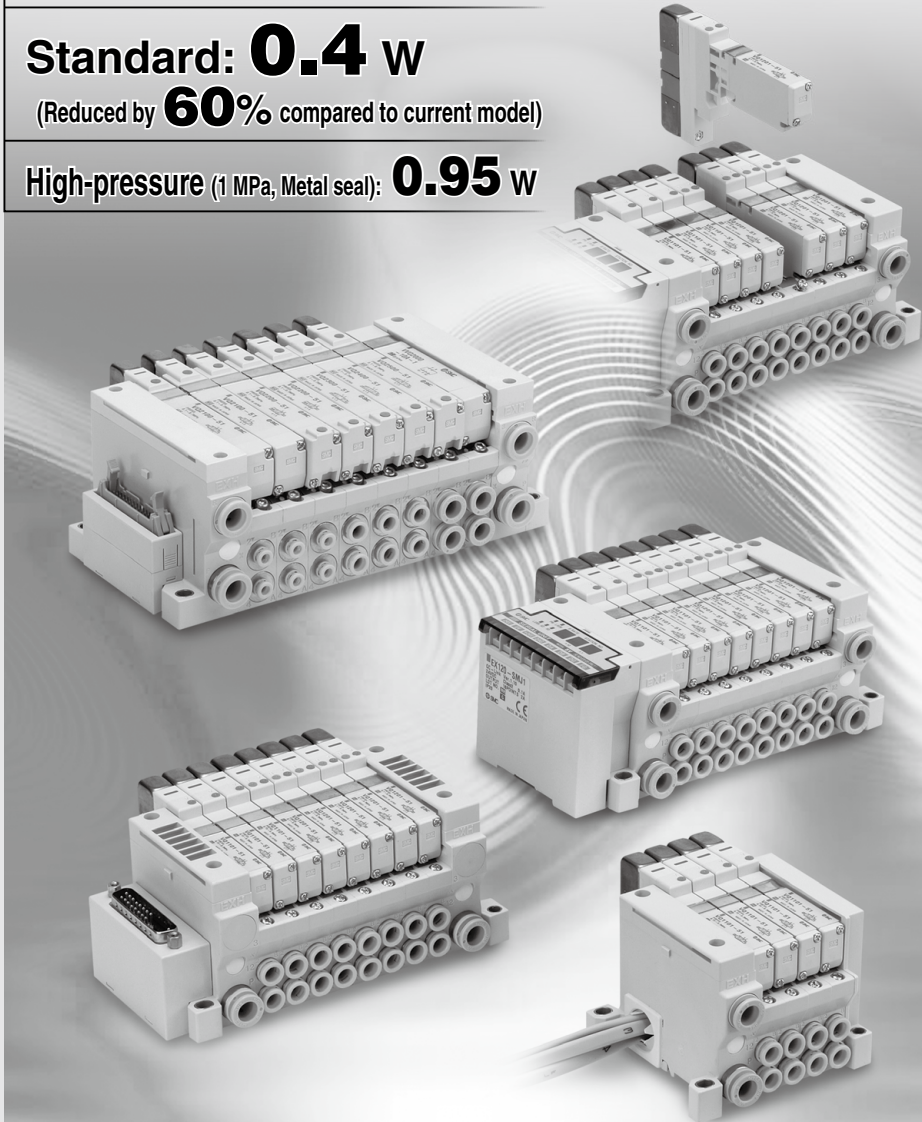

- SV
- SYJ
- SZ
- VF
- VP4
- VQ 1/2
- VQ 4/5
- VQC 1/2
- VQC 4/5
- VQZ
- SQ
- VFS
- VFR
- VQ7

# 5 Port Solenoid Valve VQ Series

## Space-saving profile

All pilot valves are compactly mounted on one side. The space-saving design of mounting all fittings on one side permits mounting in three directions.

## The non-bias, one-clamp structure permits easy valve replacement.

## Built-in One-touch fittings for easy piping

## Slide locking type manual override provided

ON/OFF operation and locking can be made by sliding the manual override.

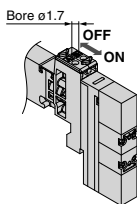

\* VQ1000

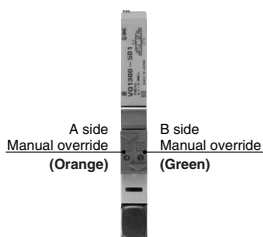

## Thin compact design with high flow capacity

Model	Manifold pitch (mm)	Flow rate characteristics		Applicable cylinder bore size
		Metal seal	Rubber seal	
		C [dm <sup>3</sup> /(s·bar)]	C [dm <sup>3</sup> /(s·bar)]	
VQ1000	10.5	0.72	1.0	Up to $\phi 50$
VQ2000	16	2.6	3.2	Up to $\phi 80$

\* Flow rate characteristics: 4/2 → 5/3 (A/B → R1/R2)

## A wide variety of optional parts

\* The photo does not show an actual use example.

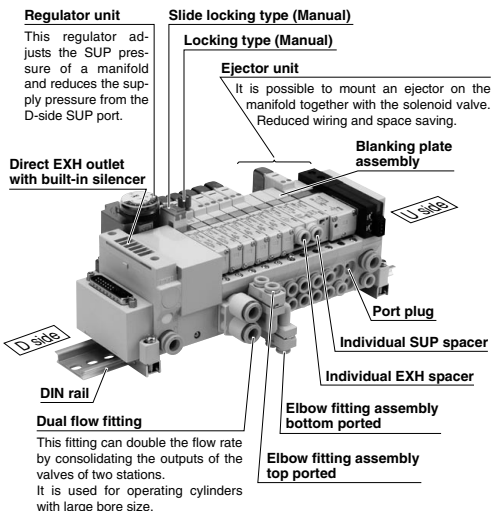

## Valve Specifications

Base Mounted	Plug-in	Sonic conductance C [dm <sup>3</sup> /(s·bar)] 4/2 → 5/3 (A/B → R1/R2)	Type of actuation	Voltage	Electrical entry	Manual override	Double		3-position													
							Single		3-position (Closed center)		Closed center		Exhaust center		Pressure center							
							Double	Single	Double	Single	Double	Single	Double	Single	Double	Single						
VQ1000 Series	P. 372	Metal seal	Single	12 VDC	Plug-in	Grommet	L-type plug connector	M-type plug connector	Non-locking push type (Tool required)	Locking type (Tool required)	Locking type (Manual)	Slide locking type (Manual)	0.72	0.72	●	●	●	●	●	●	●	●
		Rubber seal											1.0	0.65	●	●	●	●	●	●	●	●
	P. 376	Metal seal	Double	24 VDC	Grommet	L-type plug connector	M-type plug connector	Non-locking push type (Tool required)	Locking type (Tool required)	Locking type (Manual)	Slide locking type (Manual)	2.6	2.0	●	●	●	●	●	●	●	●	
		Rubber seal										3.2	2.2	●	●	●	●	●	●	●	●	●









P. 380

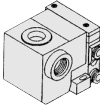

VQ1000 Series

VQ2000 Series

**A variety of common wiring methods are standardized.**

<p><b>F</b> kit (D-sub connector) Number of pins: 15/25</p>  <p>Top entry</p>  <p>Side entry</p>	<p><b>P</b> kit (Flat ribbon cable) Number of pins: 10/16/20/26</p>  <p>Top entry</p>  <p>Side entry</p>		
<p><b>T</b> kit (Terminal block box)</p> 	<p><b>L</b> kit (Lead wire)</p> 	<p><b>S</b> kit (Serial transmission)</p> 	<p><b>M</b> kit (Circular connector) (VQ2000 only)</p> 

**Dual 3-port valves, 4 positions**

Rubber seal only

- Two 3-port valves built into one body.
- The 3-port valves on the A and B sides can operate independently.
- When used as 3 port valves, only half the number of stations is required.
- Can also be used as a 4-position, 5-port type valve.

Exhaust center : **VQ1A01**  
                      : **VQ2A01**  
Pressure center : **VQ1B01**  
                      : **VQ2B01**

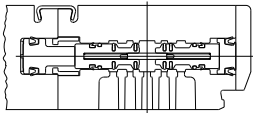

R1 A P B R2

Model	A side	B side	Symbol
VQ1A01 VQ2A01	N.C. valve	N.C. valve	
VQ1B01 VQ2B01	N.O. valve	N.O. valve	
VQ1C01 VQ2C01	N.C. valve	N.O. valve	

SV  
SYJ  
SZ  
VF  
VP4  
VQ 1/2  
VQ 4/5  
VQC 1/2  
VQC 4/5  
VQZ  
SQ  
VFS  
VFR  
VQ7

Semi-standard						Options													
External pilot	D-sub connector 15P	Flat ribbon cable 10P/16P/20P	Negative COM specifications	Inch-size One-touch fittings	Special wiring specifications	Blanking plate	Individual SUP/EXH spacer	SUP/EXH block plate	Name plate	Back pressure check valve	DIN rail mounting	Built-in silencer	Silencer for EXH port	Elbow fitting for cylinder port	Dual flow fitting	Plug for cylinder port	Regulator unit	Ejector unit	Double check block (Separated)
●	●	●	Except S kit	●	Except L kit	●	●	●	●	●	●	●	●	●	●	●	●	●	●
P. 418						P. 428													
●	●	●	Except S kit	●	Except L kit	●	●	●	●	●	●	●	●	●	●	●	●	●	●
P. 418						P. 434													

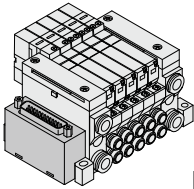
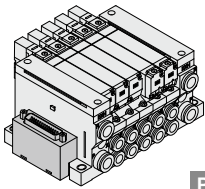
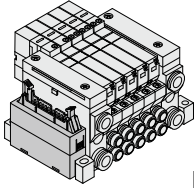
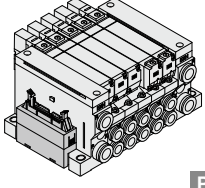
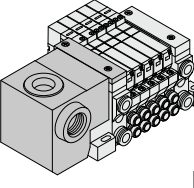
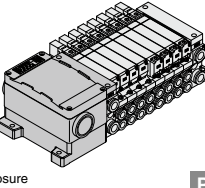
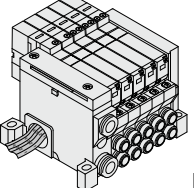
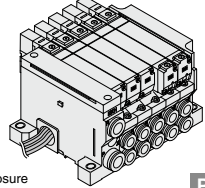

# VQ Series/Base Mounted: Variations

## Manifold Variations

		Plug-in		
		VQ1000 Series	VQ2000 Series	
<b>F</b> kit	<b>D-sub connector</b> Conforming to with MIL D-sub connector	 P. 382	 P. 382	
	<b>P</b> kit	<b>Flat ribbon cable (26/20/16/10 pins)</b> Conforming to MIL flat ribbon cable connector	 P. 386	 P. 386
	<b>T</b> kit	<b>Terminal block box (Terminal block)</b> Terminal block is compactly arranged on one side.	 P. 398	 IP65 enclosure compatible P. 398
	<b>L</b> kit	<b>Lead wire</b> Direct electrical entry type	 P. 402	 IP65 enclosure compatible P. 402

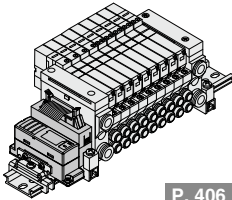
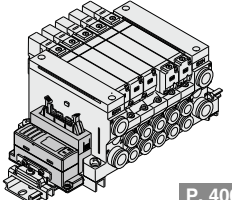
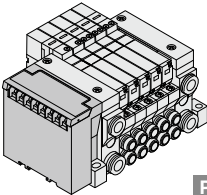
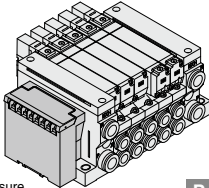

## Manifold Variations

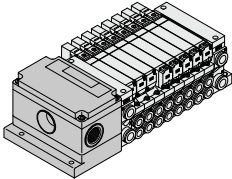
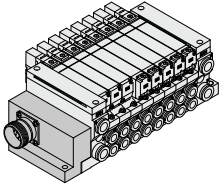
		Plug-in	
		VQ1000 Series	VQ2000 Series
<b>Gateway-type serial transmission system</b> Serial unit: EX510		 IP20 enclosure compliant <b>P. 406</b>	 IP20 enclosure compliant <b>P. 406</b>
	<b>Integrated-type serial transmission system (for Output)</b> <b>S</b> kit Serial unit: EX120/123/124	 <b>P. 410</b>	 IP20 enclosure compliant <b>P. 410</b>
<b>Circular connector</b> <b>M</b> kit IP65 (Dust-tight, Water-jet-proof "-W")	 	 Dust-tight, Water-jet-proof (-W) IP65 enclosure compliant <b>P. 410</b>	 Dust-tight, Water-jet-proof (-W) IP65 enclosure compliant <b>P. 414</b>

<b>SV</b>
<b>SYJ</b>
<b>SZ</b>
<b>VF</b>
<b>VP4</b>
<b>VQ 1/2</b>
<b>VQ 4/5</b>
<b>VQC 1/2</b>
<b>VQC 4/5</b>
<b>VQZ</b>
<b>SQ</b>
<b>VFS</b>
<b>VFR</b>
<b>VQ7</b>

# Cylinder Speed Chart

This chart is provided as guidelines only.  
For performance under various conditions, use SMC's Model Selection Program before making a judgment.

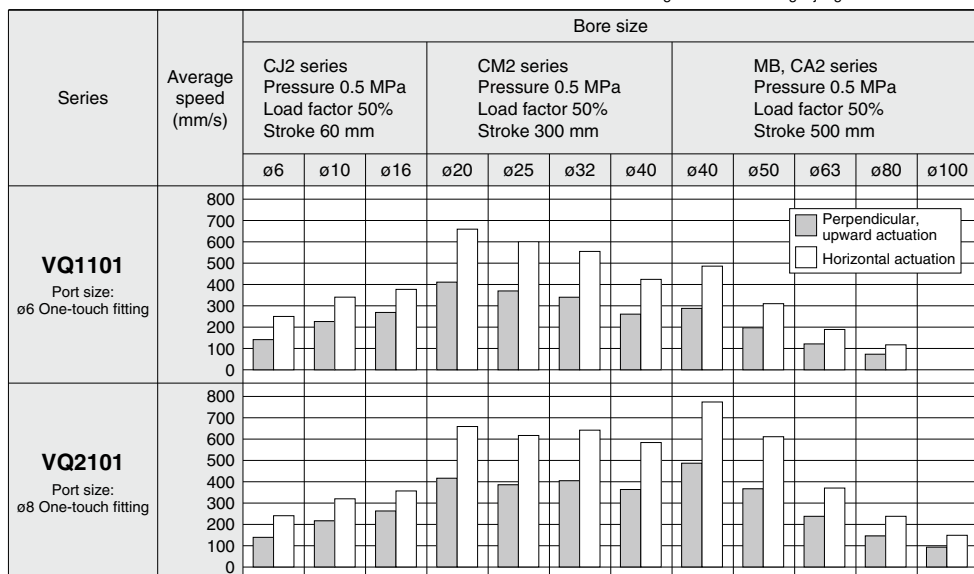

\* It is when the cylinder is extending that is meter-out controlled by speed controller which is directly connected with cylinder, and its needle valve with being fully open.

\* The average velocity of the cylinder is what the stroke is divided by the total stroke time.

\* Load factor: ((Load mass x 9.8)/Theoretical force) x 100%

## Conditions

Series	Conditions	CJ2 series	CM2 series	MB, CA2 series
<b>VQ1101</b>	Tube bore x Length	T0604 (O.D. ø6/I.D. ø4) x 1 m		
	Speed controller	AS3002F-06		
	Silencer	AN15-C08		
<b>VQ2101</b>	Tube bore x Length	T0806 (O.D. ø8/I.D. ø6) x 1 m		
	Speed controller	AS3002F-08		
	Silencer	AN20-C10		

# INDEX

Features .....	P. 366
Variations .....	P. 368
Cylinder Speed Chart .....	P. 370
<b>VQ1000</b> How to Order, Manifold Options .....	P. 372
<b>VQ2000</b> How to Order, Manifold Options .....	P. 376
<b>VQ1000/2000</b> Model, Standard/Manifold Specifications .....	P. 380
<b>VQ1000/2000</b> <b>F</b> kit (D-sub connector) .....	P. 382
<b>VQ1000/2000</b> <b>P</b> kit (Flat ribbon cable) .....	P. 386
<b>VQ1000/2000</b> <b>T</b> kit (Terminal block box) .....	P. 398
<b>VQ1000/2000</b> <b>L</b> kit (Lead wire) .....	P. 402
<b>VQ1000/2000</b> <b>S</b> kit (Serial transmission) EX510 .....	P. 406
<b>VQ1000/2000</b> <b>S</b> kit (Serial transmission) EX120/123/124 .....	P. 410
<b>VQ2000</b> <b>M</b> kit (Circular connector) .....	P. 414
<b>VQ2000</b> Sub-plate Single Unit .....	P. 417
<b>VQ1000/2000</b> Semi-standard .....	P. 418
<b>VQ1000/2000</b> Construction .....	P. 422
<b>VQ1000/2000</b> Exploded View of Manifold .....	P. 424
<b>VQ1000/2000</b> Manifold Optional Parts .....	P. 428
<b>VQ1000/2000</b> Specific Product Precautions .....	P. 441

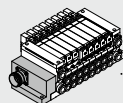
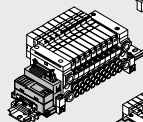
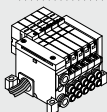
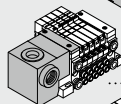
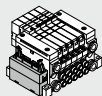
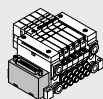

SV
SYJ
SZ
VF
VP4
VQ 1/2
VQ 4/5
VQC 1/2
VQC 4/5
VQZ
SQ
VFS
VFR
VQ7

# Plug-in Unit

## Base Mounted

# VQ1000 Series



[Option]  
Note) For CE-compliant models, DC-type only.

### How to Order Manifold

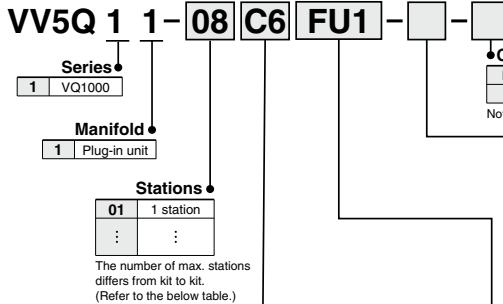

### Cylinder port

Symbol	Port size	Symbol	Port size
C3	With ø3.2 One-touch fitting	L5	Top ported elbow M5 thread
C4	With ø4 One-touch fitting	B3	Bottom ported elbow with ø3.2 One-touch fitting
C6	With ø6 One-touch fitting	B4	Bottom ported elbow with ø4 One-touch fitting
M5	M5 thread	B6	Bottom ported elbow with ø6 One-touch fitting
CM (Note 1)	Mixed sizes and with port plug	B5	Bottom ported elbow M5 thread
L3	Top ported elbow with ø3.2 One-touch fitting	LM (Note 1)	Elbow port, mixed sizes (Including upward, downward piping and mixed)
L4	Top ported elbow with ø4 One-touch fitting	MM (Note 2)	Mixed size for different types of piping, option installed
L6	Top ported elbow with ø6 One-touch fitting		

- Note 1) Indicate "Mixed sizes and with port plug" by means of the manifold specification sheet.  
 Note 2) When selecting the mixed size for different types of piping or dual flow fitting assembly, enter "MM" and give instructions in the manifold specification sheet.  
 Note 3) Inch-size One-touch fittings are also available. Refer to page 420 for details.  
 Note 4) M5 fittings for M5 thread are attached without being incorporated.

Simple specials are available with SMC Simple Specials System. Please contact your local representative for more details.

### Kit type/Electrical entry/Cable length

F kit (D-sub connector)		P kit (Flat ribbon cable)	
<p>Note 1) 25P</p>		<p>Note 1) 26P</p>	
<b>P. 382</b> Connector entry direction Top entry Side entry		<b>P. 386</b> Connector entry direction Top entry Side entry	
FU0	FS0	Without cable	Note 2)
FU1	FS1	With cable (1.5 m)	2 to 24 stations
FU2	FS2	With cable (3 m)	
FU3	FS3	With cable (5 m)	
PU0	PS0	Without cable	Note 2)
PU1	PS1	With cable (1.5 m)	2 to 24 stations
PU2	PS2	With cable (3 m)	
PU3	PS3	With cable (5 m)	

- Note 1) Besides the above, F/P kit with different number of pins are available. Refer to page 418 for details.  
 Note 2) Refer to page 419 for details.

Symbol	Option
Nil	None
2	200/220 VAC models (F/L kit only)
B (Note 2)	With back pressure check valve
D	DIN rail mounting
D0	With DIN rail bracket (Without DIN rail)
D□ (Note 7)	DIN rail length specified
G1 (Note 3)	1 set of regulator unit
G2 (Note 3)	2 sets of regulator unit
G3 (Note 3)	3 sets of regulator unit
J□ (Note 4)	With ejector unit
K (Note 5)	Special wiring spec. (Except double wiring)
N (Note 9)	With name plate
R (Note 6)	External pilot
S	Direct EXH outlet with built-in silencer

- Note 1) When multiple symbols are specified, indicate them by letter in the order that they appear in the table, starting from the top. Example: -BRS  
 Note 2) Models with a suffix "-B" have check valves for prevention of back pressure at all manifold stations. When a back pressure check valve is desired, and is to be installed only in certain manifold stations, specify the mounting position by means of the manifold specification sheet.  
 Note 3) Specify the mounting position by means of the manifold specification sheet.  
 Note 4) Refer to page 432 for details on with vacuum ejector unit. A combination of "J" and "N" is not available.  
 Note 5) Specify the wiring specifications by means of the manifold specification sheet. (Except L kit)  
 Note 6) Indicate "R" for the valve with external pilot.  
 Note 7) □: Station. Example: D08. The number of stations that may be displayed is longer than the manifold number of stations.  
 Note 8) G1, G2, or G3 cannot be combined with N.  
 Note 9) When mounting the blanking plate with connector and the slide locking manual type valve by ordering only the manifold, order the name plate separately. For details, refer to page 429.

Note) For CE-compliant models, DC-type only.



How to Order Valves

How to Order Manifold Assembly

VQ 1 1 0 0 - 5 1 -

Series  
1 VQ1000

Type of actuation

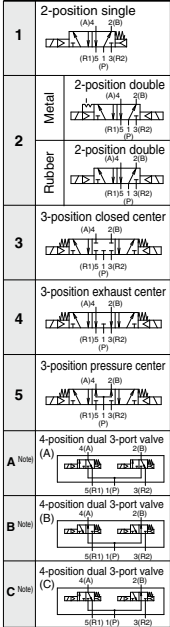

Note) Rubber seal only

Seal  
0 Metal seal  
1 Rubber seal

Function

Symbol	Specifications	DC	AC
Nil	Standard	(0.4 W) ○ Note 1)	○ Note 1)
B	High-speed response type	(0.95 W) ○	—
K	High-pressure type (1.0 MPa)	(0.95 W) ○	—
N	Negative common	○	—
R	External pilot	○	○

Note 1) Refer to page 381 for power consumption of AC type.

Note 2) Metal seal only

Note 3) For external pilot and negative common specifications, refer to "Semi-standard" on pages 419 and 420.

Note 4) When two or more symbols are specified, indicate them alphabetically. Combination of [B] and [K] is not possible.

Note 5) Dual 3-port valve is not applicable.

CE-compliant  
Nil —  
Q CE-compliant

Note) For CE-compliant models, DC-type only.

Manual override

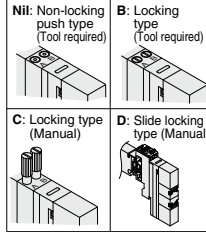

Light/surge voltage suppressor

Nil	Yes
E	None (Non-polar)

Note 1) Not applicable to the S kit.

Note 2) A combination of "Function [N] (Negative common)" and [E] is unavailable.

Since [E] has no polarity, it can also be used as a negative common. Selection of "Function [N]" is not required.

Coil voltage

		CE-compliant
1	100 VAC (50/60 Hz)	—
2	200 VAC (50/60 Hz)	—
3	110 VAC (50/60 Hz)	—
4	220 VAC (50/60 Hz)	—
5	24 VDC	●
6	12 VDC	●

Note) 200 and 220 VAC: F/L kit only

Example

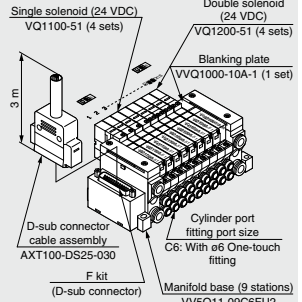

- VV5Q11-09C6FU2 ... 1 set (F kit 9-station manifold base part no.)
- VQ1100-51 ... 4 sets (Single solenoid part no.)
- VQ1200-51 ... 4 sets (Double solenoid part no.)
- VVQ1000-10A-1 ... 1 set (Blanking plate part no.)

The asterisk denotes the symbol for assembly. Prefix it to the part nos. of the solenoid valve, etc.

Specify the part numbers for valves and options together beneath the manifold base part number. Besides, when the arrangement will be complicated, specify them by means of the manifold specification sheet.

Caution

Use the standard (DC) specification when continuously energizing for long periods of time.

T kit (Terminal block box)

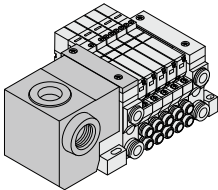

P. 398

L kit (Lead wire)

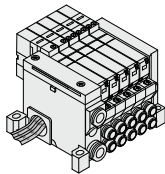

P. 402

S kit (Serial transmission)

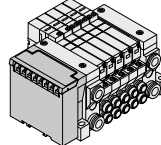

The valve is equipped with an indicator light and surge voltage suppressor, and the voltage is 24 VDC.

Note) Refer to "SI Unit Part No." on page 410 when ordering the CE-compliant SI unit

P. 410

T0	Terminal block box	2 to 24 stations <sup>Note 2)</sup>	L0	With cable (0.6 m)	1 to 8 stations	L1	With cable (1.5 m)	L2	With cable (3 m)							
S0	Without SI unit	Note 2)	SH	NKE Corp.: Fieldbus H System	Max. 16 stations	SQ	DeviceNet™	SR1	OMRON Corp.: CompoBus/S (16 outputs)	Max. 16 stations	SR2	OMRON Corp.: CompoBus/S (8 outputs)	Max. 8 stations	V	CC-LINK	Max. 16 stations
ZB	CompoNet™(Positive common)		ZBN	CompoNet™(Negative common)												

Blanking plate assembly  
VVQ1000-10A-1

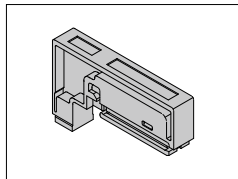

Individual SUP spacer  
VVQ1000-P-1-C<sub>3</sub>-N<sub>7</sub>

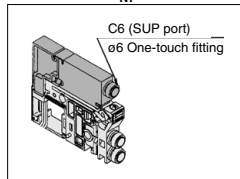

Individual EXH spacer  
VVQ1000-R-1-C<sub>6</sub>-N<sub>7</sub>

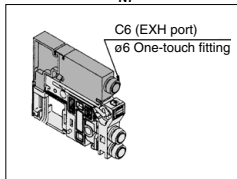

SUP block plate  
VVQ1000-16A

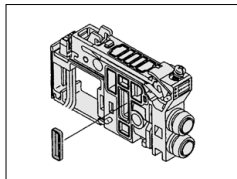

Blanking plate with connector  
VVQ1000-1C□-□

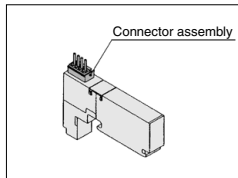

EXH block base assembly  
VVQ1000-19A-

F□	C3, C4
P□	C6, N5
L□	N1, N3
N□	N7

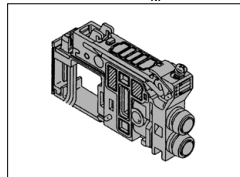

Back pressure check valve assembly [-B]  
VVQ1000-18A

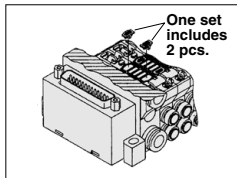

Name plate [-N]  
VVQ1000-N-Station  
(1 to Max. stations) (-X4)

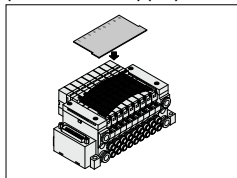

Blanking plug  
KQ2P-□

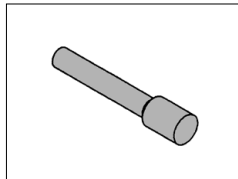

Port plug  
VVQ0000-58A

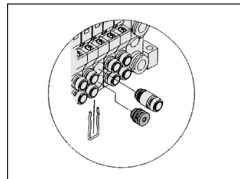

Elbow fitting assembly  
VVQ1000-F-L□

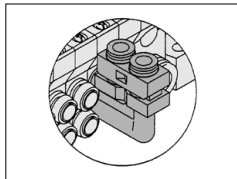

DIN rail mounting bracket  
[-D/-D0/-D□]  
VVQ1000-57A

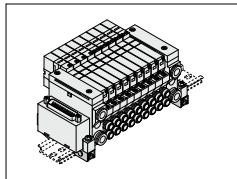

Direct EXH outlet with built-in silencer [-S]

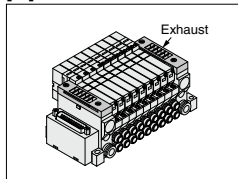

Dual flow fitting assembly  
VVQ1000-52A-C<sub>3</sub>-N<sub>3</sub>

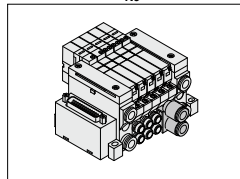

Silencer (For EXH port)  
AN15-C08

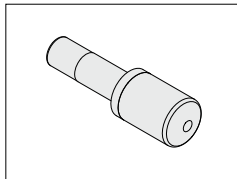

- Refer to page 442 for cylinder port fittings part number.
- Refer to page 425 for replacement parts.

Regulator unit  
VVQ1000-AR-1

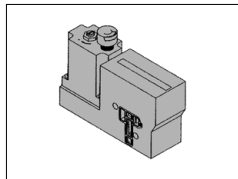

Double check block  
VQ1000-FPG-□□-□

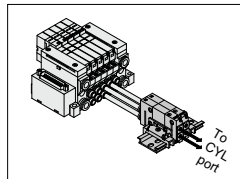

With ejector unit [-J□]

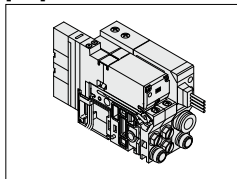

<b>SV</b>
<b>SYJ</b>
<b>SZ</b>
<b>VF</b>
<b>VP4</b>
<b>VQ</b> 1/2
<b>VQ</b> 4/5
<b>VQC</b> 1/2
<b>VQC</b> 4/5
<b>VQZ</b>
<b>SQ</b>
<b>VFS</b>
<b>VFR</b>
<b>VQ7</b>

# Plug-in Unit

## Base Mounted

# VQ2000 Series



[Option]  
Note) For CE-compliant models, DC-type only.

### How to Order Manifold

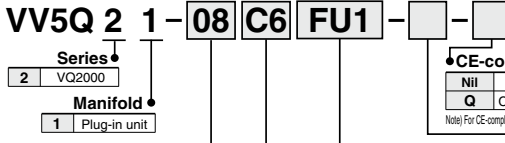

#### Option

Symbol	Option
<b>Nil</b>	None
<b>2</b>	200/220 VAC models (F/L kit only)
<b>B</b> (Note 2)	With back pressure check valve
<b>D</b>	DIN rail mounting
<b>DO</b>	With DIN rail bracket (Without DIN rail)
<b>D</b> (Note 5)	DIN rail length specified
<b>K</b> (Note 3)	Special wiring spec. (Except double wiring)
<b>N</b> (Note 4)	With name plate
<b>R</b> (Note 4)	External pilot
<b>S</b>	Direct EXH outlet with built-in silencer
<b>W</b> (Note 7)	Enclosure: Dust-tight, Water-jet-proof (IP65) (T/L/S/M kit only)

#### Stations

01	1 station
:	:

The maximum and minimum number of stations are varied depending on kit.  
(Refer to the below table.)

#### Cylinder port

Symbol	Port size	Symbol	Port size
<b>C4</b>	With ø4 One-touch fitting	<b>L8</b>	Top ported elbow with ø8 One-touch fitting
<b>C6</b>	With ø6 One-touch fitting	<b>B4</b>	Bottom ported elbow with ø4 One-touch fitting
<b>C8</b>	With ø8 One-touch fitting	<b>B6</b>	Bottom ported elbow with ø6 One-touch fitting
<b>CM</b> (Note 1)	Mixed sizes and with port plug	<b>B8</b>	Bottom ported elbow with ø8 One-touch fitting
<b>L4</b>	Top ported elbow with ø4 One-touch fitting	<b>LM</b> (Note 1)	Elbow port, mixed sizes (including upward, downward piping and mixed)
<b>L6</b>	Top ported elbow with ø6 One-touch fitting	<b>MM</b> (Note 2)	Mixed size for different types of piping, option installed

- Note 1) Indicate "Mixed size and with port plug" by means of the manifold specification sheet.
- Note 2) When selecting the mixed size for different types of piping, dual flow fitting assembly, or double check block (direct mounting), enter "MM" and give instructions in the manifold specification sheet.
- Note 3) Inch-size One-touch fittings are also available. Refer to page 420 for details.

Simple specials are available with SMC Simple Specials System.  
Please contact your local representative for more details.

#### Kit type/Electrical entry/Cable length

#### F kit (D-sub connector)

Connector entry direction	Side entry	P. 382
Top entry	Side entry	
<b>FU0</b>	<b>FS0</b>	Without cable
<b>FU1</b>	<b>FS1</b>	With cable (1.5 m)
<b>FU2</b>	<b>FS2</b>	With cable (3 m)
<b>FU3</b>	<b>FS3</b>	With cable (5 m)

Note 2) 2 to 24 stations

#### P kit (Flat ribbon cable)

Connector entry direction	Side entry	P. 386
Top entry	Side entry	
<b>PU0</b>	<b>PS0</b>	Without cable
<b>PU1</b>	<b>PS1</b>	With cable (1.5 m)
<b>PU2</b>	<b>PS2</b>	With cable (3 m)
<b>PU3</b>	<b>PS3</b>	With cable (5 m)

Note 2) 2 to 24 stations

#### T kit (Terminal block box)

Dust-tight/Water-jet-proof (IP65) compatible (Note 3)

P. 398

Note 2) Terminal block box | 2 to 20 stations (Note 2)

#### L kit (Lead wire)

Dust-tight/Water-jet-proof (IP65) compatible (Note 3)

P. 402

<b>L0</b>	With cable (0.6 m)	1 to 3 stations
<b>L1</b>	With cable (1.5 m)	
<b>L2</b>	With cable (3 m)	

#### S kit (Serial transmission)

The valve is equipped with an indicator light and surge voltage suppressor, and the voltage is 24 VDC. Dust-tight, Water-jet-proof (IP65) is available. (Note 3)

Note) Refer to "SI Unit Part No." on page 410 when ordering the CE-compliant SI unit

P. 410

<b>S0</b>	Without SI unit	Note 2) Max. 16 stations
<b>SH</b>	NKE Corp.: Fieldbus H System	
<b>SQ</b>	DeviceNet™	Max. 16 stations
<b>SR1</b>	OMRON Corp.: CompoBus/S (16 outputs)	
<b>SR2</b>	OMRON Corp.: CompoBus/S (8 outputs)	Max. 8 stations
<b>SV</b>	CC-LINK	
<b>SZB</b>	CompoNet™(Positive common)	Max. 16 stations
<b>SZBN</b>	CompoNet™(Negative common)	

#### M kit (Circular-connector)

Dust-tight/Water-jet-proof (IP65) compatible (Note 3)

P. 414

<b>M0</b>	Without cable	Note 2) 2 to 24 stations
<b>M1</b>	With cable (1.5 m)	
<b>M2</b>	With cable (3 m)	
<b>M3</b>	With cable (5 m)	

Note 1) Besides the above, F/P kit with different number of pins are available. Refer to page 418 for details.

Note 2) Refer to page 419 for details.  
Note 3) Refer to the pages on respective kits for IP65 type. (T/L/S/M kit)





Note) For CE-compliant models, DC-type only.



How to Order Valves

How to Order Manifold Assembly

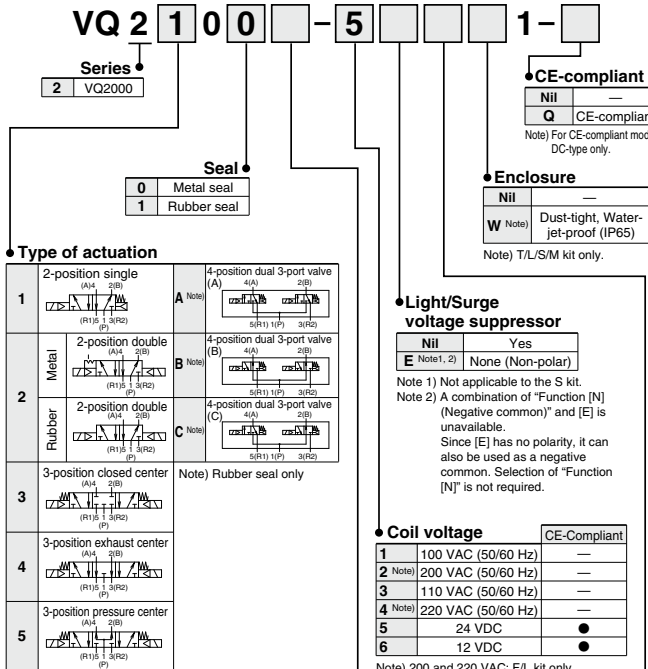

Example

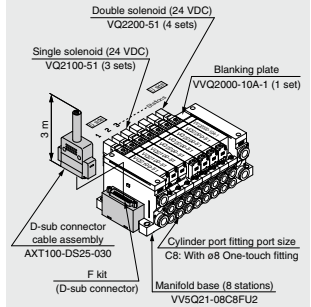

VV5Q21-08C8FU2 1 set (F kit 8-station manifold base part no.)  
 \*VQ2100-51 ..... 3 sets (Single solenoid part no.)  
 \*VQ2200-51 ..... 4 sets (Double solenoid part no.)  
 \*VVQ2000-10A-1 ..... 1 set (Blanking plate part no.)  
 The asterisk denotes the symbol for assembly. Prefix it to the part nos. of the solenoid valve, etc.

Specify the part numbers for valves and options together beneath the manifold base part number. Besides, when the arrangement will be complicated, specify them by means of the manifold specification sheet.

Manual override

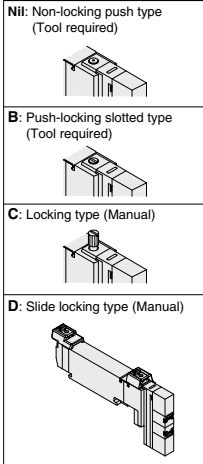

⚠ Caution

Use the standard (DC) specification when continuously energizing for long periods of time.

- SV
- SYJ
- SZ
- VF
- VP4
- VQ 1/2
- VQ 4/5
- VQC 1/2
- VQC 4/5
- VQZ
- SQ
- VFS
- VFR
- VQ7

# VQ2000 Series

## VQ2000: Manifold Options

P. 434 to 438

Blanking plate assembly  
VVQ2000-10A-1

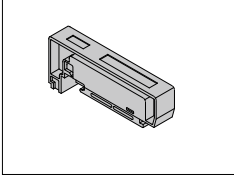

Individual SUP spacer  
VVQ2000-P-1-C<sub>8</sub>-N<sub>8</sub>

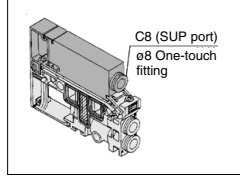

Individual EXH spacer  
VVQ2000-R-1-C<sub>8</sub>-N<sub>8</sub>

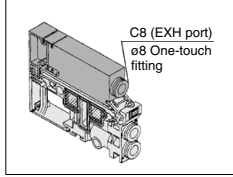

SUP block plate  
VVQ2000-16A

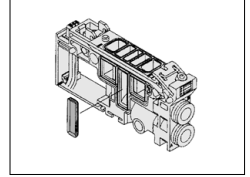

EXH block plate  
VVQ2000-19A

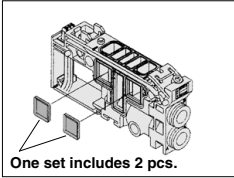

SUP stop valve spacer  
VVQ2000-24A-1

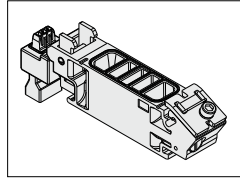

Back pressure check valve  
assembly [-B]  
VVQ2000-18A

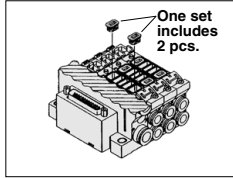

Name plate [-N]  
VVQ2000-N-Station  
(1 to Max. stations) (-X4)

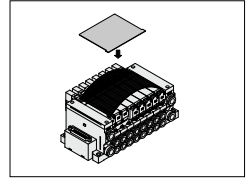

Blanking plug  
KQ2P-□

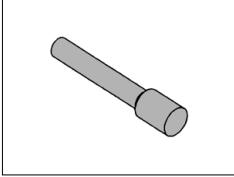

Port plug  
VVQ1000-58A

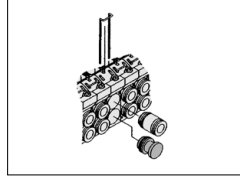

DIN rail mounting bracket  
[-D/-D0/-D□]  
VVQ2000-57A

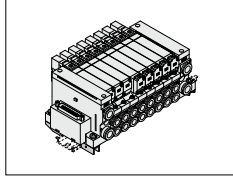

Direct EXH outlet with  
built-in silencer  
[-S]

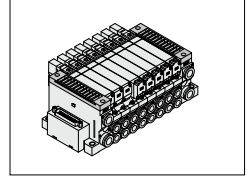

Silencer (For EXH port)  
AN20-C10

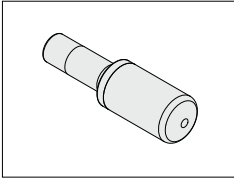

Elbow fitting assembly  
VVQ2000-F-L□

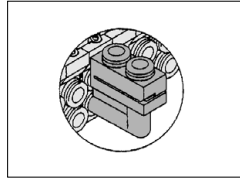

Dual flow fitting assembly  
VVQ2000-52A-C<sub>10</sub>-N<sub>11</sub>

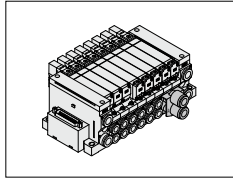

- Refer to page 442 for cylinder port fittings part number.
- Refer to page 427 for replacement parts.

Double check block  
(Separated)  
VQ2000-FPG-□□-□

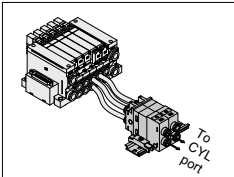

Double check block  
(Direct mounting)  
VVQ2000-23A-□

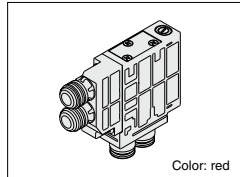

<b>SV</b>
<b>SYJ</b>
<b>SZ</b>
<b>VF</b>
<b>VP4</b>
<b>VQ</b> 1/2
<b>VQ</b> 4/5
<b>VQC</b> 1/2
<b>VQC</b> 4/5
<b>VQZ</b>
<b>SQ</b>
<b>VFS</b>
<b>VFR</b>
<b>VQ7</b>

# Plug-in Unit

## Base Mounted

# VQ1000/2000 Series

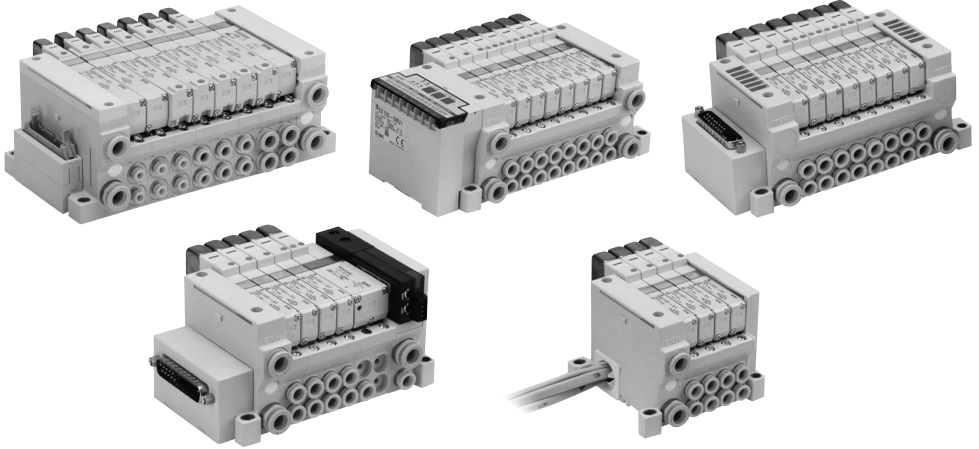

### Model

Series	Type of actuation	Model		Flow rate characteristics <sup>Note 1)</sup>						Response time (ms) <sup>Note 2)</sup>			Weight (g)	
				1 → 2/4 (P → A/B)			2/4 → 3/5 (A/B → R1/R2)			Standard: 0.4 W	High-speed response: 0.95 W	AC		
				C [dm <sup>3</sup> /(s·bar)]	b	Cv	C [dm <sup>3</sup> /(s·bar)]	b	Cv					
VQ1000	2-position	Single	Metal seal	VQ1100	0.70	0.15	0.16	0.72	0.25	0.18	15 or less	12 or less	29 or less	67
			Rubber seal	VQ1101	0.85	0.20	0.21	1.0	0.30	0.25	20 or less	15 or less	34 or less	
		Double	Metal seal	VQ1200	0.70	0.15	0.16	0.72	0.25	0.18	13 or less	10 or less	13 or less	
			Rubber seal	VQ1201	0.85	0.20	0.21	1.0	0.30	0.25	20 or less	15 or less	20 or less	
	3-position	Closed center	Metal seal	VQ1300	0.68	0.15	0.16	0.72	0.25	0.18	26 or less	20 or less	40 or less	77
			Rubber seal	VQ1301	0.70	0.20	0.16	0.65	0.42	0.18	33 or less	25 or less	47 or less	
		Exhaust center	Metal seal	VQ1400	0.68	0.15	0.16	0.72	0.25	0.18	26 or less	20 or less	40 or less	
			Rubber seal	VQ1401	0.70	0.20	0.16	1.0	0.30	0.25	33 or less	25 or less	47 or less	
		Pressure center	Metal seal	VQ1500	0.70	0.15	0.16	0.72	0.25	0.18	26 or less	20 or less	40 or less	
			Rubber seal	VQ1501	0.85	0.20	0.21	0.65	0.42	0.18	33 or less	25 or less	47 or less	
4-position	Dual 3-port valve	Rubber seal	VQ <sub>C</sub> <sup>A</sup> 01	0.70	0.20	0.16	0.70	0.20	0.16	33 or less	25 or less	47 or less		
VQ2000	2-position	Single	Metal seal	VQ2100	2.0	0.15	0.46	2.6	0.15	0.60	29 or less	22 or less	49 or less	95
			Rubber seal	VQ2101	2.2	0.28	0.55	3.2	0.30	0.80	31 or less	24 or less	51 or less	
		Double	Metal seal	VQ2200	2.0	0.15	0.46	2.6	0.15	0.60	20 or less	15 or less	20 or less	
			Rubber seal	VQ2201	2.2	0.28	0.55	3.2	0.30	0.80	26 or less	20 or less	26 or less	
	3-position	Closed center	Metal seal	VQ2300	2.0	0.15	0.46	2.0	0.18	0.46	38 or less	29 or less	58 or less	105
			Rubber seal	VQ2301	2.0	0.28	0.49	2.2	0.31	0.60	44 or less	34 or less	64 or less	
		Exhaust center	Metal seal	VQ2400	2.0	0.15	0.46	2.6	0.15	0.60	38 or less	29 or less	58 or less	
			Rubber seal	VQ2401	2.0	0.28	0.49	3.2	0.30	0.80	44 or less	34 or less	64 or less	
		Pressure center	Metal seal	VQ2500	2.4	0.17	0.57	2.0	0.18	0.46	38 or less	29 or less	58 or less	
			Rubber seal	VQ2501	3.2	0.28	0.80	2.2	0.31	0.60	44 or less	34 or less	64 or less	
	4-position	Dual 3-port valve	Rubber seal	VQ <sub>C</sub> <sup>A</sup> 01	1.8	0.28	0.46	1.8	0.28	0.46	44 or less	34 or less	64 or less	

Note 1) The values are given for port size C6; (VQ1000), C8; (VQ2000) without back pressure check valve.

Note 2) As per JIS B 8419: 2010 (Supply pressure 0.5 MPa; with indicator light/surge voltage suppressor; clean air

The response time is subject to the pressure and quality of the air.) The values at the time of ON are given for double types.

**Symbol**

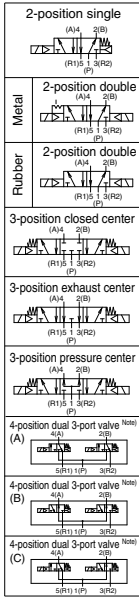

Note) Rubber seal only

**Standard Specifications**

Valve specifications	Valve type	Metal seal	Rubber seal	
	Fluid	Air	Air	
	Maximum operating pressure	0.7 MPa (High-pressure type: 1.0 MPa)		
	Minimum operating pressure	Single	0.1 MPa	0.15 MPa
		Double	0.1 MPa	0.1 MPa
		3-position	0.1 MPa	0.2 MPa
		4-position	—	0.15 MPa
	Ambient and fluid temperature	-10 to 50°C (Note 1)		
	Lubrication	Not required		
	Manual override	Push type, Locking type (Tool required, Manual) semi-standard		
Impact/Vibration resistance (Note 2)	150/30 m/s <sup>2</sup>			
Enclosure	Dust-protected; Dust-tight, Water-jet-proof (IP65) (Note 4)			
Electrical specifications	Coil rated voltage	12, 24 VDC, 100, 110, 200, 220 VAC (50/60 Hz)		
	Allowable voltage fluctuation	±10% of rated voltage		
	Coil insulation type	Equivalent to Class B		
	Power consumption (Current)	24 VDC	0.4 W DC (17 mA), 0.95 W DC (40 mA) (Note 3)	
		12 VDC	0.4 W DC (34 mA), 0.95 W DC (80 mA) (Note 3)	
		100 VAC	Inrush 0.96 VA (10 mA), Holding 0.96 VA (10 mA)	
		110 VAC	Inrush 1.0 VA (9 mA), Holding 1.0 VA (9 mA)	
		200 VAC	Inrush 1.26 VA (6 mA), Holding 1.26 VA (6 mA)	
		220 VAC	Inrush 1.38 VA (6 mA), Holding 1.38 VA (6 mA)	

Note 1) Use dry air to prevent condensation when operating at low temperatures.

Note 2) Impact resistance ..... No malfunction occurred when it is tested in the axial direction and at the right angles to the main valve and armature in both energized and de-energized states every once for each condition. (Values at the initial period)

Vibration resistance ... No malfunction occurred in a one-sweep test between 45 and 2000 Hz. Test was performed at both energized and de-energized states in the axial direction and at the right angles to the main valve and armature. (Values at the initial period)

Note 3) Value for high-speed response, high-voltage type (0.95 W)

Note 4) Dust-tight, water-jet-proof (IP65) is available on T/L/S/M kit of the VQ2000.

**Manifold Specifications**

Series	Base model	Connection type	Piping direction	Piping specifications		Applicable stations	Applicable solenoid valve	5-station weight (g)
				Port size (Note 1)				
				1(P), 3(R)	4(A), 2(B)			
VQ1000	VVSQ11-□□□	F kit-D-sub connector P kit-Flat ribbon cable T kit-Terminal block box L kit-Lead wire S kit-Serial transmission	Side	C8 (ø8)	C3 (ø3.2)	F/P/T kit (2 to 24 stations) S kit (2 to 16 stations) L kit (1 to 8 stations)	VQ1□00 VQ1□01	643 (Single) 754 (Double, 3-position)
				Option: Direct EXH outlet with built-in silencer	C4 (ø4) C6 (ø6) M5 (M5 thread)			
VQ2000	VVSQ21-□□□	F kit-D-sub connector P kit-Flat ribbon cable T kit-Terminal block box L kit-Lead wire S kit-Serial transmission M kit-Circular connector	Side	C10 (ø10)	C4 (ø4)	F/P kit (2 to 24 stations) S kit (2 to 16 stations) L kit (1 to 8 stations) T kit (2 to 20 stations)	VQ2□00 VQ2□01	1076 (Single) 1119 (Double, 3-position)
				Option: Direct EXH outlet with built-in silencer	C6 (ø6) C8 (ø8)			

Note 1) Inch-size One-touch fittings are also available. Refer to page 420 for details.

Note 2) Refer to page 419 for details.

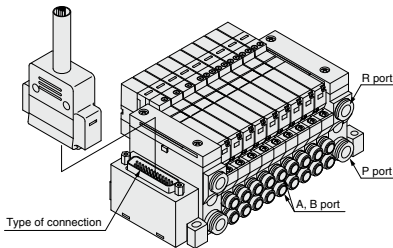

VVSQ11

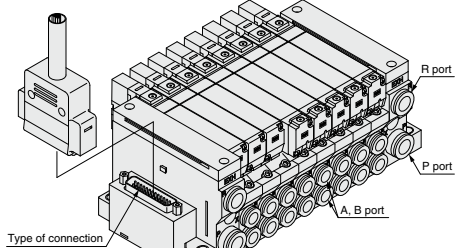

VVSQ21

# F VQ1000/2000 Series Kit (D-sub connector)

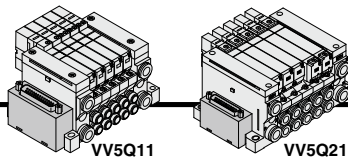

- D-sub connector reduces installation labor for electrical connections.
- Using the D-sub connector (25P), (15P as semi-standard) conforming to MIL standard permits the use of connectors put on the market and gives a wide interchangeability.
- Top or side receptacle position can be selected in accordance with the available mounting space.
- Maximum stations are 24.

## Manifold Specifications

Series	Piping specifications			Applicable stations
	Piping direction	Port size		
VQ1000	Side	C8	C3, C4, C6, M5	Max. 24 stations
VQ2000	Side	C10	C4, C6, C8	Max. 24 stations

## D-sub Connector (25 Pins)

015  
AXT100-DS25-030  
050

(The D-sub connector cable assembly can be ordered individually or included in a specific manifold model no. Refer to "How to Order Manifold.")

**D-sub connector cable assembly**

Cable length (L)	Assembly part no.	Note
1.5 m	AXT100-DS25-015	Cable 25 cores x 24AWG
3 m	AXT100-DS25-030	
5 m	AXT100-DS25-050	

- For other commercial connectors, use a 25 pins type with female connector conforming to MIL-C-24308.
- Cannot be used for transfer wiring.

**Connector manufacturers' example**

- Fujitsu Limited
- Japan Aviation Electronics Industry, Limited
- J.S.T. Mfg. Co., Ltd.
- HIROSE ELECTRIC CO., LTD.

Note 1) Types with 15 pins are also available. Refer to page 418 for details.  
Note 2) Lengths other than the above are also available. Please contact SMC for details.

## Cable Assembly

### Wire color by terminal no. of D-sub connector cable assembly

Terminal no.	Lead wire color	Dot marking
1	Black	None
2	Brown	None
3	Red	None
4	Orange	None
5	Yellow	None
6	Pink	None
7	Blue	None
8	Purple	White
9	Gray	Black
10	White	Black
11	White	Red
12	Yellow	Red
13	Orange	Red
14	Yellow	Black
15	Pink	Black
16	Blue	White
17	Purple	None
18	Gray	None
19	Orange	Black
20	Red	White
21	Brown	White
22	Pink	Red
23	Gray	Red
24	Black	White
25	White	None

### Electrical characteristics

Item	Property
Conductor resistance $\Omega/\text{km}$ , 20°C	65 or less
Voltage limit V, 1 min, AC	1000
Insulation resistance $M\Omega/\text{km}$ , 20°C	5 or more

Note) The min. bending radius of the D-sub connector cable assembly is 20 mm.

## How to Order Manifold

Series: VV5Q 1 1-08 C6 F U 1 - -

Manifold: 1 Plug-in unit

Connector entry direction: U Top entry, S Side entry

Cylinder port: C3, C4, C6, C8, M5, MM

Cable (Length): 0 Without cable, 1 With cable (1.5 m), 2 With cable (3 m), 3 With cable (5 m)

CE-compliant: Nil, Q

Symbol	Port size	VQ1000	VQ2000
C3	With $\phi 3.2$ One-touch fitting	●	—
C4	With $\phi 4$ One-touch fitting	●	●
C6	With $\phi 6$ One-touch fitting	●	●
C8	With $\phi 8$ One-touch fitting	—	●
M5	M5 thread	●	—
MM	Mixed sizes and with port plug	●	●
MM	Mixed size for different types of piping, option installed	●	●

Note 1) Insert "L" (Top ported) or "B" (Bottom ported) for elbow type.  
Example) B6 (Bottom ported elbow with  $\phi 6$  One-touch fitting)  
Note 2) Indicate "LM" (Including upward, downward piping and mixed) for models with elbow fittings and mixed cylinder port sizes.  
Note 3) Indicate "Mixed sizes and with port plug" by means of the manifold specification sheet.  
Note 4) When selecting the mixed size for different types of piping, dual flow fitting assembly, or double check block (direct mounting), enter "MM" and give instructions in the manifold specification sheet.  
Note 5) Inch-size One-touch fittings are available. Refer to "Semi-standard" on page 420 for details.

Note) For CE-compliant models, DC-type only.



## Option

Symbol	Option	VQ1000	VQ2000
Nil	None	●	●
2	200/220 VAC models (F/L kit only)	●	●
B	2) With back pressure check valve	●	●
D	D) DIN rail mounting	●	●
DO	With DIN rail bracket (Without DIN rail)	●	●
D□	3) DIN rail length specified (□: Stations 02 to 24)	●	●
G1	1 set of regulator unit	●	—
G2	2 sets of regulator unit	●	—
G3	3 sets of regulator unit	●	—
J□	With ejector unit	●	—
K	6) Special wiring specifications (Except double wiring)	●	●
N	With name plate	●	●
R	7) External pilot	●	●
S	Direct EXH outlet with built-in silencer	●	●

- Note 1) When two or more symbols are specified, indicate them alphabetically. Example) -BRS
- Note 2) Models with a suffix "B" have check valves for prevention of back pressure at all manifold stations. When a back pressure check valve is desired, and is to be installed only in certain manifold stations, specify the mounting position by means of the manifold specification sheet.
- Note 3) The number of stations that may be displayed is longer than the manifold number of stations.
- Note 4) Specify the mounting position by means of the manifold specification sheet.
- Note 5) Refer to page 432 for the details on with ejector unit. A combination of "J" and "N" is not available.
- Note 6) Specify the wiring specifications by means of the manifold specification sheet.
- Note 7) Indicate "R" for the valve with external pilot.
- Note 8) G1, G2, or G3 cannot be combined with N.

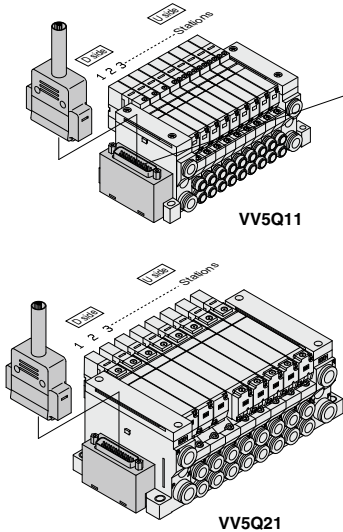

Electrical Wiring Specifications

**D-sub connector assembly**  
015  
AXT100-DS25-030 Wire color  
050

Terminal no.	Polarity	Lead wire color	Dot marking
SOL A 1	(-)	Black	None
SOL B 1	(+)	Yellow	Black
SOL A 2	(-)	Black	None
SOL B 2	(+)	Brown	None
SOL A 3	(-)	Black	None
SOL B 3	(+)	Pink	Black
SOL A 4	(-)	Black	None
SOL B 4	(+)	Red	None
SOL A 5	(-)	Black	None
SOL B 5	(+)	Blue	White
SOL A 6	(-)	Black	None
SOL B 6	(+)	Orange	None
SOL A 7	(-)	Black	None
SOL B 7	(+)	Purple	None
SOL A 8	(-)	Black	None
SOL B 8	(+)	Yellow	None
SOL A 9	(-)	Black	None
SOL B 9	(+)	Gray	None
SOL A 10	(-)	Black	None
SOL B 10	(+)	Pink	None
SOL A 11	(-)	Black	None
SOL B 11	(+)	Gray	Black
SOL A 12	(-)	Black	None
SOL B 12	(+)	Blue	None
SOL A 13	(-)	Black	None
SOL B 13	(+)	Red	White
SOL A 14	(-)	Black	None
SOL B 14	(+)	Purple	White
SOL A 15	(-)	Black	None
SOL B 15	(+)	Brown	White
SOL A 16	(-)	Black	None
SOL B 16	(+)	Orange	White
SOL A 17	(-)	Black	None
SOL B 17	(+)	Gray	White
SOL A 18	(-)	Black	None
SOL B 18	(+)	Pink	White
SOL A 19	(-)	Black	None
SOL B 19	(+)	Gray	Black
SOL A 20	(-)	Black	None
SOL B 20	(+)	Blue	None
SOL A 21	(-)	Black	None
SOL B 21	(+)	Red	White
SOL A 22	(-)	Black	None
SOL B 22	(+)	Purple	White
SOL A 23	(-)	Black	None
SOL B 23	(+)	White	Black
SOL A 24	(-)	Black	None
SOL B 24	(+)	White	Red
SOL A 25	(-)	Black	None
SOL B 25	(+)	Black	Red
COM.	(+)	Orange	Red
COM.	(-)	Orange	Red

As the standard electrical wiring specifications, double wiring (connected to SOL A and SOL B) is adopted for the internal wiring of each station for 12 stations or less, regardless of valve and option types. Mixed single and double wiring is available as semi-standard. Refer to page 419 for details.

Note) When using the negative common specifications, use valves for negative common. (Refer to page 419.) Refer to "Semi-standard" on page 419 for details.

The total number of stations is tabulated starting from station one on the D-side.

How to Order Valves

Note) For CE-compliant models, DC-type only.



VQ 1 1 0 0 - 5 1 -

**Series**

1	VQ1000
2	VQ2000

**Type of actuation**

1	2-position single
2	2-position double
3	3-position closed center
4	3-position exhaust center
5	3-position pressure center
A	4-position dual port (N.C. +N.C.)
B	4-position dual port (N.O. +N.O.)
C	4-position dual port (N.C. +N.O.)

**Seal**

0	Metal seal
1	Rubber seal

**Function**

Symbol	Specifications	DC	AC
Nil	Standard	(0.4 W) ○ (Note 1)	○ (Note 1)
B	High-speed response type	(0.95 W) ○	—
K (Note 2)	High-pressure type (1.0 MPa)	(0.95 W) ○	—
N (Note 3)	Negative common	○	—
R (Note 3)	External pilot	○	○

Note 1) Refer to page 381 for power consumption of AC type.  
 Note 2) Metal seal only  
 Note 3) For external pilot and negative common specifications, refer to "Semi-standard" on pages 419 and 420.  
 Note 4) When two or more symbols are specified, indicate them alphabetically. Combination of [B] and [K] is not possible.  
 Note 5) Dual 3-port valve is not applicable.

**CE-compliant**

Nil	—
Q	CE-compliant

Note) For CE-compliant models, DC-type only.

**Manual override**

Nil	Non-locking push type (Tool required)
B	Locking type (Tool required)
C	Locking type (Manual)
D	Slide locking type (Manual)

**Light/surge voltage suppressor**

Nil	Yes
E (Note)	None (Non-polar)

Note) A combination of "Function [N] (Negative common)" and [E] is unavailable.  
 Since [E] has no polarity, it can also be used as a negative common. Selection of "Function [N]" is not required.

**Coil voltage**

	CE-compliant
1	100 VAC (50/60 Hz) —
2	200 VAC (50/60 Hz) —
3	110 VAC (50/60 Hz) —
4	220 VAC (50/60 Hz) —
5	24 VDC ●
6	12 VDC ●

**Caution**  
 Use the standard (DC) specification when continuously energizing for long periods of time.

How to Order Manifold Assembly

Specify the part numbers for valves and options together beneath the manifold base part number.

**<Example>**  
 D-sub connector kit with cable (3 m)  
 VV5Q11-09C6FU2-...1 set-Manifold base part no.  
 \*VQ1100-51 ..... 2 sets-Valve part no. (Stations 1 to 2)  
 \*VQ1200-51 ..... 4 sets-Valve part no. (Stations 3 to 6)  
 \*VQ1300-51 ..... 2 sets-Valve part no. (Stations 7 to 8)  
 \*VVQ1000-10A-1 ..... 1 set-Blanking plate part no. (Station 9)

Prefix the asterisk to the part nos. of the solenoid valve, etc.  
 Write sequentially from the 1st station on the D-side. When part nos. written collectively are complicated, specify them by means of the manifold specification sheet.

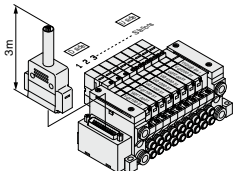

SV  
 SYJ  
 SZ  
 VF  
 VP4  
 VQ 1/2  
 VQ 4/5  
 VQC 1/2  
 VQC 4/5  
 VQZ  
 SQ  
 VFS  
 VFR  
 VQ7

# F VQ1000/2000 Series

## Kit (D-sub connector)

### VV5Q11

< >: AC  
The dashed lines indicate the DIN rail mounting [-D] and the side entry connection [-FS].

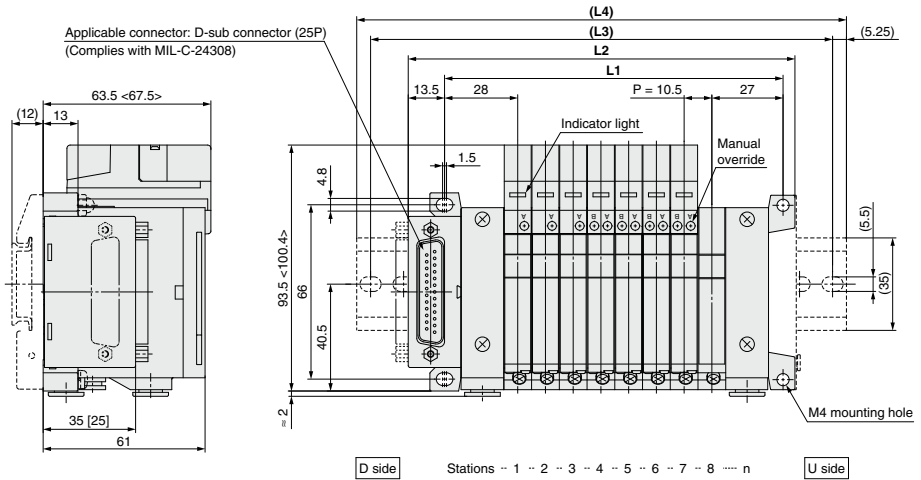

[ ]: 25 pins (top entry)

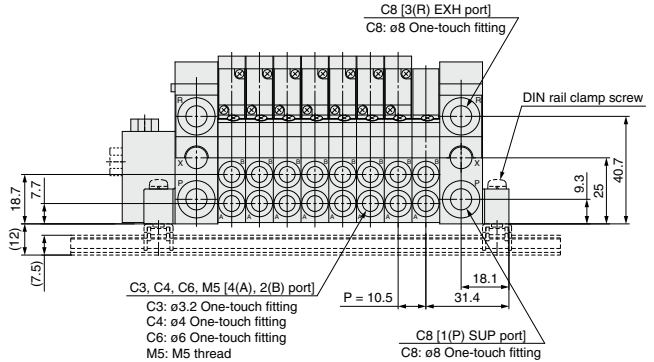

### Dimensions

Formula L1 = 10.5n + 44.5, L2 = 10.5n + 62.5 n: Station (Maximum 24 stations)

n	2	3	4	5	6	7	8	9	10	11	12	13	14	15	16	17	18	19	20	21	22	23	24
<b>L1</b>	65.5	76	86.5	97	107.5	118	128.5	139	149.5	160	170.5	181	191.5	202	212.5	223	233.5	244	254.5	265	275.5	286	296.5
<b>L2</b>	83.5	94	104.5	115	125.5	136	146.5	157	167.5	178	188.5	199	209.5	220	230.5	241	251.5	262	272.5	283	293.5	304	314.5
<b>(L3)</b>	112.5	125	125	137.5	150	162.5	175	187.5	187.5	200	212.5	225	237.5	250	250	262.5	275	287.5	300	312.5	325	325	337.5
<b>(L4)</b>	123	135.5	135.5	148	160.5	173	185.5	198	198	210.5	223	235.5	248	260.5	260.5	273	285.5	298	310.5	323	335.5	335.5	348

With ejector unit: Formula L1 = 10.5n + 28.7 + (Number of ejector units x 26.7)  
L2 = 10.5n + 46.3 + (Number of ejector units x 26.7)  
L4 is L2 plus about 30.



# VV5Q21

<->: AC

The dashed lines indicate the DIN rail mounting [-D] and the side entry connection [-FS].

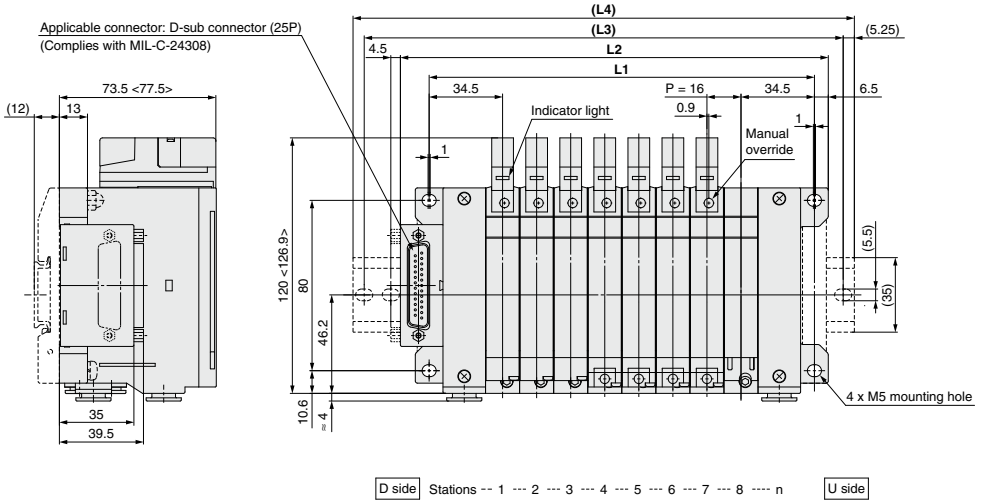

- SV
- SYJ
- SZ
- VF
- VP4
- VQ 1/2
- VQ 4/5
- VQC 1/2
- VQC 4/5
- VQZ
- SQ
- VFS
- VFR
- VQ7

D side Stations -- 1 --- 2 --- 3 --- 4 --- 5 --- 6 --- 7 --- 8 --- n U side

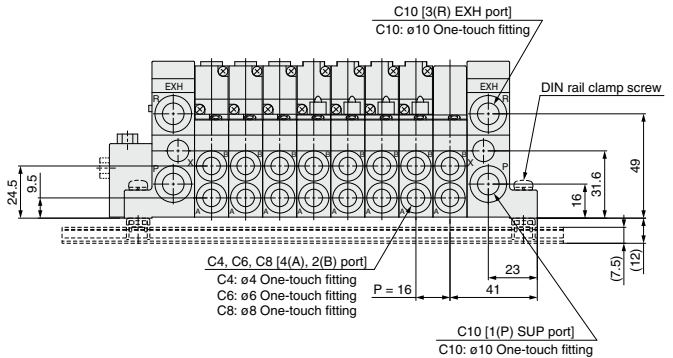

## Dimensions

Formula  $L1 = 16n + 53$ ,  $L2 = 16n + 73$  n: Station (Maximum 24 stations)

L	n	2	3	4	5	6	7	8	9	10	11	12	13	14	15	16	17	18	19	20	21	22	23	24
<b>L1</b>	85	101	117	133	149	165	181	197	213	229	245	261	277	293	309	325	341	357	373	389	405	421	437	
<b>L2</b>	105	121	137	153	169	185	201	217	233	249	265	281	297	313	329	345	361	377	393	409	425	441	457	
<b>(L3)</b>	137.5	150	162.5	187.5	200	212.5	225	250	262.5	275	300	312.5	325	337.5	350	375	387.5	400	412.5	437.5	450	462.5	487.5	
<b>(L4)</b>	148	160.5	173	198	210.5	223	235.5	260.5	273	285.5	310.5	323	335.5	348	360.5	385.5	398	410.5	423	448	460.5	473	498	

# P VQ1000/2000 Series Kit (Flat ribbon cable)

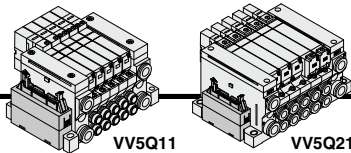

- MIL flat ribbon cable connector reduces installation labor for electrical connection.
- Using the connector for flat ribbon cable (26P) conforming to MIL standard permits the use of connectors put on the market and gives a wide interchangeability.
- Top or side receptacle position can be selected in accordance with the available mounting space.
- Maximum stations are 24.

## Manifold Specifications

Series	Piping specifications			Applicable stations
	Piping direction	Port size		
VQ1000	Side	C8	C3, C4, C6, M5	Max. 24 stations
VQ2000	Side	C10	C4, C6, C8	Max. 24 stations

## Flat Ribbon Cable (26 Pins)

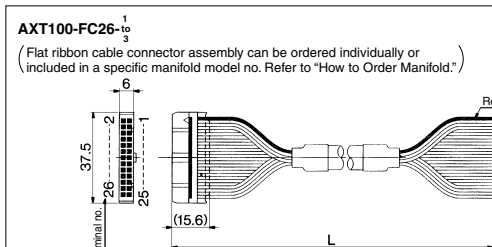

### Flat Ribbon Cable Connector Assembly

Cable length (L)	Assembly part no.	Note
1.5 m	AXT100-FC26-1	Cable 26 cores x 28AWG
3 m	AXT100-FC26-2	
5 m	AXT100-FC26-3	

\* For other commercial connectors, use a 26 pins type with strain relief conforming to MIL-C-83503.  
\* Cannot be used for transfer wiring.

### Connector manufacturers' example

- HIROSE ELECTRIC CO., LTD.
- Fujitsu Limited
- J.S.T. Mfg. Co., Ltd.
- 3M Japan Limited
- Japan Aviation Electronics Industry, Limited
- Oki Electric Cable Co., Ltd.

Note 1) Other than the above model, 10P, 16P, 20P are also available. Refer to page 418 for details.  
Note 2) Lengths other than the above are also available. Please contact SMC for details.

### Cable Assembly

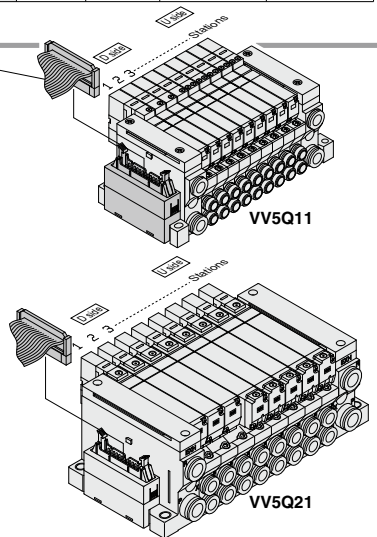

The total number of stations is tabulated starting from one on the D-side.

## How to Order Manifold

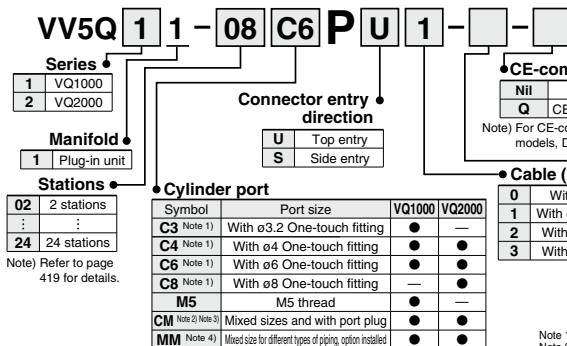

Note) Refer to page 419 for details.

- Note 1) Insert "L" (Top ported) or "B" (Bottom ported) for elbow type.  
Example) BB (Bottom ported elbow with ø6 One-touch fitting)  
Note 2) Indicate "LM" (Including upward, downward piping and mixed) for models with elbow fittings and mixed cylinder port sizes.  
Note 3) Indicate "Mixed sizes and with port plug" by means of the manifold specification sheet.  
Note 4) When selecting the mixed size for different types of piping, dual flow fitting assembly, or double check block (direct mounting), enter "MM" and give instructions in the manifold specification sheet.  
Note 5) Inch-size One-touch fittings are available. Refer to "Semi-standard" on page 420 for details.

Note) For CE-compliant models, DC-type only.



### Option

Symbol	Option	VQ1000	VQ2000
Nil	None	●	●
B (Note 2)	With back pressure check valve	●	●
D	DIN rail mounting	●	●
D0	With DIN rail bracket (Without DIN rail)	●	●
D□ (Note 3)	DIN rail length specified (□: Stations 02 to 24)	●	●
G1 (Note 4)	1 set of regulator unit	●	—
G2 (Note 4)	2 sets of regulator unit	●	—
G3 (Note 4)	3 sets of regulator unit	●	—
J□ (Note 5)	With ejector unit	●	—
K (Note 6)	Special wiring specifications (except double wiring)	●	●
N	With name plate	●	●
R (Note 7)	External pilot	●	●
S	Direct EXH outlet with built-in silencer	●	●

- Note 1) When two or more symbols are specified, indicate them alphabetically. Example) -BRS  
Note 2) Models with a suffix "-B" have check valves for prevention of back pressure at all manifold stations. When a back pressure check valve is desired, and is to be installed only in certain manifold stations, specify the mounting position by means of the manifold specification sheet.  
Note 3) The number of stations that may be displayed is longer than the manifold number of stations.  
Note 4) Specify the mounting position by means of the manifold specification sheet.  
Note 5) Refer to page 432 for details on with ejector unit. A combination of "J" and "N" is not available.  
Note 6) Specify the wiring specifications by means of the manifold specification sheet.  
Note 7) Indicate "R" for the valve with external pilot.  
Note 8) G1, G2, or G3 cannot be combined with N.

- SV
- SYJ
- SZ
- VF
- VP4
- VQ 1/2
- VQ 4/5
- VQC 1/2
- VQC 4/5
- VQZ
- SQ
- VFS
- VFR
- VQ7

● **Electrical Wiring Specifications**

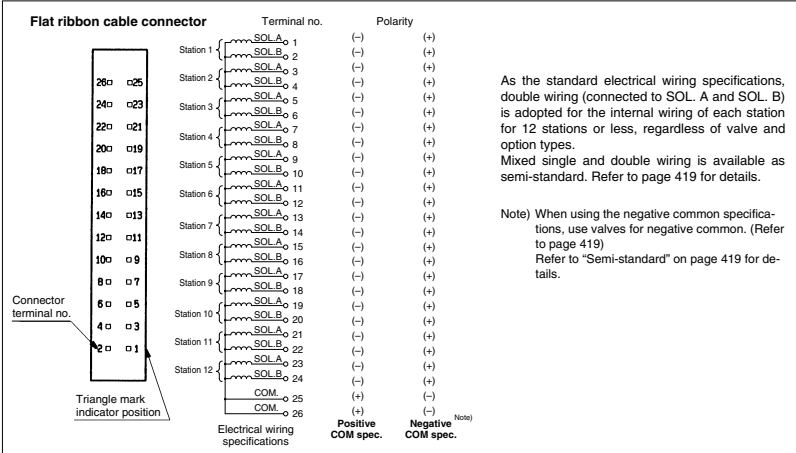

**How to Order Valves**

Note) For CE-compliant models, DC-type only. **CE** [Option]

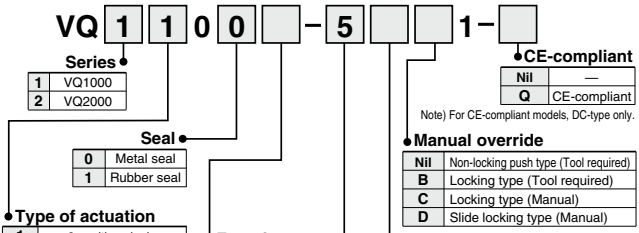

● **Type of actuation**

1	2-position single
2	2-position double
3	3-position closed center
4	3-position exhaust center
5	3-position pressure center
A	4-position dual port (N.C. +N.C.)
B	4-position dual port (N.O. +N.O.)
C	4-position dual port (N.C. +N.O.)

● **Function**

Symbol	Specifications	DC	AC
Nil	Standard (0.4 W)	<input type="radio"/> (Note 1)	<input type="radio"/> (Note 1)
B	High-speed response type (0.95 W)	<input type="radio"/>	<input type="radio"/>
K Note 2)	High-pressure type (1.0 MPa) (0.95 W)	<input type="radio"/>	<input type="radio"/>
N Note 3)	Negative common	<input type="radio"/>	<input type="radio"/>
R Note 5)	External pilot	<input type="radio"/>	<input type="radio"/>

● **Light/Surge voltage suppressor**

Nil	Yes
E Note)	None (Non-polar)

Note) A combination of "Function [N] (Negative common)" and [E] is unavailable. Since [E] has no polarity, it can also be used as a negative common. Selection of "Function [N]" is not required.

● **Coil voltage**

	CE-compliant
1	100 VAC (50/60 Hz) —
3	110 VAC (50/60 Hz) —
5	24 VDC ●
6	12 VDC ●

**Caution**  
Use the standard (DC) specification when continuously energizing for long periods of time.

Note 1) Refer to page 381 for power consumption of AC type.  
Note 2) Metal seal only.  
Note 3) Refer to "Semi-standard" on pages 419 and 420 for external pilot and negative common specifications.  
Note 4) When two or more symbols are specified, indicate them alphabetically. Combination of [B] and [K] is not possible.  
Note 5) Dual 3-port valve is not applicable.

**How to Order Manifold Assembly**

Specify the part numbers for valves and options together beneath the manifold base part number.

<Example>  
Flat ribbon cable kit with cable (3 m)  
VV5Q11-09C6PU2...1 set—Manifold base part no.  
● VQ1100-51 .....2 sets—Valve part no. (Stations 1 to 2)  
● VQ1200-51 .....4 sets—Valve part no. (Stations 3 to 8)  
● VQ1300-51 .....2 sets—Valve part no. (Stations 7 to 8)  
● VVQ1000-10A-1 .....1 set—Blanking plate part no. (Station 9)

Prefix the asterisk to the part nos. of the solenoid valve, etc.  
Write sequentially from the 1st station on the D-side. When part nos. written collectively are complicated, specify them by means of the manifold specification sheet.

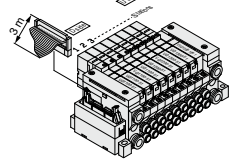

# P VQ1000/2000 Series

## Kit (Flat ribbon cable)

### VV5Q11

< >: AC  
The dashed lines indicate the DIN rail mounting [-D] and the side entry connection [-PS].

Applicable connector: Flat ribbon cable connector (26P)  
(Complies with MIL-C-83503)

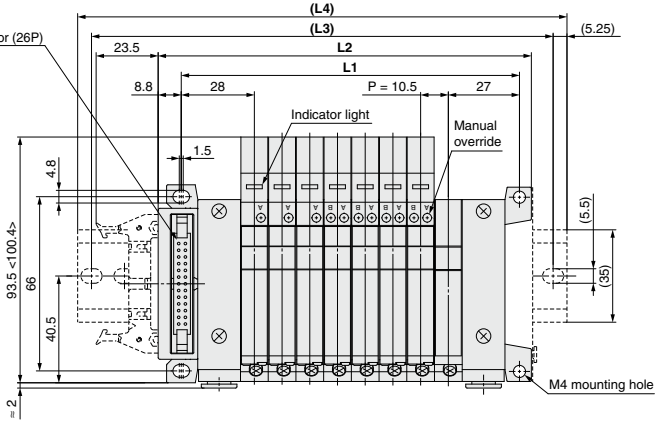
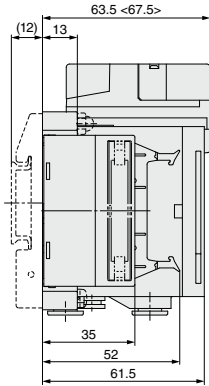

D side Stations 1 2 3 4 5 6 7 8 ... n U side

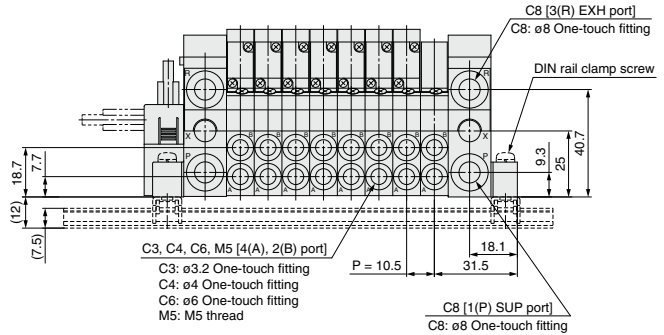

### Dimensions

Formula  $L1 = 10.5n + 44.5$ ,  $L2 = 10.5n + 57.5$  n: Station (Maximum 24 stations)

L	n	2	3	4	5	6	7	8	9	10	11	12	13	14	15	16	17	18	19	20	21	22	23	24
<b>L1</b>		65.5	76	86.5	97	107.5	118	128.5	139	149.5	160	170.5	181	191.5	202	212.5	223	233.5	244	254.5	265	275.5	286	296.5
<b>L2</b>		78.5	89	99.5	110	120.5	131	141.5	152	162.5	173	183.5	194	204.5	215	225.5	236	246.5	257	267.5	278	288.5	299	309.5
<b>(L3)</b>		112.5	125	125	137.5	150	162.5	175	187.5	187.5	200	212.5	225	225	237.5	250	262.5	275	287.5	287.5	300	312.5	325	337.5
<b>(L4)</b>		123	135.5	135.5	148	160.5	173	185.5	198	198	210.5	223	235.5	235.5	248	260.5	273	285.5	298	298	310.5	323	335.5	348

With ejector unit: Formula  $L1 = 10.5n + 28.7 + (\text{Number of ejector units} \times 26.7)$

$L2 = 10.5n + 41.3 + (\text{Number of ejector units} \times 26.7)$

$L4$  is  $L2$  plus about 30.

# VV5Q21

< >: AC  
The dashed lines indicate the DIN rail mounting [-D] and the side entry connection [-PS].

Applicable connector: Flat ribbon cable connector (26P)  
(Complies with MIL-C-83503)

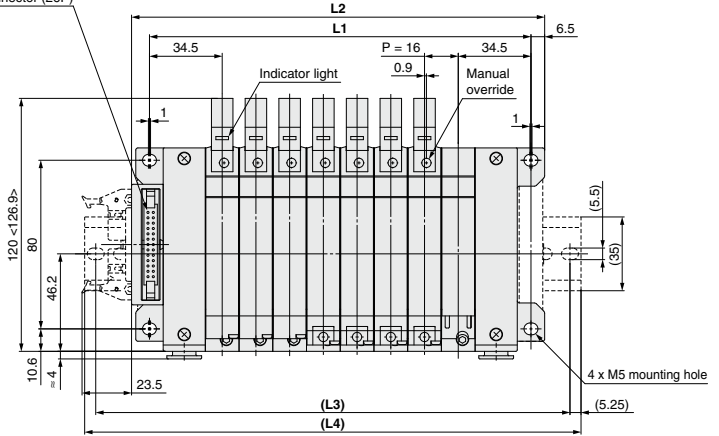
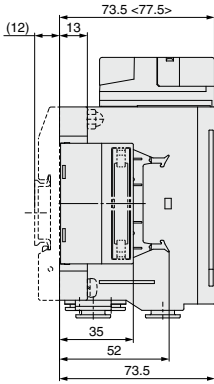

D side Stations -- 1 --- 2 --- 3 --- 4 --- 5 --- 6 --- 7 --- 8 --- n U side

Flat ribbon cable connector assembly (26P)  
AXT100-FC26-1: 1.5 m  
AXT100-FC26-2: 3 m  
AXT100-FC26-3: 5 m

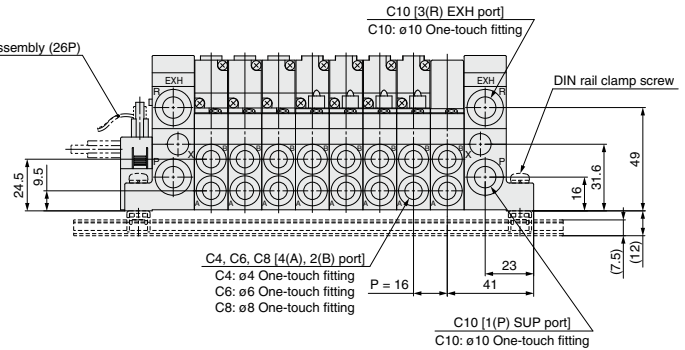

## Dimensions

Formula  $L1 = 16n + 53$ ,  $L2 = 16n + 68$  n: Station (Maximum 24 stations)

L	n	2	3	4	5	6	7	8	9	10	11	12	13	14	15	16	17	18	19	20	21	22	23	24
<b>L1</b>		85	101	117	133	149	165	181	197	213	229	245	261	277	293	309	325	341	357	373	389	405	421	437
<b>L2</b>		100	116	132	148	164	180	196	212	228	244	260	276	292	308	324	340	356	372	388	404	420	436	452
<b>(L3)</b>		125	150	162.5	175	187.5	212.5	225	237.5	262.5	275	287.5	300	312.5	337.5	350	362.5	387.5	400	412.5	425	450	462.5	475
<b>(L4)</b>		135.5	160.5	173	185.5	198	223	235.5	248	273	285.5	298	310.5	323	348	360.5	373	398	410.5	423	435.5	460.5	473	485.5

- SV
- SYJ
- SZ
- VF
- VP4
- VQ 1/2**
- VQ 4/5
- VQC 1/2
- VQC 4/5
- VQZ
- SQ
- VFS
- VFR
- VQ7

# G

## VQ1000/2000 Series Kit (Flat ribbon cable with terminal block)

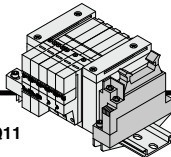

VV5Q11

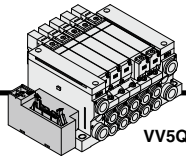

VV5Q21

- Terminal block for power supply equipped with a 20 pins flat ribbon cable connection for rationalized connection of valves.
- Solenoid valves and power supply can be connected by the same cable to a specific output unit that requires power supply from the output section to the internal circuit.
- Maximum stations are 16.

### Manifold Specifications

Series	Piping specifications			Applicable stations
	Piping direction	Port size	Port size	
VQ1000	Side	C8	4(A), 2(B)	Max. 16 stations
VQ2000	Side	C10	C4, C6, C8	Max. 16 stations

### Flat Ribbon Cable (20 Pins)

#### Cable Assembly

AXT100-FC20-<sup>1</sup>/<sub>3</sub>

(Flat ribbon cable connector assembly can be ordered individually or included in a specific manifold model no. Refer to "How to Order Manifold.")

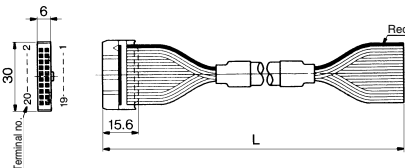

#### Flat Ribbon Cable Connector Assembly

Cable length (L)	Assembly part no.	Note
1.5 m	AXT100-FC20-1	Cable 20 cores x 28AWG
3 m	AXT100-FC20-2	
5 m	AXT100-FC20-3	

- \* For other commercial connectors, use a 20 pins type with strain relief conforming to MIL-C-83503.
- \* Cannot be used for transfer wiring.

#### Connector manufacturers' example

- HIROSE ELECTRIC CO., LTD.
- Japan Aviation Electronics Industry, Limited
- 3M Japan Limited
- Oki Electric Cable Co., Ltd.
- Fujitsu Limited
- J.S.T. Mfg. Co., Ltd.

(Note) Lengths other than the above are also available. Please contact SMC for details.

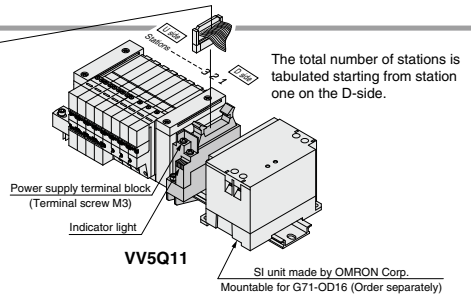

The total number of stations is tabulated starting from station one on the D-side.

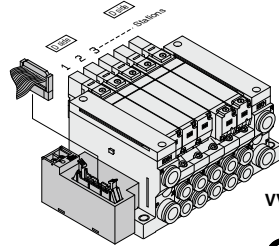

VV5Q21



### How to Order Manifold

VV5Q 1 1 - 08 C6 G - - -

**Series**

1	VQ1000
2	VQ2000

**Manifold**

1	Plug-in unit
---	--------------

**Connector entry direction, Top entry**

Nil	VQ1000
U	VQ2000

**Cable (Length)**

0	Without cable
1	Cable length 1.5 m
2	Cable length 3 m
3	Cable length 5 m

#### Cylinder port

Symbol	Port size	VQ1000	VQ2000
<b>C3</b> (Note 1)	With ø3.2 One-touch fitting	●	—
<b>C4</b> (Note 1)	With ø4 One-touch fitting	●	●
<b>C6</b> (Note 1)	With ø6 One-touch fitting	●	●
<b>C8</b> (Note 1)	With ø8 One-touch fitting	—	●
<b>M5</b>	M5 thread	●	—
<b>CM</b> (Note 2, Note 3)	Mixed sizes and with port plug	●	●
<b>MM</b> (Note 4)	Mixed size for different types of piping, option installed	●	●

- Note 1) Insert "L" (Top ported) or "B" (Bottom ported) for elbow type. Example) B6 (Bottom ported elbow with ø6 One-touch fitting)
- Note 2) Indicate "LM" (including upward, downward piping and mixed) for models with elbow fittings and mixed cylinder port sizes.
- Note 3) Indicate "Mixed sizes and with port plug" by means of the manifold specification sheet.
- Note 4) When selecting the mixed size for different types of piping, dual flow fitting assembly, or double check block (direct mounting), enter "MM" and give instructions in the manifold specification sheet.
- Note 5) Inch-size One-touch fittings are available. Refer to "Semi-standard" on page 420 for details.

#### Option

Symbol	Option	VQ1000	VQ2000
<b>Nil</b>	None	●	●
<b>B</b> (Note 2)	With back pressure check valve	●	●
<b>D</b>	DIN rail mounting	●	●
<b>D0</b>	With DIN rail bracket (Without DIN rail)	●	●
<b>D□</b> (Note 3)	DIN rail length specified (□: Stations 02 to 24)	●	●
<b>G1</b> (Note 4)	1 set of regulator unit	●	—
<b>G2</b> (Note 4)			
<b>G3</b> (Note 4)			
<b>J□</b> (Note 5)	With ejector unit	●	—
<b>K</b> (Note 6)	Special wiring specifications (Except double wiring)	●	●
<b>N</b>	With name plate	●	●
<b>R</b> (Note 7)	External pilot	●	●
<b>S</b>	Direct EXH outlet with built-in silencer	●	●

- Note 1) When two or more symbols are specified, indicate them alphabetically. Example) -BRS
- Note 2) Models with a suffix "-B" have check valves for prevention of back pressure at all manifold stations. When a back pressure check valve is desired, and is to be installed only in certain manifold stations, specify the mounting position by means of the manifold specification sheet.
- Note 3) The number of stations that may be displayed is longer than the manifold number of stations.
- Note 4) Specify the mounting position by means of the manifold specification sheet.
- Note 5) Refer to page 432 for details on with ejector unit. A combination of "J" and "TV" is not available.
- Note 6) Specify the wiring specifications by means of the manifold specification sheet.
- Note 7) Indicate "R" for the valve with external pilot.
- Note 8) G1, G2, or G3 cannot be combined with N.

SV  
 SYJ  
 SZ  
 VF  
 VP4  
 VQ 1/2  
 VQ 4/5  
 VQC 1/2  
 VQC 4/5  
 VQZ  
 SQ  
 VFS  
 VFR  
 VQ7

• Connector Assembly

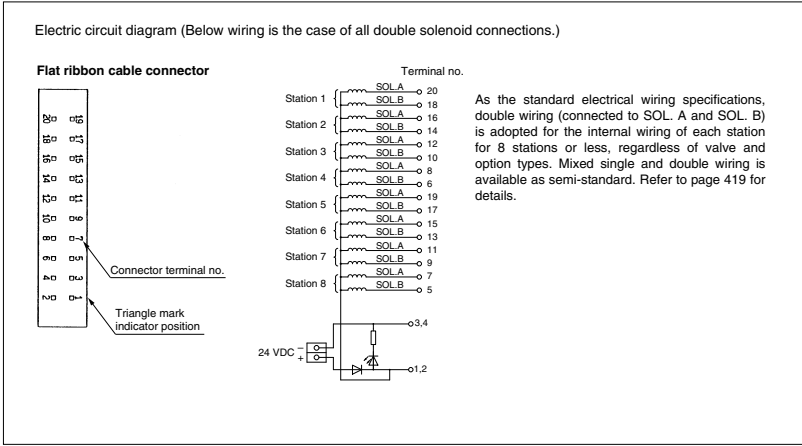

How to Order Valves

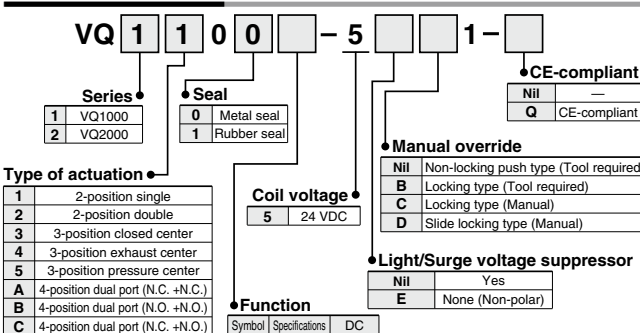

Symbol	Specifications	DC
Nil	Standard	(0.4 W) ○
B	High-speed response type	(0.95 W) ○
K	High-pressure type (1.0 MPa)	(0.95 W) ○
R	External pilot	○

Note 1) Metal seal only  
 Note 2) Refer to "Semi-standard" on page 420 for external pilot specifications.  
 Note 3) When two or more symbols are specified, indicate them alphabetically. Combination of [B] and [K] is not possible.  
 Note 4) Dual 3-port valve is not applicable.



How to Order Manifold Assembly

Specify the part numbers for valves and options together beneath the manifold base part number.

**<Example>**  
 Flat ribbon cable kit with terminal block with cable (3 m)  
**VV5Q11-08C6G2 ...1 set—Manifold base part no.**  
 \*VQ1100-51 .....4 sets—Valve part no. (Stations 1 to 4)  
 \*VQ1200-51 .....1 set—Valve part no. (Station 5)  
 \*VQ1300-51 .....3 sets—Valve part no. (Stations 6 to 8)

Write sequentially from the 1st station on the D-side.  
 When part nos. written collectively are complicated, specify them by means of the manifold specification sheet.

Prefix the asterisk to the part nos. of the solenoid valve, etc.

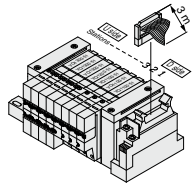

# G VQ1000/2000 Series

## Kit (Flat ribbon cable with terminal block)

### VV5Q11

The dashed lines and dimensions in parentheses indicate DIN rail mounting [-D].

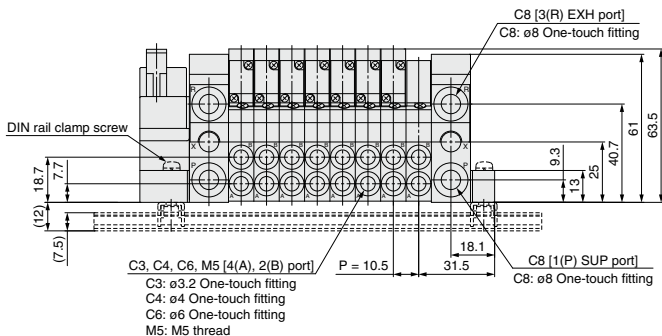
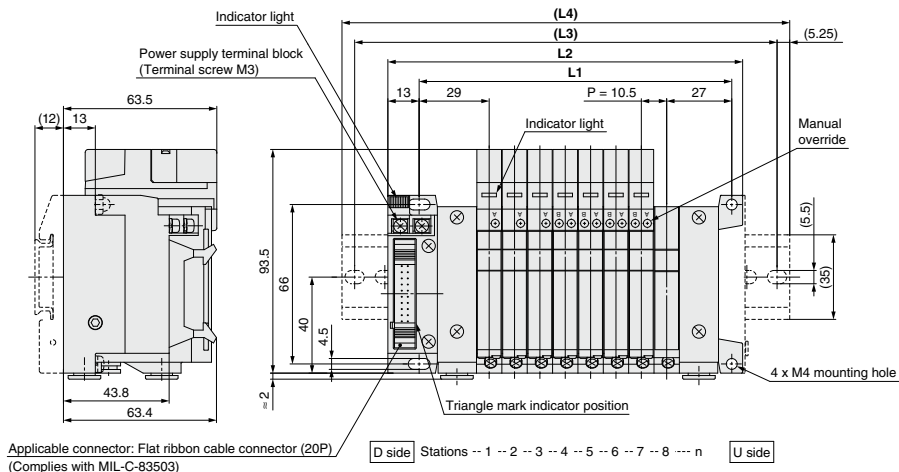

### Dimensions

Formula  $L1 = 10.5n + 45.5$ ,  $L2 = 10.5n + 63$  n: Station (Maximum 16 stations)

L	n	2	3	4	5	6	7	8	9	10	11	12	13	14	15	16
<b>L1</b>		66.5	77	87.5	98	108.5	119	129.5	140	150.5	161	171.5	182	192.5	203	213.5
<b>L2</b>		84	94.5	105	115.5	126	136.5	147	157.5	168	178.5	189	199.5	210	220.5	231
<b>(L3)</b>		112.5	125	125	137.5	150	162.5	175	187.5	187.5	200	212.5	225	237.5	250	262.5
<b>(L4)</b>		123	135.5	135.5	148	160.5	173	185.5	198	198	210.5	223	235.5	248	260.5	273

With ejector unit: Formula  $L1 = 10.5n + 29.7 +$  (Number of ejector units x 26.7)

$L2 = 10.5n + 46.8 +$  (Number of ejector units x 26.7)

L4 is L2 plus about 30.



# VV5Q21

The dashed lines indicate DIN rail mounting [-D] (with DIN rail mounting bracket).

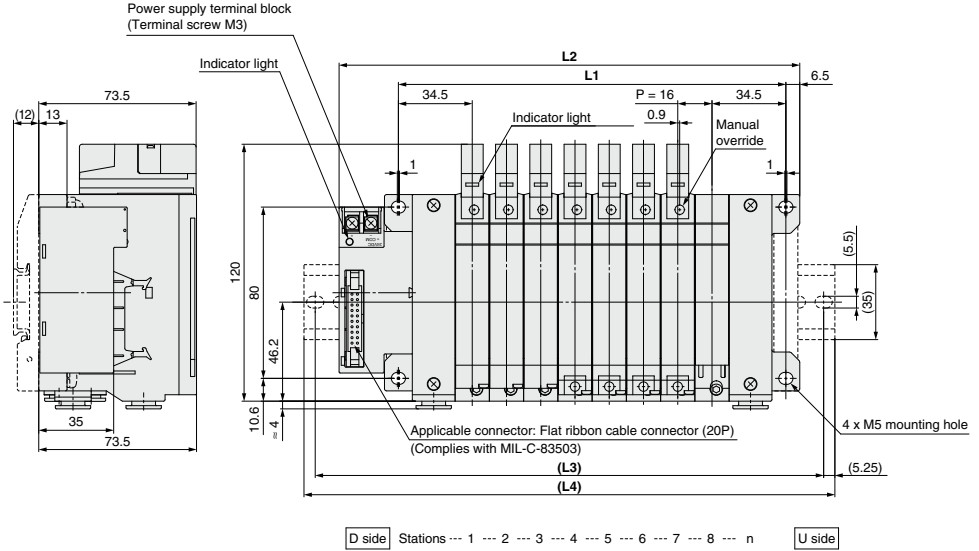

Flat ribbon cable connector assembly (20P)  
 AXT100-FC20-1: 1.5 m  
 AXT100-FC20-2: 3 m  
 AXT100-FC20-3: 5 m

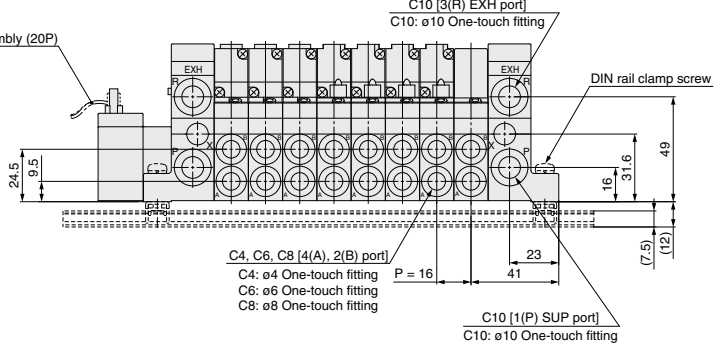

## Dimensions

Formula  $L1 = 16n + 53$ ,  $L2 = 16n + 87$  n: Station (Maximum 16 stations)

L	n	2	3	4	5	6	7	8	9	10	11	12	13	14	15	16
<b>L1</b>		85	101	117	133	149	165	181	197	213	229	245	261	277	293	309
<b>L2</b>		119	135	151	167	183	199	215	231	247	263	279	295	311	327	343
<b>(L3)</b>		150	162.5	175	187.5	212.5	225	237.5	262.5	275	287.5	300	325	337.5	350	362.5
<b>(L4)</b>		160.5	173	185.5	198	223	235.5	248	273	285.5	298	310.5	335.5	348	360.5	373

- SV
- SYJ
- SZ
- VF
- VP4
- VQ 1/2**
- VQ 4/5
- VQC 1/2
- VQC 4/5
- VQZ
- SQ
- VFS
- VFR
- VQ7

# T VQ1000/2000 Series Kit (Terminal block box)

**IP65 compliant**

- This kit has a small terminal block inside a junction box. The electrical entry port (VQ1000: G 1/2, VQ2000: G 3/4) permits connection of conduit fittings.
- Maximum stations: 24 (VQ1000), 20 (VQ2000)
- Enclosure: Dust-tight, Water-jet-proof (IP65) compatible (VQ2000 series)

## Manifold Specifications

Series	Piping specifications			Applicable stations
	Piping direction	Port size	1(P), 3(R), 4(A), 2(B)	
VQ1000	Side	C8	C3, C4, C6, M5	Max. 24 stations
VQ2000	Side	C10	C4, C6, C8	Max. 20 stations

## Terminal Block Connection (VQ1000)

Open the terminal block cover to connect the wires to the terminal block.

### Step 1. Removing the terminal block cover

Loosen the screws on the terminal block cover and open it in the direction shown by the arrow. The cover can then be removed from the terminal block.

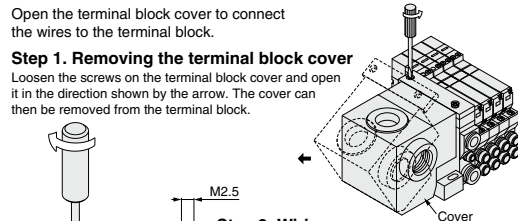

### Step 2. Wiring

The diagram on the left shows the terminal block wiring schematic. All stations are provided with double solenoid wiring. Insert each lead wire into the terminal opening and tighten the screw directly above.

How to connect is inserting the lead wire into the terminal window, then tighten the screw on the top. (Tightening torque: 0.25 to 0.35 N·m)

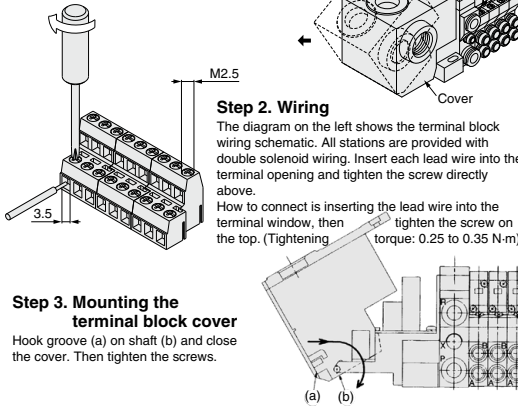

### Step 3. Mounting the terminal block cover

Hook groove (a) on shaft (b) and close the cover. Then tighten the screws.

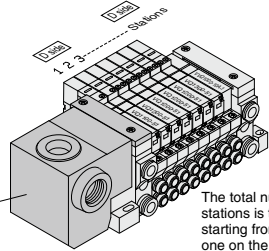
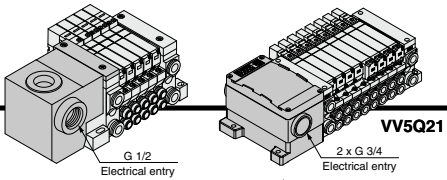

The total number of stations is tabulated starting from station one on the D-side.

## Electrical Wiring Specifications: VQ1000

Terminal no.	Polarity
COM	COM (+) (-)
Station 1	SOL A 1A (-) (+)
Station 1	SOL B 1B (-) (+)
Station 2	SOL A 2A (-) (+)
Station 2	SOL B 2B (-) (+)
Station 3	SOL A 3A (-) (+)
Station 3	SOL B 3B (-) (+)
Station 4	SOL A 4A (-) (+)
Station 4	SOL B 4B (-) (+)
Station 5	SOL A 5A (-) (+)
Station 5	SOL B 5B (-) (+)
Station 6	SOL A 6A (-) (+)
Station 6	SOL B 6B (-) (+)
Station 7	SOL A 7A (-) (+)
Station 7	SOL B 7B (-) (+)
Station 8	SOL A 8A (-) (+)
Station 8	SOL B 8B (-) (+)
Station 9	SOL A 9A (-) (+)
Station 9	SOL B 9B (-) (+)
Station 10	SOL A 10A (-) (+)
Station 10	SOL B 10B (-) (+)
Station 11	SOL A 11A (-) (+)
Station 11	SOL B 11B (-) (+)
Station 12	SOL A 12A (-) (+)
Station 12	SOL B 12B (-) (+)
COM	COM (+) (-)

1st row-2nd row — 3rd row

The quantity of terminal blocks used depends on the number of manifold stations.

Manifold	Terminal block
2 to 8 stations	2 rows
9 to 12 stations	3 rows

As the standard electrical wiring specifications, double wiring (connected to SOL A and SOL B) is adopted for the internal wiring of each station for 12 stations or less, regardless of valve and option types. Mixed single and double wiring is available as semi-standard. Refer to page 419 for details.

Note) When using the negative common specifications, use valves for negative common. Refer to "Semi-standard" on page 419 for details.

Note) Positive COM spec. COM spec. Negative COM spec. COM spec.

## How to Order Manifold

VV5Q 1 1 - 08 C6 T 0 - - -

**Series**

- 1 VQ1000
- 2 VQ2000

**Manifold**

- 1 Plug-in unit

**Stations**

- 02 2 stations
- 24 24 stations

**Cylinder port**

Symbol	Port size	VQ1000	VQ2000
C3	With ø3.2 One-touch fitting	●	—
C4	With ø4 One-touch fitting	●	●
C6	With ø6 One-touch fitting	●	●
C8	With ø8 One-touch fitting	—	●
M5	M5 thread	—	—
CM	Mixed sizes and with port plug	●	●
MM	Mixed size for different types of piping, option installed	●	●

**CE-compliant**

- Nil —
- Q CE-compliant

Note) For CE-compliant models, DC-type only.

Note) For CE-compliant models, DC-type only. [Option]

## Option

Symbol	Option	VQ1000	VQ2000
Nil	None	●	●
B Note 2)	With back pressure check valve	●	●
D	DIN rail mounting	●	●
DD	With DIN rail bracket (Without DIN rail)	●	●
D□ Note 6)	DIN rail length specified (□: Stations 02 to 24)	●	●
G1 Note 4)	1 set of regulator unit	●	—
G2 Note 4)	2 sets of regulator unit	●	—
G3 Note 4)	3 sets of regulator unit	●	—
J□ Note 5)	With ejector unit	●	—
K Note 6)	Special wiring spec. (Except double wiring)	●	●
N	With name plate	●	●
R Note 7)	External pilot	●	●
S	Direct EXH outlet with built-in silencer	●	●
W Note 9)	Enclosure: Dust-tight, Water-jet-proof (IP65)	●	●

- Note 1) When two or more symbols are specified, indicate them alphabetically. Example) -BRS
- Note 2) Models with a suffix "-B" have check valves for prevention of back pressure at all manifold stations. When a back pressure check valve is desired, and is to be installed only in certain manifold stations, specify the mounting position by means of the manifold specification sheet.
- Note 3) The number of stations that may be displayed is longer than the manifold number of stations.
- Note 4) Specify the mounting position by means of the manifold specification sheet.
- Note 5) Refer to page 432 for details on with ejector unit. A combination of "J" and "N" is not available.
- Note 6) Specify the wiring specifications by means of the manifold specification sheet.
- Note 7) Indicate "R" for the valve with external pilot.
- Note 8) G1, G2, or G3 cannot be combined with N.
- Note 9) When used in combination with the direct EXH outlet with built-in silencer type, keep the exhaust port from coming into direct contact with water or other liquids.

• Terminal Block Wiring (VQ2000)

Open the terminal block cover to connect the wires to the terminal block.

**Step 1. Removing the terminal block cover**

Loosen mounting screws (4 pcs.) on the terminal block cover and remove the cover.

**Step 2. Wiring**

Loosen screws on the terminal block, connect wiring and complete it by tightening screws. (Tightening torque: 0.5 to 0.7 N·m)

The diagram on the right shows the terminal block wiring. All stations are provided with double wiring regardless of the valves which are mounted.

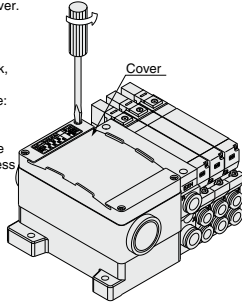
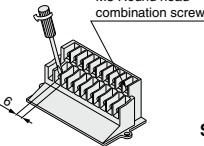

**Step 3. Mounting the terminal block cover**

Securely tighten the screws after confirming that the gasket is installed correctly. (Tightening torque: 0.7 to 1.2 N·m)

Applicable crimped terminal:  
1.25-3S, 1.25Y-3,  
1.25Y-3N, 1.25Y-3.5

• Special Wiring Specifications: VQ2000

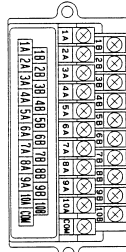

Station no.	Terminal	Polarity
Station 1	SOL A 1A	(-) (+)
	SOL B 1B	(-) (+)
Station 2	SOL A 2A	(-) (+)
	SOL B 2B	(-) (+)
Station 3	SOL A 3A	(-) (+)
	SOL B 3B	(-) (+)
Station 4	SOL A 4A	(-) (+)
	SOL B 4B	(-) (+)
Station 5	SOL A 5A	(-) (+)
	SOL B 5B	(-) (+)
Station 6	SOL A 6A	(-) (+)
	SOL B 6B	(-) (+)
Station 7	SOL A 7A	(-) (+)
	SOL B 7B	(-) (+)
Station 8	SOL A 8A	(-) (+)
	SOL B 8B	(-) (+)
Station 9	SOL A 9A	(-) (+)
	SOL B 9B	(-) (+)
Station 10	SOL A 10A	(-) (+)
	SOL B 10B	(-) (+)
	COM.	(+) (-)

As the standard electrical wiring specifications, double wiring (connected to SOL A and SOL B) is adopted for the internal wiring of each station for 10 stations or less, regardless of valve and option types. Mixed single and double wiring is available as semi-standard. Refer to page 419 for details.

Note) When using the negative common specifications, use valves for negative common.

Refer to "Semi-standard" on page 419 for details.

Note)  
Positive Negative  
COM spec. COM spec.

How to Order Valves

Note) For CE-compliant models, DC-type only.



[Option]

VQ 1 1 0 0 - 5 - - - 1 -

Series

1	VQ1000
2	VQ2000

Type of actuation

1	2-position single
2	2-position double
3	3-position closed center
4	3-position exhaust center
5	3-position pressure center
A	4-position dual port (N.C. +N.C.)
B	4-position dual port (N.O. +N.O.)
C	4-position dual port (N.C. +N.O.)

Seal

0	Metal seal
1	Rubber seal

Function

Symbol	Specifications	DC	AC
Nil	Standard	(0.4 W)	○ (Note 1)
		○	
B	High-speed response type	(0.95 W)	○
		○	—
K (Note 2)	High-pressure type (1.0 MPa)	(0.95 W)	—
		○	—
N (Note 3)	Negative common	○	—
		○	—
R (Note 3)	External pilot	○	○
		○	○

Coil voltage	CE-compliant
1 100 VAC (50/60 Hz)	—
3 110 VAC (50/60 Hz)	—
5 24 VDC	●
6 12 VDC	●

CE-compliant

Nil	—
Q	CE-compliant

Note) For CE-compliant models, DC-type only.

Enclosure

Nil	Dust-protected
W (Note)	Dust-tight, Water-jet-proof (IP65)

Note) VQ2000 only

Manual override

Nil	Non-locking push type (Tool required)
B	Locking type (Tool required)
C	Locking type (Manual)
D	Slide locking type (Manual)

Light/Surge voltage suppressor

Light/Surge voltage suppressor	Yes	Note)
Nil	Yes	Note) A combination of "Function [N] (Negative common)" and [E] is unavailable. Since [E] has no polarity, it can also be used as a negative common. Selection of "Function [N]" is not required.
E (Note)	None	

How to Order Manifold Assembly

Specify the part numbers for valves and options together beneath the manifold base part number.

<Example>

Terminal block box kit  
**VV5Q11-08C6T0** ··· 1 set—Manifold base part no.  
 \***VQ1100-51** ······· 2 sets—Valve part no. (Stations 1 to 2)  
 \***VQ1200-51** ······· 4 sets—Valve part no. (Stations 3 to 6)  
 \***VQ1300-51** ······· 1 set—Valve part no. (Station 7)  
 \***VVQ1000-10A-1** ··· 1 set—Blanking plate part no. (Station 8)

Prefix the asterisk to the part nos. of the solenoid valve, etc.

Write sequentially from the 1st station on the D-side. When part nos. written collectively are complicated, specify them by means of the manifold specification sheet.

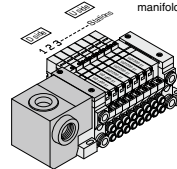

Note 1) Refer to page 381 for power consumption of AC type.  
 Note 2) Metal seal only  
 Note 3) Refer to "Semi-standard" on pages 419 and 420 for external pilot and negative common specifications.  
 Note 4) When two or more symbols are specified, indicate them alphabetically. Combination of [B] and [K] is not possible.  
 Note 5) Dual 3-port valve is not applicable.

⚠ Caution

Use the standard (DC) specification when continuously energizing for long periods of time.



SV  
 SYJ  
 SZ  
 VF  
 VP4  
 VQ 1/2  
 VQ 4/5  
 VQC 1/2  
 VQC 4/5  
 VQZ  
 SQ  
 VFS  
 VFR  
 VQ7

# T VQ1000/2000 Series

## Kit (Terminal block box)

### VV5Q11

< >: AC

The dashed lines and dimensions in parentheses indicate DIN rail mounting [-D].

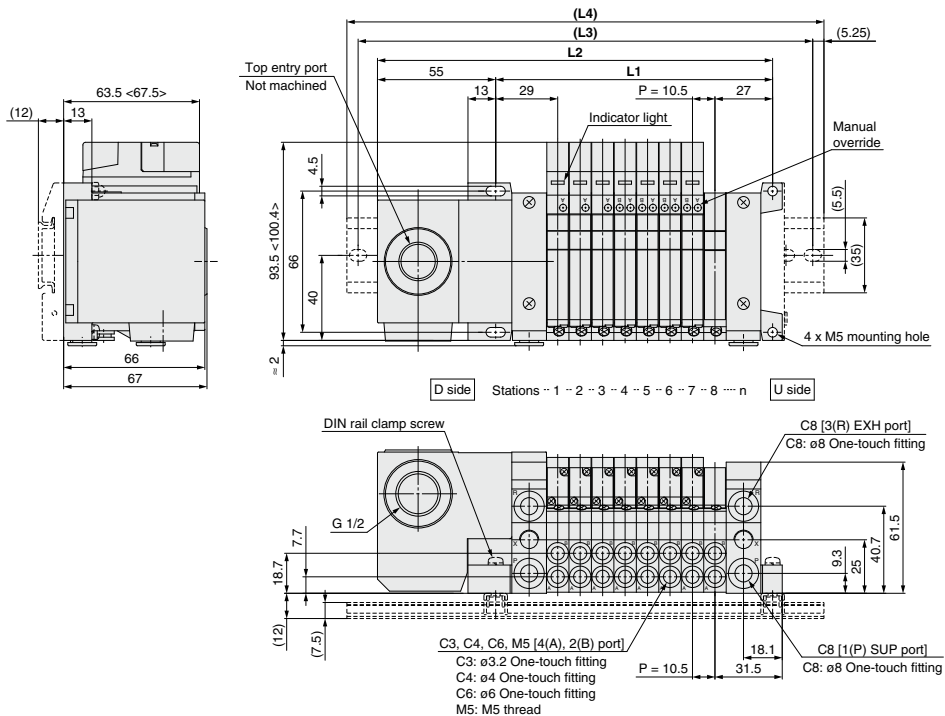

#### Dimensions

Formula L1 = 10.5n + 45.5, L2 = 10.5n + 105    n: Station (Maximum 24 stations)

L	n	2	3	4	5	6	7	8	9	10	11	12	13	14	15	16	17	18	19	20	21	22	23	24
<b>L1</b>		66.5	77	87.5	98	108.5	119	129.5	140	150.5	161	171.5	182	192.5	203	213.5	224	234.5	245	255.5	266	276.5	287	297.5
<b>L2</b>		126	136.5	147	157.5	168	178.5	189	199.5	210	220.5	231	241.5	252	262.5	273	283.5	294	304.5	315	325.5	336	346.5	357
<b>(L3)</b>		150	162.5	175	187.5	197.5	200	212.5	225	237.5	250	262.5	262.5	275	287.5	300	312.5	325	325	337.5	350	362.5	375	387.5
<b>(L4)</b>		160.5	173	185.5	198	198	210.5	223	235.5	248	260.5	273	273	285.5	298	310.5	323	335.5	335.5	348	360.5	373	385.5	398

With ejector unit: Formula L1 = 10.5n + 29.7 + (Number of ejector units x 26.7)

L2 = 10.5n + 88.8 + (Number of ejector units x 26.7)

L4 is L2 plus about 30.

# VV5Q21

< >: AC

The dashed lines indicate DIN rail mounting [-D] (with DIN rail mounting bracket).

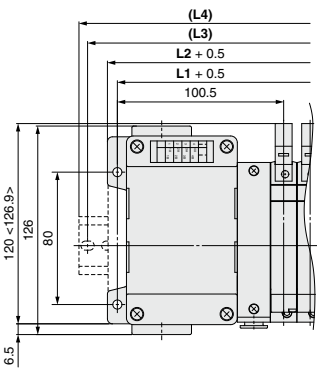
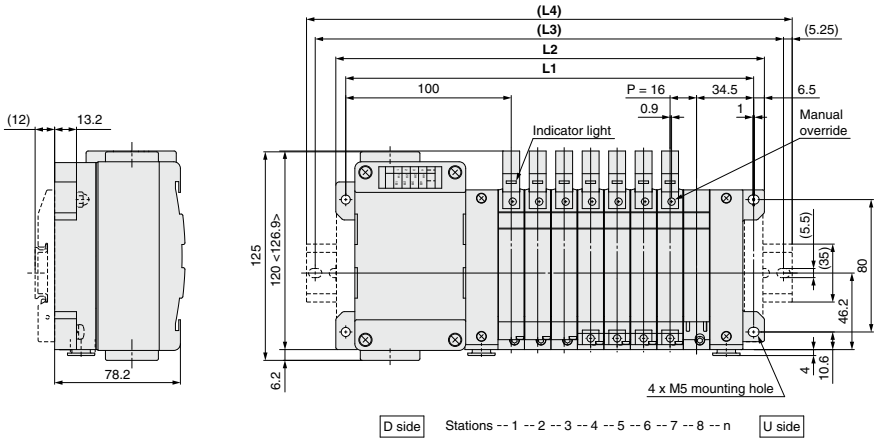

Dust-tight, Water-jet-proof

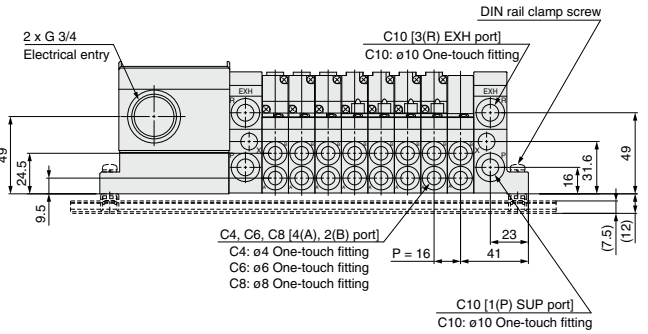

## Dimensions

Formula L1 = 16n + 118.5, L2 = 16n + 131 n: Station (Maximum 20 stations)

L	n	2	3	4	5	6	7	8	9	10	11	12	13	14	15	16	17	18	19	20
<b>L1</b>		150.5	166.5	182.5	198.5	214.5	230.5	246.5	262.5	278.5	294.5	310.5	326.5	342.5	358.5	374.5	390.5	406.5	422.5	438.5
<b>L2</b>		163	179	195	211	227	243	259	275	291	307	323	339	355	371	387	403	419	435	451
<b>(L3)</b>		187.5	200	225	237.5	250	262.5	287.5	300	312.5	337.5	350	362.5	375	400	412.5	425	450	462.5	475
<b>(L4)</b>		198	210.5	235.5	248	260.5	273	298	310.5	323	348	360.5	373	385.5	410.5	423	435.5	460.5	473	485.5

- SV
- SYJ
- SZ
- VF
- VP4
- VQ 1/2
- VQ 4/5
- VQC 1/2
- VQC 4/5
- VQZ
- SQ
- VFS
- VFR
- VQ7

# VQ1000/2000 Series Kit (Lead wire)

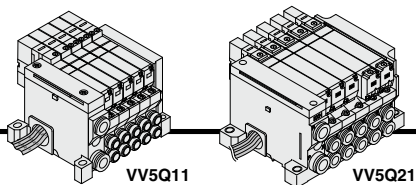

## IP65 compliant

- Direct electrical entry. Models with one or more stations are available.
- (SUP) and (EXH) ports are provided on one side for further space savings.
- Maximum stations are 8.
- Enclosure: Dust-tight, Water-jet-proof (IP65) compatible (VQ2000 series)

## Wiring Specifications: Positive COM ●

Three lead wires are attached to each station regardless of the type of valve which is mounted.  
The red wire is for COM connection.

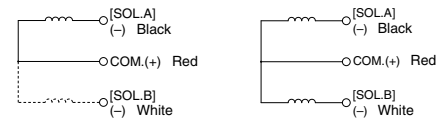

Single solenoid

Double solenoid

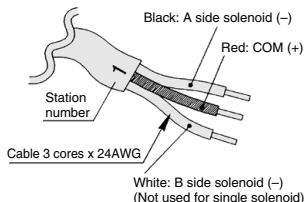

Use any of the below cable lead wire assembly to change the lead wire length:

### Lead wire assembly with connector

Lead wire length	Part no.
0.6 m	VVQ1000-84A-6-*
1.5 m	VVQ1000-84A-15-*
3 m	VVQ1000-84A-30-*

\* Station number 1 to 8

## Manifold Specifications

Series	Piping specifications			Applicable stations
	Piping direction	Port size	Port size	
VQ1000	Side	C8	4(A), 2(B)	Max. 8 stations
VQ2000	Side	C10	C6, C8	Max. 8 stations

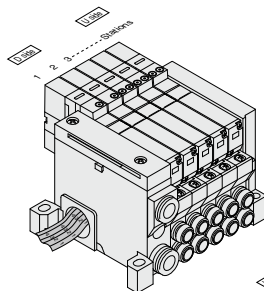

VV5Q11

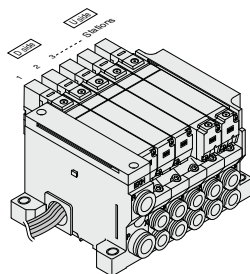

VV5Q21

The total number of stations is tabulated on the D-side.

## How to Order Manifold

Note) For CE-compliant models, DC-type only.

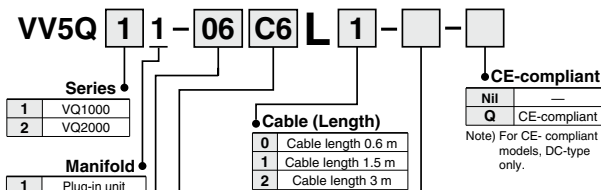

### Option

Symbol	Option	VQ1000	VQ2000
Nil	None	●	●
2 (Note 8)	200/220 VAC models (F/L kit only)	●	●
B (Note 2)	With back pressure check valve	●	●
D	DIN rail mounting	●	●
D0	With DIN rail bracket (Without DIN rail)	●	●
D□ (Note 3)	DIN rail length specified (□: Stations 02 to 24)	●	●
G□ (Note 3)	1 set of regulator unit	●	—
G2 (Note 4)	2 sets of regulator unit	●	—
G3 (Note 4)	3 sets of regulator unit	●	—
J□ (Note 5)	With ejector unit	●	—
N	With name plate	●	●
R (Note 6)	External pilot	●	●
S	Direct EXH outlet with built-in silencer	●	●
W (Note 8)	Enclosure: Dust-tight, Water-jet-proof (IP65)	●	●

- Note 1) When two or more symbols are specified, indicate them alphabetically. Example) -BRS  
 Note 2) Models with a suffix "B" have check valves for prevention of back pressure at all manifold stations. When a back pressure check valve is desired, and is to be installed only in certain manifold stations, specify the mounting position by means of the manifold specification sheet.  
 Note 3) The number of stations that may be displayed is longer than the manifold number of stations.  
 Note 4) Specify the mounting position by means of the manifold specification sheet.  
 Note 5) Refer to page 432 for details on with ejector unit. A combination of "J" and "N" is not available.  
 Note 6) Indicate "R" for the valve with external pilot.  
 Note 7) G1, G2, or G3 cannot be combined with N.  
 Note 8) A combination of "2" and "W" is unavailable. When the compatibility with IP65 of the 200 and 220 VAC specifications is required, select only "W".  
 Note 9) When used in combination with the direct EXH outlet with built-in silencer, keep the exhaust port from coming into direct contact with water or other liquids.

Note) For negative common specifications, refer to "Semi-standard" on page 419.

- Note 1) Insert "L" (Top ported) or "B" (Bottom ported) for elbow type.  
 Example) B6 (Bottom ported elbow with ø6 One-touch fitting)  
 Note 2) Indicate "LM" (Including upward, downward piping and mixed) for models with elbow fittings and mixed cylinder port sizes.  
 Note 3) Indicate "Mixed sizes and with port plug" by means of the manifold specification sheet.  
 Note 4) When selecting the mixed size for different types of piping, dual flow fitting assembly, or double check block (direct mounting), enter "MM" and give instructions in the manifold specification sheet.  
 Note 5) Inch-size One-touch fittings are available. Refer to "Semi-standard" on page 420 for details.

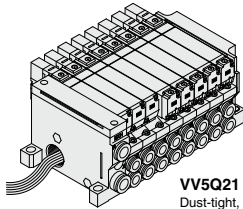

**VV5Q21**  
Dust-tight, Water-jet-proof

• **Wiring Specifications: Negative COM (Semi-standard)**

Three lead wires are attached to each station regardless of the type of valve which is mounted.  
The black wire is for COM connection.

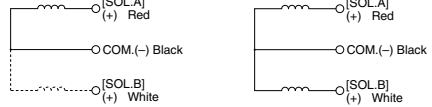

Single solenoid

Double solenoid

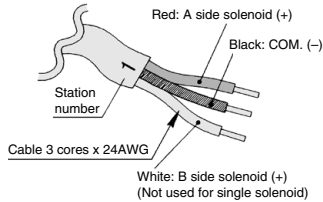

**Lead wire assembly with connector**

Lead wire length	Part no.
0.6 m	VVQ1000-84AN-6-*
1.5 m	VVQ1000-84AN-15-*
3 m	VVQ1000-84AN-30-*

\* Station number 1 to 8

Note) When using the negative common specifications, use valves for negative common. For negative common specifications, refer to "Semi-standard" on page 419.

**How to Order Valves**

Note) For CE-compliant models, DC-type only.

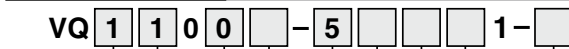

- Series**
- 1 VQ1000
  - 2 VQ2000
- Seal**
- 0 Metal seal
  - 1 Rubber seal
- Type of actuation**
- 1 2-position single
  - 2 2-position double
  - 3 3-position closed center
  - 4 3-position exhaust center
  - 5 3-position pressure center
  - A 4-position dual port (N.C. +N.C.)
  - B 4-position dual port (N.O. +N.O.)
  - C 4-position dual port (N.C. +N.O.)

**Function**

Symbol	Specifications	DC	AC
Nil	Standard	(0.4 W) ○ (Note 1)	○ (Note 1)
B	High-speed response type	(0.95 W) ○	—
K (Note 2)	High-pressure type (1.0 MPa)	(0.95 W) ○	—
N (Note 3)	Negative common	○	—
R (Note 3) (Note 5)	External pilot	○	○

Note 1) Refer to page 381 for power consumption of AC type.  
Note 2) Metal seal only  
Note 3) For external pilot and negative common specifications, refer to "Semi-standard" on pages 419 and 420.  
Note 4) When two or more symbols are specified, indicate them alphabetically. Combination of [B] and [K] is not possible.  
Note 5) Dual 3-port valve is not applicable.

- CE-compliant**
- Nil —
  - Q CE-compliant
- Note) For CE-compliant models, DC-type only.
- Enclosure**
- Nil Dust-protected
  - W (Note) Dust-tight, Water-jet-proof (IP65)
- Note) VQ2000 only
- Manual override**
- Nil Non-locking push type (Tool required)
  - B Locking type (Tool required)
  - C Locking type (Manual)
  - D Slide locking type (Manual)

- Light/Surge voltage suppressor**
- Nil Yes
  - E (Note) None (Non-polar)

Note) A combination of "Function [N] (Negative common)" and [E] is unavailable.  
Since [E] has no polarity, it can also be used as a negative common. Selection of "Function [N]" is not required.

**Coil voltage**

	CE-compliant
1 100 VAC (50/60 Hz)	—
2 200 VAC (50/60 Hz)	—
3 110 VAC (50/60 Hz)	—
4 220 VAC (50/60 Hz)	—
5 24 VDC	●
6 12 VDC	●

**How to Order Manifold Assembly**

Specify the part numbers for valves and options together beneath the manifold base part number.

**<Example>**  
Lead wire kit with cable (3 m)  
VVQ11-06C6L2 ...1 set—Manifold base part no.  
\*VQ1100-51 ...2 sets—Valve part no. (Stations 1 to 2)  
\*VQ1200-51 ...2 sets—Valve part no. (Stations 3 to 4)  
\*VQ1300-51 ...1 set—Valve part no. (Station 5)  
\*VVQ1000-10A-1 ...1 set—Blanking plate part no. (Station 6)

Write sequentially from the 1st station on the D-side.  
When part nos. written collectively are complicated, specify them by means of the manifold specification sheet.

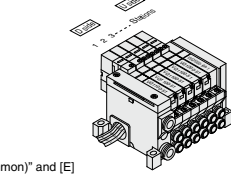

**⚠ Caution**  
Use the standard (DC) specification when continuously energizing for long periods of time.

SV
SYJ
SZ
VF
VP4
VQ 1/2
VQ 4/5
VQC 1/2
VQC 4/5
VQZ
SQ
VFS
VFR
VQ7

# VQ1000/2000 Series

## Kit (Lead wire)

### VV5Q11

<>: AC

The dashed lines indicate DIN rail mounting [-D] (with DIN rail mounting bracket).

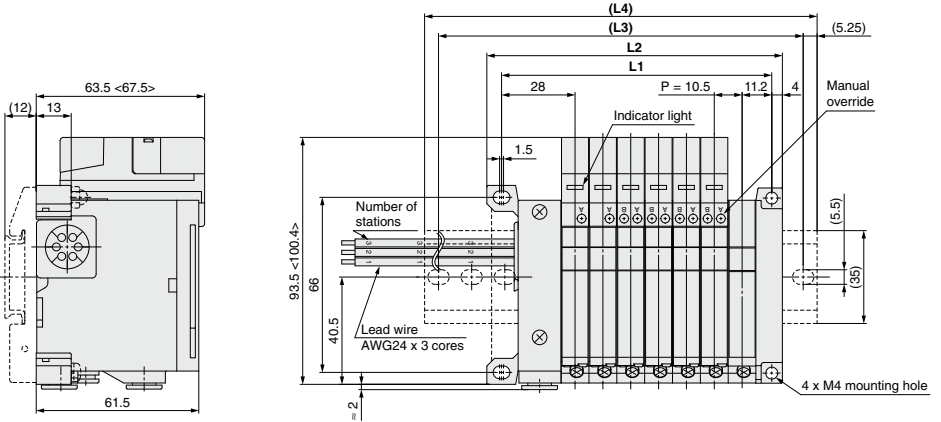

[D side] Stations -- 1 -- 2 -- 3 -- 4 -- 5 -- 6 -- 7 -- n [U side]

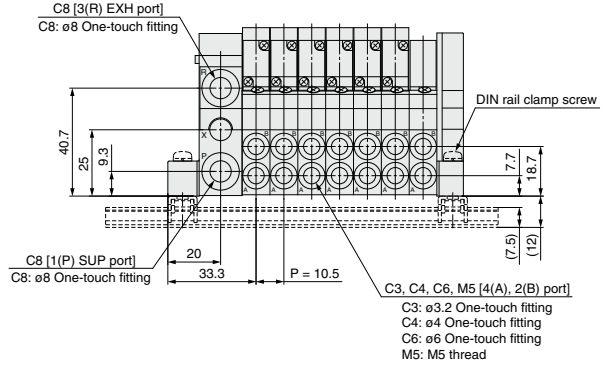

Formula L1 = 10.5n + 28.5, L2 = 10.5n + 38  
n: Station (Maximum 8 stations)

Dimensions	n	1	2	3	4	5	6	7	8
L1		39	49.5	60	70.5	81	91.5	102	112.5
L2		48.5	59	69.5	80	90.5	101	111.5	122
(L3)		75	87.5	87.5	100	112.5	125	137.5	150
(L4)		85.5	98	98	110.5	123	135.5	148	160.5

With ejector unit: Formula L1 = 10.5n + 28.5 + (Number of ejector units x 26.7)  
L2 = 10.5n + 38 + (Number of ejector units x 26.7)  
L4 is L2 plus about 30.



# VV5Q21

< >: AC

The dashed lines indicate DIN rail mounting [-D] (with DIN rail mounting bracket).

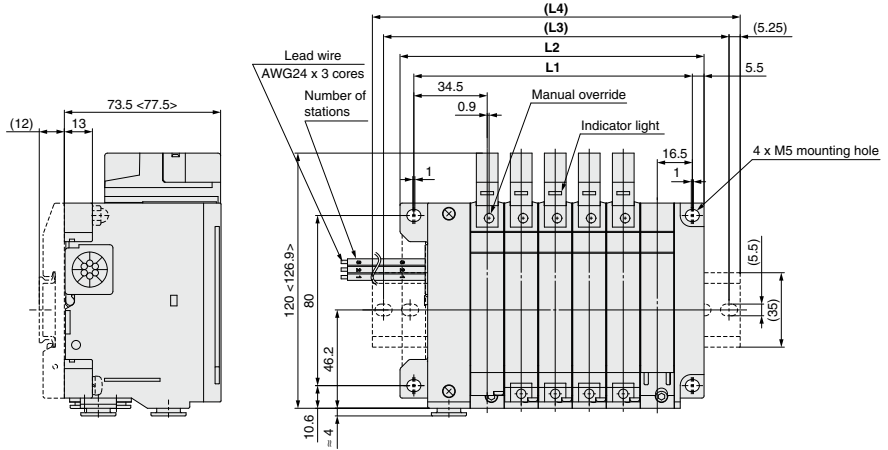

Dust-tight, Water-jet-proof

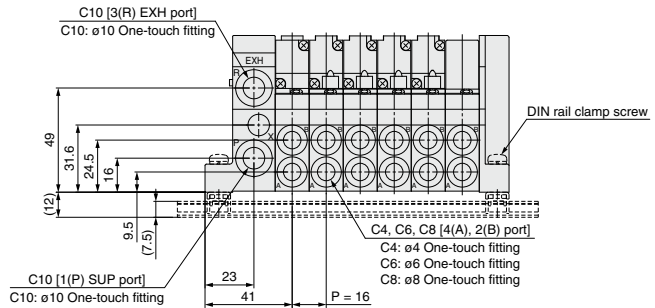
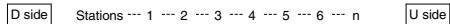

Formula  $L1 = 16n + 35$ ,  $L2 = 16n + 47$   
 n: Station (Maximum 8 stations)

**Dimensions**

n	1	2	3	4	5	6	7	8
<b>L1</b>	51	67	83	99	115	131	147	163
<b>L2</b>	63	79	95	111	127	143	159	175
<b>(L3)</b>	87.5	100	125	137.5	150	162.5	184.5	200
<b>(L4)</b>	98	110.5	135.5	148	160.5	173	198	210.5

- SV
- SYJ
- SZ
- VF
- VP4
- VQ 1/2**
- VQ 4/5
- VQC 1/2
- VQC 4/5
- VQZ
- SQ
- VFS
- VFR
- VQ7



# VQ1000/2000 Series

## Kit (Serial transmission) Base Mounted Plug-in Manifold: For EX510 Gateway-type Serial Transmission System

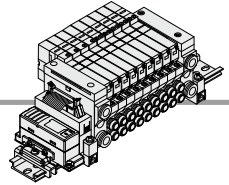

### How to Order Manifold

# VV5Q 1 1 - SB 08 - D -

#### Manifold series

1	VQ1000
2	VQ2000

#### SI unit specifications

NII	NPN output (+COM.)
N	PNP output (-COM.)

#### Valve stations

Symbol	Stations
01	1 station
⋮	⋮
08	8 stations

(Note) Max. 16 stations.  
(Special wiring specifications)

#### SI unit part no.

Symbol	SI unit specifications	SI unit part no.
NII	NPN output (+COM.)	EX510-S002A
N	PNP output (-COM.)	EX510-S102A

#### CE-compliant

NII	—
Q	CE-compliant

#### Option

<b>B</b> (Note 3)	With back pressure check valve
<b>D</b> (Note 1)	DIN rail mounting
<b>D</b> (Note 9)	DIN rail length specified (□: Stations 02 to 16)
<b>G1</b> (Note 4) (Note 8) (Note 10)	1 set of regulator unit
<b>G2</b> (Note 4) (Note 8) (Note 10)	2 sets of regulator unit
<b>G3</b> (Note 4) (Note 8) (Note 10)	3 sets of regulator unit
<b>J</b> (Note 5) (Note 8)	With ejector unit
<b>K</b> (Note 6)	Special wiring spec. (Except double wiring)
<b>N</b>	With name plate
<b>R</b> (Note 7)	with external pilot
<b>S</b>	Direct EXH outlet with built-in silencer

Note 1) Be sure to select "D" or "D□".

Note 2) When two or more symbols are specified, indicate them alphabetically.  
Example) -BRS

Note 3) Models with a suffix "-B" have check valves for prevention of back pressure at all manifold stations. When a back pressure check valve is desired, and is to be installed only in certain manifold stations, specify the mounting position by means of the manifold specification sheet.

Note 4) Specify the mounting position by means of the manifold specification sheet.  
Note 5) Refer to page 432 for details on with ejector unit. A combination of "J" and "N" is not available.

Note 6) Specify the wiring specifications by means of the manifold specification sheet.

Note 7) Indicate "R" for the valve with external pilot.

Note 8) VQ1000 only

Note 9) The number of stations that may be displayed is longer than the manifold number of stations.

Note 10) G1, G2, or G3 cannot be combined with N.

#### Cylinder port

Symbol	Port size	VQ1000	VQ2000
<b>C3</b>	With ø3.2 One-touch fitting	●	—
<b>C4</b>	With ø4 One-touch fitting	●	●
<b>C6</b>	With ø6 One-touch fitting	●	●
<b>C8</b>	With ø8 One-touch fitting	—	●
<b>M5</b>	M5 thread	●	—
<b>CM</b> (Note 1)	With mixed sizes and with port plug	●	●
<b>L3</b>	Top ported elbow with ø3.2 One-touch fitting	●	—
<b>L4</b>	Top ported elbow with ø4 One-touch fitting	●	●
<b>L6</b>	Top ported elbow with ø6 One-touch fitting	●	●
<b>L8</b>	Top ported elbow with ø8 One-touch fitting	—	●
<b>L5</b>	Top ported elbow M5 thread	●	—
<b>B3</b>	Bottom ported elbow with ø3.2 One-touch fitting	●	—
<b>B4</b>	Bottom ported elbow with ø4 One-touch fitting	●	●
<b>B6</b>	Bottom ported elbow with ø6 One-touch fitting	●	●
<b>B8</b>	Bottom ported elbow with ø8 One-touch fitting	—	●
<b>B5</b>	Bottom ported elbow M5 thread	●	—
<b>LM</b> (Note 1)	Elbow port, mixed sizes (Including upward, downward piping and mixed)	●	●
<b>N1</b>	ø1/8" with One-touch fitting	●	—
<b>N3</b>	ø5/32" with One-touch fitting	●	●
<b>N7</b>	ø1/4" with One-touch fitting	●	●
<b>N9</b>	ø5/16" with One-touch fitting	—	●
<b>M5T</b>	UNF10-32 thread	●	—
<b>NM</b> (Note 1)	With mixed sizes and with port plug	●	●
<b>LN1</b>	Top ported elbow with ø1/8" One-touch fitting	●	—
<b>LN3</b>	Top ported elbow with ø5/32" One-touch fitting	●	●
<b>LN7</b>	Top ported elbow with ø1/4" One-touch fitting	●	●
<b>LN9</b>	Top ported elbow with ø5/16" One-touch fitting	—	●
<b>L5T</b>	Top ported elbow UNF10-32 thread	●	—
<b>BN1</b>	Bottom ported elbow with ø1/8" One-touch fitting	●	—
<b>BN3</b>	Bottom ported elbow with ø5/32" One-touch fitting	●	●
<b>BN7</b>	Bottom ported elbow with ø1/4" One-touch fitting	●	●
<b>BN9</b>	Bottom ported elbow with ø5/16" One-touch fitting	—	●
<b>B5T</b>	Bottom ported elbow UNF10-32 thread	●	—
<b>LMN</b> (Note 1)	Elbow port, mixed sizes (Including upward, downward piping and mixed)	●	●
<b>MM</b> (Note 2)	Mixed size for different types of piping, option installed	●	●

Note 1) Indicate "Mixed sizes and with port plug" in the manifold specification sheet.

Note 2) When selecting the mixed size for different types of piping, dual flow fitting assembly, or double check block (direct mounting), enter "MM" and give instructions in the manifold specification sheet.

Refer to Best Pneumatics No. 1-1 and the Operation Manual for the details of EX510 Gateway-type Serial Transmission System. Please download the Operation Manual via our website, <http://www.smcworld.com>

### How to Order Manifold Assembly

#### Example

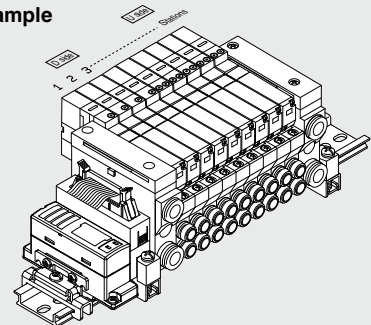

VV5Q11-SB08C6-D ... 1 set (SB kit, 8-station manifold part no.)  
 → VQ1100-51 ..... 4 sets (Single type part no.)  
 → VQ1200-51 ..... 3 sets (Double type part no.)  
 → VQ1300-51 ..... 1 set (3 position type part no.)

The asterisk denotes the symbol for assembly. Prefix it to the part nos. of the solenoid valve, etc.

Enter in order starting from the first station on the D-side.

Add the valve and option part numbers under the manifold base part number. In the case of complex arrangement, specify them by means of the manifold specification sheet.



How to Order Valves

VQ 1 1 0 0 - 5 1 -

Series

1	VQ1000
2	VQ2000

CE-compliant

Nil	—
Q	CE-compliant

Type of actuation

1	2-position single	
		(A)4 2(B) (R)1(S) 1 3(R)2 (P)
2	Metal 2-position double	
	Rubber 2-position double	
		(A)4 2(B) (R)1(S) 1 3(R)2 (P)
3	3-position closed center	
		(A)4 2(B) (R)1(S) 1 3(R)2 (P)
4	3-position exhaust center	
		(A)4 2(B) (R)1(S) 1 3(R)2 (P)
5	3-position pressure center	
		(A)4 2(B) (R)1(S) 1 3(R)2 (P)
A (Note)	4-position dual 3-port valve (A)	
		4(A) 2(B) 5(R)1 1(P) 3(R)2
B (Note)	4-position dual 3-port valve (B)	
		4(A) 2(B) 5(R)1 1(P) 3(R)2
C (Note)	4-position dual 3-port valve (C)	
		4(A) 2(B) 5(R)1 1(P) 3(R)2

Note) Rubber seal only

Manual override

Nil: Non-locking push type (Tool required)

B: Locking type (Tool required)

C: Locking type (Manual)

D: Slide locking type (Manual)

Rated voltage

5	24 VDC
---	--------

Function

Symbol	Specifications
Nil	Standard (0.4 W)
B	High-speed response type (0.95 W)
K (Note 1)	High-pressure type (1.0 MPa) [0.95 W]
N (Note 2)	Negative common
R (Note 2) (Note 4)	External pilot

Note 1) Metal seal only

Note 2) For external pilot and negative common specifications, refer to "Semi-standard" on pages 419 and 420.

Note 3) When two or more symbols are specified, indicate them alphabetically. Combination of [B] and [K] is not possible.

Note 4) Dual 3-port valve is not applicable.

Seal

0	Metal seal
1	Rubber seal

SV

SYJ

SZ

VF

VP4

VQ 1/2

VQ 4/5

VQC 1/2

VQC 4/5

VQZ

SQ

VFS

VFR

VQ7



# VQ1000/2000 Series

Kit (Serial transmission) Base Mounted Plug-in Manifold: For EX510 Gateway-type Serial Transmission System

## VV5Q11

Applicable connector: Flat ribbon cable connector (20P)  
(Complies with MIL-C-83503)

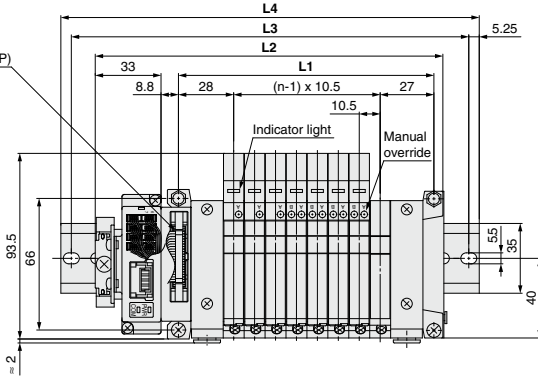
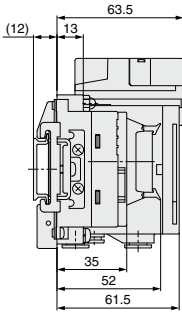

D side Stations · 1 · 2 · 3 · 4 · 5 · 6 · 7 · 8 · n U side

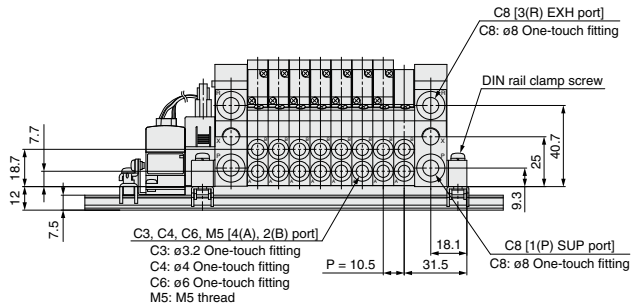

### Dimensions

Formula L1 = 10.5n + 44.5, L2 = 10.5n + 91 n: Station (Maximum 16 stations)

L	n	1	2	3	4	5	6	7	8	9	10	11	12	13	14	15	16
L1		55	65.5	76	86.5	97	107.5	118	128.5	139	149.5	160	170.5	181	191.5	202	212.5
L2		101.5	112	122.5	133	143.5	154	164.5	175	185.5	196	206.5	217	227.5	238	248.5	259
L3		125	137.5	150	162.5	175	187.5	200	212.5	225	237.5	250	262.5	275	287.5		
L4		135.5	148	160.5	173	185.5	198	210.5	223	235.5	248	260.5	273	285.5	298		

# VV5Q21

Applicable connector: Flat ribbon cable connector (20P)  
(Complies with MIL-C-83503)

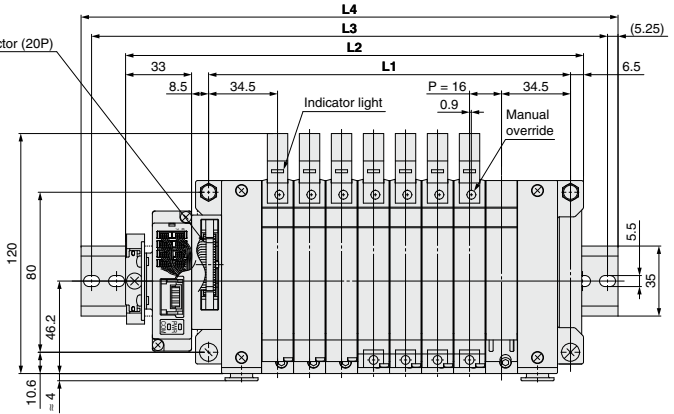
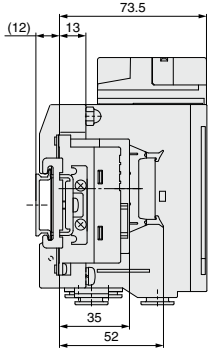

[D side] Stations -- 1 --- 2 --- 3 --- 4 --- 5 --- 6 --- 7 --- 8 --- n [U side]

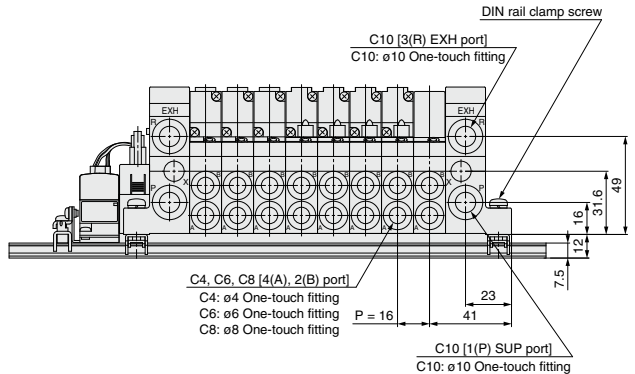

## Dimensions

Formula  $L1 = 16n + 53$ ,  $L2 = 16n + 101$  n: Station (Maximum 16 stations)

L \ n	1	2	3	4	5	6	7	8	9	10	11	12	13	14	15	16
<b>L1</b>	69	85	101	117	133	149	165	181	197	213	229	245	261	277	293	309
<b>L2</b>	117	133	149	165	181	197	213	229	245	261	277	293	309	325	341	357
<b>L3</b>	137.5	162.5	175	187.5	212.5	225	237.5	250	275	287.5	300	312.5	337.5	350	362.5	387.5
<b>L4</b>	148	173	185.5	198	223	235.5	248	260.5	285.5	298	310.5	323	348	360.5	373	398

- SV
- SYJ
- SZ
- VF
- VP4
- VQ 1/2
- VQ 4/5
- VQC 1/2
- VQC 4/5
- VQZ
- SQ
- VFS
- VFR
- VQ7

# S VQ1000/2000 Series

## Kit (Serial transmission): For EX120/123/124 Integrated-type (For Output) Serial Transmission System

### IP65 compliant

- The serial transmission system reduces wiring work, while minimizing wiring and saving space.
- Enclosure: Dust-tight, Water-jet-proof (IP65) compatible (VQ2000 series)

### Manifold Specifications

Series	Piping direction	Piping specifications			Applicable stations
		Port size			
		1(P), 3(R)	4(A), 2(B)		
VQ1000	Side	C8	C3, C4, C6, M5		Max. 16 stations
VQ2000	Side	C10	C4, C6, C8		Max. 16 stations

\* Refer to "SI Unit Part No." when ordering the CE-compliant SI unit.  (Option)

### How to Order Manifold

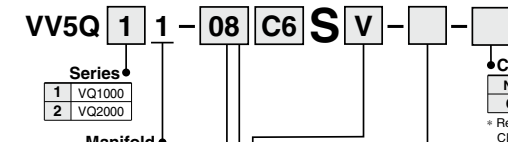

**Series**

1	VQ1000
2	VQ2000

**Manifold**

1	Plug-in unit
---	--------------

**Stations**

02	2 stations
...	...
16	16 stations

Note 1) Refer to page 419 for details.  
 Note 2) Max. 16 stations. (Specify a model with 9 to 16 stations by means of the manifold specification sheet.)

### SI unit specifications

Symbol	Protocol	Stations
0	Without SI unit	Max. 16 stations
H	NKE Corp.: Fieldbus H System (16 outputs)	
Q	DeviceNet™ System (16 outputs)	
R1	OMRON Corp.: CompoBus/S (16 outputs)	
R2	OMRON Corp.: CompoBus/S (8 outputs)	Max. 8 stations
V	CC-LINK (16 outputs)	Max. 16 stations
ZB	CompoNet™ (16 outputs) (Positive common)	
ZBN	CompoNet™ (16 outputs) (Negative common)	

Note) Communication connector (for the opposite side) is not provided, order it separately.

### Option

Symbol	Option	VQ1000	VQ2000
Nil	None	●	●
B	With back pressure check valve	●	●
D	DIN rail mounting	●	●
D	DIN rail mounting (□: Stations 02 to 24)	●	●
G1	1 set of regulator unit	●	—
G2	2 sets of regulator unit	●	—
G3	3 sets of regulator unit	●	—
J	With ejector unit	●	—
K	Special wiring specifications (Except double wiring)	●	●
N	With name plate	●	●
R	With external pilot	●	●
S	Direct EXH outlet with built-in silencer	●	●
W	Enclosure: Dust-tight, Water-jet-proof (IP65)	—	●

Note 1) When two or more symbols are specified, indicate them alphabetically.  
 Example) -BRS.  
 Note 2) Models with a suffix "-B" have check valves for prevention of back pressure at all manifold stations. When a back pressure check valve is desired, and is to be installed only in certain manifold stations, specify the mounting position by means of the manifold specification sheet.  
 Note 3) The number of stations that may be displayed is longer than the manifold number of stations.  
 Note 4) Specify the mounting position by means of the manifold specification sheet.  
 Note 5) Refer to page 432 for details on with vacuum ejector unit. A combination of "J" and "N" is not available.  
 Note 6) Specify the wiring specifications by means of the manifold specification sheet.  
 Note 7) Indicate "R" for the valve with external pilot.  
 Note 8) Refer to "Dimensions" on page 413 for SI unit and valve, in case of W (Dust-tight, Water-jet-proof).  
 Note 9) G1, G2, or G3 cannot be combined with N.  
 Note 10) When used in combination with the direct EXH outlet with built-in silencer type, keep the exhaust port from coming into direct contact with water or other liquids.

### Cylinder port

Symbol	Port size	VQ1000	VQ2000
C3	With ø3.2 One-touch fitting	●	—
C4	With ø4 One-touch fitting	●	●
C6	With ø6 One-touch fitting	●	●
C8	With ø8 One-touch fitting	—	●
M5	M5 thread	—	—
CM	Mixed sizes and with port plug	●	●
MM	Mixed size for different types of piping, option installed	●	●

Note 1) Insert "L" (Top ported) or "B" (Bottom ported) for elbow type.  
 Example) B6 (Bottom ported elbow with ø6 One-touch fitting)  
 Note 2) Indicate as "LM" (Including upward, downward piping and mixed) for models with elbow fittings and mixed cylinder port sizes.  
 Note 3) Indicate "Mixed sizes and with port plug" by means of the manifold specification sheet.

Note 4) When selecting the mixed size for different types of piping, dual flow fitting assembly, or double check block (direct mounting), enter "MM" and give instructions in the manifold specification sheet.  
 Note 5) Inch-size One-touch fittings are available. Refer to "Semi-standard" on page 420 for details.

### SI Unit Part No. (Without option W)

Symbol	Protocol	SI unit part no.	CE-compliant
H	NKE Corp.: Fieldbus H System (16 outputs)	Standard: EX120-SUH1	—
Q	DeviceNet™ (16 outputs)	Standard: EX120-SDN1 Dust-protected: No part no.	●
R1	OMRON Corp.: CompoBus/S (16 outputs)	Standard: EX120-SCS1	●
R2	OMRON Corp.: CompoBus/S (8 outputs)	Standard: EX120-SCS2	●
V	CC-LINK (16 outputs)	Standard: EX120-SMJ1	●
ZB	CompoNet™ (16 outputs) (Positive common)	Standard: EX120-SCM1 Dust-protected: No part no.	●
ZBN	CompoNet™ (16 outputs) (Negative common)	Standard: EX120-SCM3 Dust-protected: No part no.	●

### SI Unit Part No. (With option W)

Symbol	Protocol	SI unit part no.	CE-compliant
H	NKE Corp.: Fieldbus H System (16 outputs)	EX123D-SUH1	—
Q	DeviceNet™ System (16 outputs)	EX124D-SDN1	●
R1	OMRON Corp.: CompoBus/S (16 outputs)	EX124D-SCS1	●
R2	OMRON Corp.: CompoBus/S (8 outputs)	EX124D-SCS2	●
V	CC-LINK (16 outputs)	EX124D-SMJ1	●

Refer to Best Pneumatics No. 1-1 and the Operation Manual for the details of EX120/123/124 Integrated-type (for Output) Serial Transmission System. Please download the Operation Manual via our website, <http://www.smcworld.com>



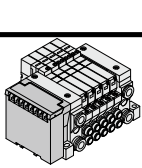

VV5Q11

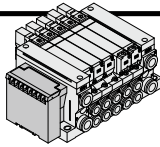

VV5Q21

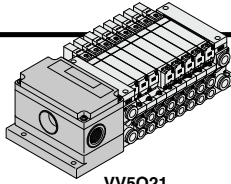

VV5Q21

Dust-tight, Water-jet-proof (-W)



**How to Order Valves**

VQ 1 1 0 0 [ ] - 5 [ ] [ ] 1 - [ ]

● **Series**

1	VQ1000
2	VQ2000

● **Type of actuation**

1	2-position single
2	2-position double
3	3-position closed center
4	3-position exhaust center
5	3-position pressure center
A	4-position dual port (N.C. +N.C.)
B	4-position dual port (N.O. +N.O.)
C	4-position dual port (N.C. +N.O.)

● **Seal**

0	Metal seal
1	Rubber seal

● **CE-compliant**

Nil	—
Q	CE-compliant

● **Enclosure**

Nil	Dust-protected
W Note)	Dust-tight, Water-jet-proof (IP65)

Note) VQ2000 only

● **Manual override**

Nil	Non-locking push type (Tool required)
B	Locking type (Tool required)
C	Locking type (Manual)
D	Slide locking type (Manual)

● **Coil voltage**

5	24 VDC; With indicator light/ surge voltage suppressor
---	--

● **Function**

Symbol	Specifications	DC
Nil	Standard	(0.4 W) ○
B	High-speed response type	(0.95 W) ○
K Note 1)	High-pressure type (1.0 MPa)	(0.95 W) ○
N Note 2)	Negative common	○
R Note 2) Note 4)	External pilot	○

Note 1) Metal seal only

Note 2) For external pilot and negative common specifications, refer to "Semi-standard" on pages 419 and 420.

Note 3) When two or more symbols are specified, indicate them alphabetically. Combination of [B] and [K] is not possible.

Note 4) Dual 3-port valve is not applicable.

**How to Order Manifold Assembly**

Specify the part numbers for valves and options together beneath the manifold base part number.

<Example>

- VV5Q11-08C6SV...1 set—Manifold base part no.
- VQ1100-51...2 sets—Valve part no. (Stations 1 to 2)
- VQ1200-51...4 sets—Valve part no. (Stations 3 to 6)
- VQ1300-51...1 set—Valve part no. (Station 7)
- VVQ1000-10A-1...1 set—Blanking plate part no. (Station 8)

Prefix the asterisk to the part nos. of the solenoid valve, etc.

Write sequentially from the 1st station on the D-side. When part nos. written collectively are complicated, specify them by means of the manifold specification sheet.

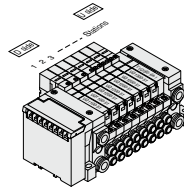

SV
SYJ
SZ
VF
VP4
VQ 1/2
VQ 4/5
VQC 1/2
VQC 4/5
VQZ
SQ
VFS
VFR
VQ7



# VQ1000/2000 Series

Kit (Serial transmission): For EX120 Integrated-type (For Output) Serial Transmission System

## VV5Q11

The dashed lines indicate DIN rail mounting [-D] (with DIN rail mounting bracket).

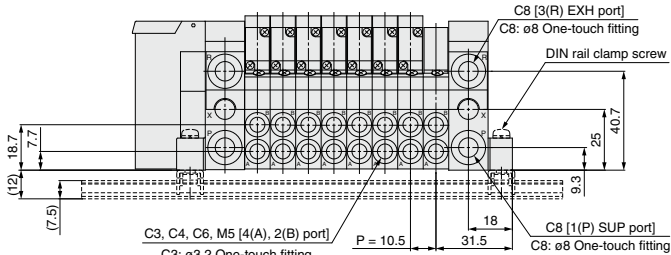
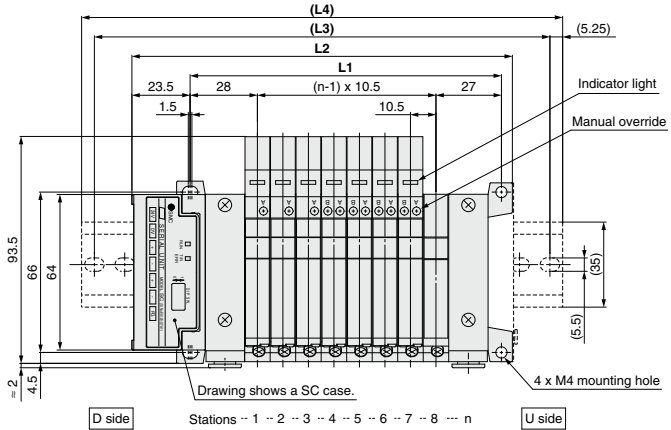
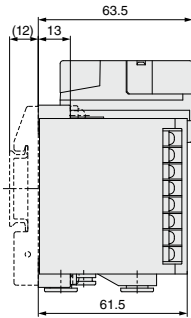

With ejector unit: Formula  
 $L1 = 10.5n + 28.7 + (\text{Number of ejector units} \times 26.7)$   
 $L2 = 10.5n + 56.3 + (\text{Number of ejector units} \times 26.7)$   
 $L4$  is  $L2$  plus about 30.

### Dimensions

Formula  $L1 = 10.5n + 44.5$ ,  $L2 = 10.5n + 72.5$  n: Station (Maximum 16 stations)

L	n	2	3	4	5	6	7	8	9	10	11	12	13	14	15	16
<b>L1</b>		65.5	76	86.5	97	107.5	118	128.5	139	149.5	160	170.5	181	191.5	202	212.5
<b>L2</b>		93.5	104	114.5	125	135.5	146	156.5	167	177.5	188	198.5	209	219.5	230	240.5
<b>(L3)</b>		125	125	137.5	150	162.5	175	187.5	187.5	200	212.5	225	237.5	250	250	262.5
<b>(L4)</b>		135.5	135.5	148	160.5	173	185.5	198	198	210.5	223	235.5	248	260.5	260.5	273



# VV5Q21

The dashed lines indicate DIN rail mounting [-D] (with DIN rail mounting bracket).  
 Note) In the case of EX124D-SMJ1, this dimension becomes 85.

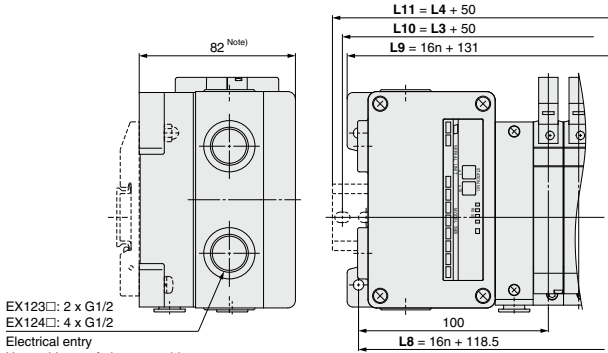

EX123□: 2 x G1/2  
 EX124□: 4 x G1/2  
 Electrical entry  
 Use a drip proof plug assembly (AXT100-B04A) on the unused conduit port (G1/2).

**Dust-tight, Water-jet-proof (IP65) SI unit**  
 (EX123/124 Integrated-type (output) serial transmission system)

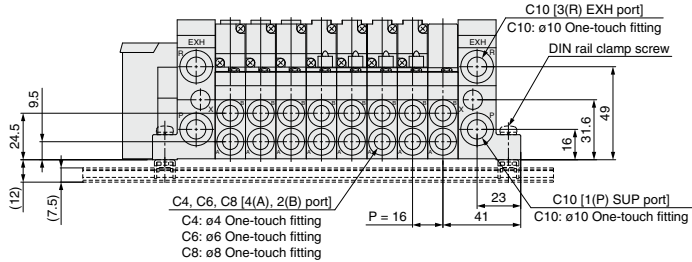
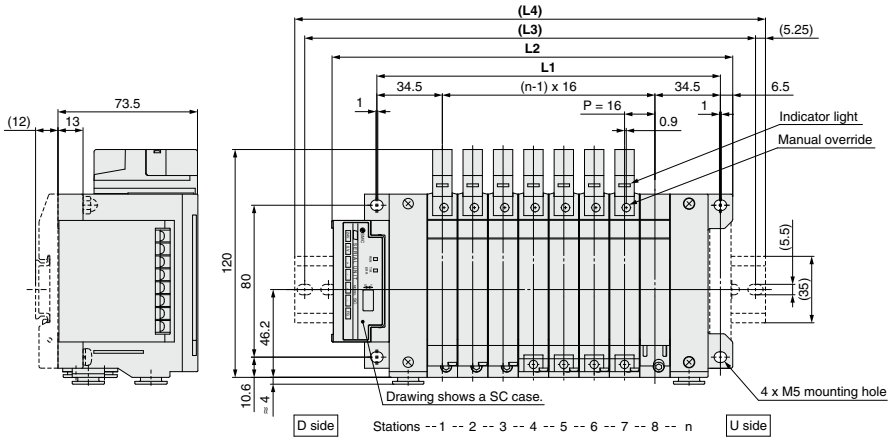

Dust-tight, Water-jet-proof SI unit:  $L8 = 16n + 118.5$ ,  $L9 = 16n + 131$   
 $L10 = L3 + 50$ ,  $L11 = L4 + 50$

Formula  $L1 = 16n + 53$ ,  $L2 = 16n + 83$  n: Station (Maximum 16 stations)

## Dimensions

L	n	2	3	4	5	6	7	8	9	10	11	12	13	14	15	16
<b>L1</b>		85	101	117	133	149	165	181	197	213	229	245	261	277	293	309
<b>L2</b>		115	131	147	163	179	195	211	227	243	259	275	291	307	323	339
<b>(L3)</b>		137.5	162.5	175	187.5	200	225	237.5	250	262.5	287.5	300	312.5	337.5	350	362.5
<b>(L4)</b>		148	173	185.5	198	210.5	235.5	248	260.5	273	298	310.5	323	348	360.5	373

- SV
- SYJ
- SZ
- VF
- VP4
- VQ 1/2
- VQ 4/5
- VQC 1/2
- VQC 4/5
- VQZ
- SQ
- VFS
- VFR
- VQ7

# M VQ2000 Series Kit (Circular connector)

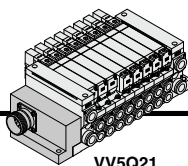

VQ2000 only

- MIL flat cable connector reduces installation labor for electrical connection.
- Manifold and connectors, both compliant with the IP65 rating (Dust-tight, Water-jet-proof), provide a high-degree of protection for the electrical parts. (When selecting option W)
- Maximum stations are 24.

## Manifold Specifications

Series	Piping specifications			Applicable stations
	Piping direction	Port size		
VQ2000	Side	1(P), 3(R)	4(A), 2(B)	Max. 24 stations

## Circular Connector (26 Pins)

## Cable Assembly ●

AXT100-MC26-015  
030

(Circular connector cable assembly included in a specific manifold model no.)  
Refer to "How to Order Manifold."

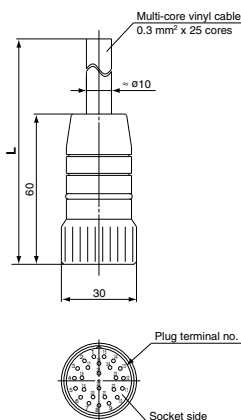

### Circular connector cable assembly

Cable length (L)	Assembly part no.	Note
1.5 m	AXT100-MC26-015	Cable 25-core x 24AWG
3 m	AXT100-MC26-030	
5 m	AXT100-MC26-050	

\* Cannot be used for transfer wiring.

### Electrical characteristics

Item	Property
Conductor resistance Ω/km, 20°C	65 or less
Voltage limit V, 1 min, AC	1000
Insulation resistance MΩ/km, 20°C or more	5

Note) The minimum bending radius of the circular connector cable is 20 mm.

### Circular connector cable assembly terminal no.

Terminal no.	Lead wire color	Dot marking
1	Black	None
2	Brown	None
3	Red	None
4	Orange	None
5	Yellow	None
6	Pink	None
7	Blue	None
8	Purple	White
9	Gray	Black
10	White	Black
11	White	Red
12	Yellow	Red
13	Orange	Red
14	Yellow	Black
15	Pink	Black
16	Blue	White
17	Purple	None
18	Gray	None
19	Orange	Black
20	Red	White
21	Brown	White
22	Pink	Red
23	Gray	Red
24	Black	White
25	White	None
26	White	None

Note) Lengths other than the above are also available. Please contact SMC for details.

## How to Order Manifold

Note) For CE-compliant models, DC-type only.

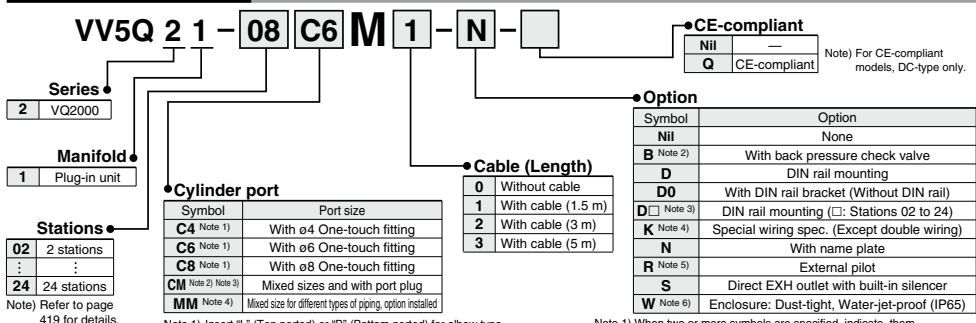

- Note 1) Insert "L" (Top ported) or "B" (Bottom ported) for elbow type. Example B6 (Bottom ported elbow with ø6 One-touch fitting)
- Note 2) Indicate "LM" (Including upward, downward piping and mixed) for models with elbow fittings and mixed cylinder port sizes.
- Note 3) Indicate "Mixed sizes and with port plug" by means of the manifold specification sheet.
- Note 4) When selecting the mixed size for different types of piping, dual flow fitting assembly, or double check block (direct mounting), enter "MM" and give instructions in the manifold specification sheet.
- Note 5) Inch-size One-touch fittings are available. Refer to "Semi-standard" on page 420 for details.

- Note 1) When two or more symbols are specified, indicate them alphabetically. Example) BKR
- Note 2) Models with a suffix "-B" have check valves for prevention of back pressure at all manifold stations. When a back pressure check valve is desired, and is to be installed only in certain manifold stations, specify the mounting position by means of the manifold specification sheet.
- Note 3) The number of stations that may be displayed is longer than the manifold number of stations.
- Note 4) Specify the wiring specifications by means of the manifold specification sheet.
- Note 5) Indicate "R" for the valve with external pilot.
- Note 6) When used in combination with the direct EXH outlet with built-in silencer type, keep the exhaust port from coming into direct contact with water or other liquids.

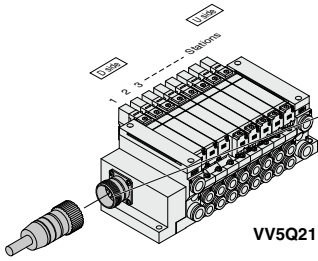

VV5Q21

The total number of stations is tabulated starting from station one on the D-side.

Electrical Wiring Specifications

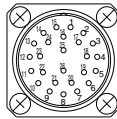

Circular connector cable assembly  
015  
AXT100-MC26-030 Wire color  
050

Terminal no.	Polarity	Lead wire color	Dot marking
Station 1 SOL A 1	(-)	(+) Black	None
Station 1 SOL B 2	(-)	(+) Brown	None
Station 2 SOL A 3	(-)	(+) Red	None
Station 2 SOL B 4	(-)	(+) Orange	None
Station 3 SOL A 5	(-)	(+) Yellow	None
Station 3 SOL B 6	(-)	(+) Pink	None
Station 4 SOL A 7	(-)	(+) Blue	None
Station 4 SOL B 8	(-)	(+) Purple	White
Station 5 SOL A 9	(-)	(+) Gray	Black
Station 5 SOL B 10	(-)	(+) White	Red
Station 6 SOL A 11	(-)	(+) White	Red
Station 6 SOL B 12	(-)	(+) Yellow	Red
Station 7 SOL A 13	(-)	(+) Orange	Red
Station 7 SOL B 14	(-)	(+) Yellow	Black
Station 8 SOL A 15	(-)	(+) Pink	Black
Station 8 SOL B 16	(-)	(+) Blue	White
Station 9 SOL A 17	(-)	(+) Purple	None
Station 9 SOL B 18	(-)	(+) Gray	None
Station 10 SOL A 19	(-)	(+) Orange	Black
Station 10 SOL B 20	(-)	(+) Red	White
Station 11 SOL A 21	(-)	(+) Brown	White
Station 11 SOL B 22	(-)	(+) Pink	Red
Station 12 SOL A 23	(-)	(+) Gray	Red
Station 12 SOL B 24	(-)	(+) Black	White
CCM 25	(+)	Note) (-) White	None
CCM 26	(+)	Note) (-) White	None

As the standard electrical wiring specifications, double wiring (connected to SOL A and SOL B) is adopted for the internal wiring of each station for 12 stations or less, regardless of valve and option types. Mixed single and double wiring is available as semi-standard. Refer to page 419 for details.

Note) When using the negative common specifications, use valves for negative common. (Refer to page 419.)  
Refer to "Semi-standard" on page 419 for details.

How to Order Valves

Note) For CE-compliant models, DC-type only.

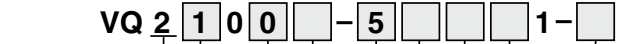

Series  
2 VQ2000

Type of actuation

1	2-position single
2	2-position double
3	3-position closed center
4	3-position exhaust center
5	3-position pressure center
A	4-position dual port (N.C. +N.C.)
B	4-position dual port (N.O. +N.O.)
C	4-position dual port (N.C. +N.O.)

Function

Symbol	Specifications	DC	AC
NII	Standard	(0.4 W) ○	Note 1) ○
B	High-speed response type	(0.95 W) ○	—
K Note 2)	High-pressure type (1.0 MPa)	(0.95 W) ○	—
N Note 3)	Negative common	○	—
R Note 3) Note 5)	External pilot	○	○

Note 1) For power consumption of AC type, refer to page 381.  
Note 2) Metal seal only  
Note 3) For external pilot and negative common specifications, refer to "Semi-standard" on pages 419 and 420.  
Note 4) When two or more symbols are specified, indicate them alphabetically. Combination of [B] and [K] is not possible.  
Note 5) Dual 3-port valve is not applicable.

Seal

0	Metal seal
1	Rubber seal

CE-compliant

NII	—
Q	CE-compliant

Note) For CE-compliant models, DC-type only.

Enclosure

NII	Dust-protected
W	Dust-tight, Water-jet-proof (IP65)

Manual override

NII	Non-locking push type (Tool required)
B	Locking type (Tool required)
C	Locking type (Manual)
D	Slide locking type (Manual)

How to Order Manifold Assembly

Specify the part numbers for valves and options together beneath the manifold base part number.

<Example>  
Circular connector kit with cable (3 m)  
VV5Q21-09C6M2-W · 1 set—Manifold base part no.  
· VQ2100-51 ······ 3 sets—Valve part no. (Stations 1 to 3)  
· VQ2200-51 ······ 3 sets—Valve part no. (Stations 4 to 6)  
· VQ2300-51 ······ 2 sets—Valve part no. (Stations 7 to 8)  
· VVQ2000-10A-1 ···· 1 set—Blanking plate part no. (Station 9)

Write sequentially from the 1st station on the D-side. When part nos. written collectively are complicated, specify them by means of the manifold specification sheet.

Prefix the asterisk to the part nos. of the solenoid valve, etc.

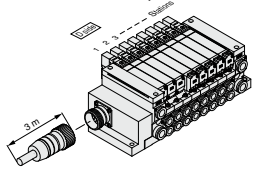

**Caution**  
Use the standard (DC) specification when continuously energizing for long periods of time.

Light/surge voltage suppressor

NII	Yes
E Note)	None (Non-polar)

Note) A combination of "Function [N] (Negative common)" and [E] is unavailable. Since [E] has no polarity, it can also be used as a negative common. Selection of "Function [N]" is not required.

Coil voltage

	CE-compliant
1	100 VAC (50/60 Hz) —
3	110 VAC (50/60 Hz) —
5	24 VDC ●
6	12 VDC ●

SV  
SYJ  
SZ  
VF  
VP4  
VQ 1/2  
VQ 4/5  
VQC 1/2  
VQC 4/5  
VQZ  
SQ  
VFS  
VFR  
VQ7

# M VQ2000 Series

## Kit (Circular connector)

### VV5Q21

< >: AC  
The dashed lines and dimensions in parentheses indicate DIN rail mounting [-D].

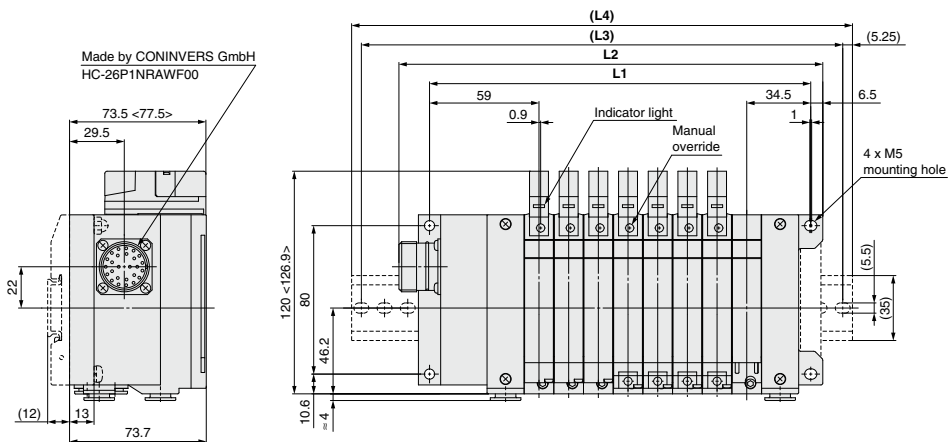

D side      Stations -- 1 -- 2 -- 3 -- 4 -- 5 -- 6 -- 7 -- 8 -- n      U side

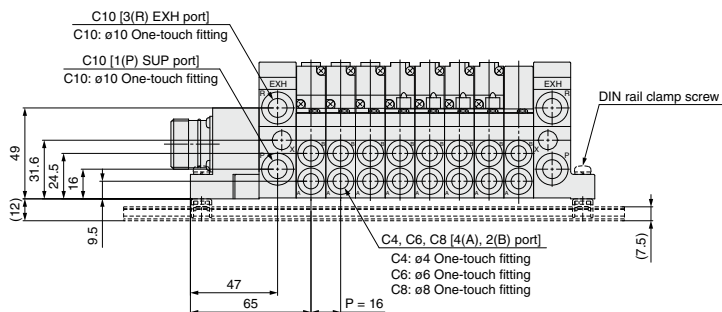

#### Dimensions

Formula  $L1 = 16n + 77.5$ ,  $L2 = 16n + 100.5$     n: Station (Maximum 12 stations)

L	n	2	3	4	5	6	7	8	9	10	11	12	13	14	15	16	17	18	19	20	21	22	23	24
<b>L1</b>		109.5	125.5	141.5	157.5	173.5	189.5	205.5	221.5	237.5	253.5	269.5	285.5	301.5	317.5	333.5	349.5	365.5	381.5	397.5	413.5	429.5	445.5	461.5
<b>L2</b>		132.5	148.5	164.5	180.5	196.5	212.5	228.5	244.5	260.5	276.5	292.5	308.5	324.5	340.5	356.5	372.5	388.5	404.5	420.5	436.5	452.5	468.5	484.5
<b>(L3)</b>		162.5	175	187.5	200	225	237.5	250	275	287.5	300	312.5	337.5	350	362.5	375	400	412.5	425	450	462.5	475	500	512.5
<b>(L4)</b>		173	185.5	198	210.5	235.5	248	260.5	285.5	298	310.5	323	348	360.5	373	385.5	410.5	423	435.5	460.5	473	485.5	510.5	523

# Sub-plate Single Unit

## VQ2000 Only

# VQ2000 Series

Note) For CE-compliant models, DC-type only.



### How to Order

SV
SYJ
SZ
VF
VP4
VQ 1/2
VQ 4/5
VQC 1/2
VQC 4/5
VQZ
SQ
VFS
VFR
VQ7

IP65 enclosure in standard specifications

Easy-to-use terminal block

In the case of **Valve** + **Sub-plate**

VQ2 1 0 0 - 5 W 1 - 02 - -

Entry is the same as standard products.

#### Enclosure

Nil	Dust-protected
W Note 1)	IP65 (Dust-tight, Water-jet-proof)

Note 1) Valves are IP65 specifications.  
Note 2) When the valve is a standard (dust-protected) specification, it is not compatible with 200 or 220 VAC.

CE-compliant

Nil	-
Q	CE-compliant

Note) For CE-compliant models, DC-type only.

#### Thread type

Nil	Rc
N	NPT
T	NPTF
F	G

In the case of **Sub-plate** alone

VQ2000 - PW - 02

Port size

02	1/4
----	-----

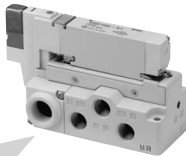
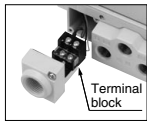

### Dimensions

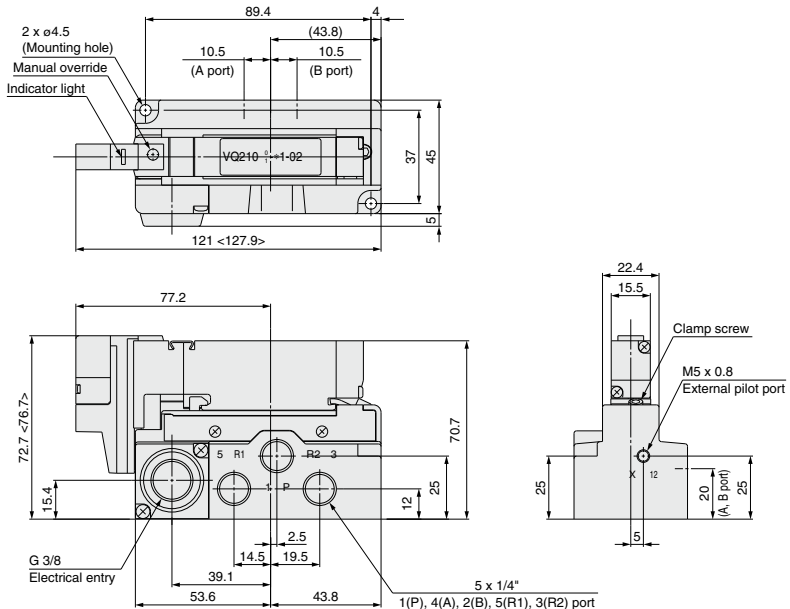

<> AC

Note) When using this valve for IP65, mount a seal connector to the electrical entry.



# VQ1000/2000 Series

## Semi-standard

### Different Number of Connector Pins

F and P kits with the following number of pins are available besides the standard number (F = 25P; P = 26P). Select the desired number of pins and cable length from the cable assembly list. Place an order for the cable assembly separately.

#### F kit (D-sub connector) 15 pins

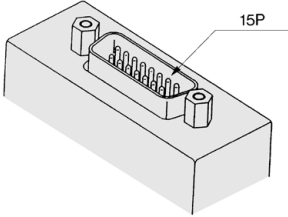

#### How to Order Manifold

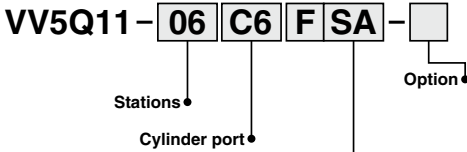

#### How to Order

D-sub connector, 15 pins  
Connector location—Side  
Without cable

#### Kit type/Electrical entry

Pins	Location	Top entry	Side entry
15P (Max. 7 stations)		F kit	UA
			F kit
			SA

\* In the same way as the 25-pin models (standard), the terminal no. 1 is for SOL.A at the 1st station, the terminal no. 9 for SOL.B at the 1st station, and the terminal no. 8 for COM.

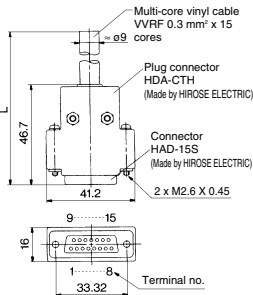

#### Wire Color Table by Terminal No. of D-sub Connector Cable Assembly

Terminal no.	Lead wire color	Dot marking
1	Black	None
2	Brown	None
3	Red	None
4	Orange	None
5	Yellow	None
6	Pink	None
7	Blue	None
8	Purple	White
9	Gray	Black
10	White	Black
11	White	Red
12	Yellow	Red
13	Orange	Red
14	Yellow	Black
15	Pink	Black

#### D-sub Connector Cable Assembly

Cable length (L)	Pins	15P
1.5 m		AXT100-DS15-1
3 m		AXT100-DS15-2
5 m		AXT100-DS15-3

\* For other commercial connectors, use a type conforming to MIL-C-24308.

#### P kit (Flat ribbon cable) 10/16/20 pins

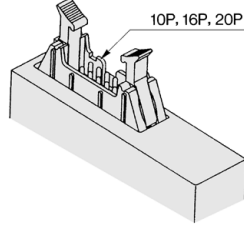

#### How to Order Manifold

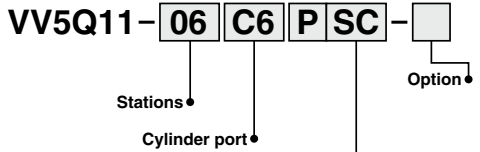

#### How to Order

Flat ribbon cable, 20 pins  
Connector location—Side  
Without cable

#### Kit type/Electrical entry

Pins	Location	Top entry	Side entry
10P (Max. 4 stations)	P kit	UA	SA
16P (Max. 7 stations)		UB	SB
20P (Max. 9 stations)		UC	SC

\* In the same way as the 26-pin models (standard), the terminal no. 1 is for SOL.A at the 1st station, the terminal no. 2 for SOL.B at the 1st station, and two pins from the max. terminal numbers are for COM.

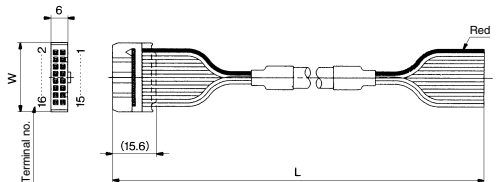

#### Flat Ribbon Cable Assembly

Cable length (L)	Pins	10P	16P	20P
1.5 m		AXT100-FC10-1	AXT100-FC16-1	AXT100-FC20-1
3 m		AXT100-FC10-2	AXT100-FC16-2	AXT100-FC20-2
5 m		AXT100-FC10-3	AXT100-FC16-3	AXT100-FC20-3
Connector width (W)		17.2	24.8	30

\* For other commercial connectors, use a type with strain relief conforming to MIL-C-83503.

### Special Wiring Specifications

In the internal wiring of F/P/J/G/T/S kit, double wiring (connected to SOL. A and SOL. B) is adopted for each station regardless of the valve and option types. Mixed single and double wiring is available as an option.

#### 1. How to Order

Indicate an option symbol "K", for the manifold no. and be sure to specify the mounting position and number of stations of the single and double wiring by means of the manifold specification sheet.

Example) **VV5Q11-08C6FU1-D K S**

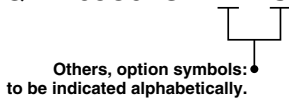

#### 2. Wiring specifications

With the A side solenoid of the 1st station as no.1 (meaning, to be connected to no.1 terminal), without making any terminals vacant.

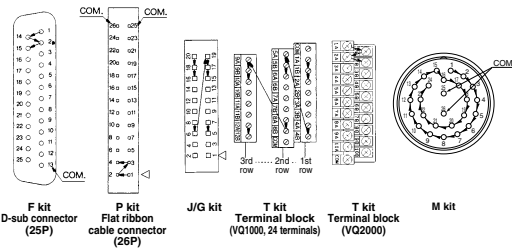

#### 3. Max. number of stations

The maximum number of stations depends upon the number of solenoids. Assuming one for a single and two for a double, determine the number of stations so that the total number is not more than the max. number given in the following table.

Kit	F kit (D-sub connector)		P kit (Flat ribbon cable)				J kit (Flat ribbon cable)	G kit (Flat ribbon cable with terminal block)
Type	F <sub>S</sub> <sup>U</sup> □ 25P	F <sub>S</sub> <sup>U</sup> A <sub>15</sub> P	P <sub>S</sub> <sup>U</sup> □ <sub>26</sub> P	P <sub>S</sub> <sup>U</sup> C <sub>20</sub> P	P <sub>S</sub> <sup>U</sup> B <sub>16</sub> P	P <sub>S</sub> <sup>U</sup> A <sub>10</sub> P	J <sub>S</sub> <sup>U</sup> □ <sub>20</sub> P	G □
Max. points	24	14	24	18	14	8	16	16

Kit	T kit (Terminal block box)		S kit (Serial transmission)	M kit (Circular connector)
Type	VQ1000		S □	M □
	2 rows of terminal blocks	3 rows of terminal blocks		
	16	24		
Max. points	20		16	24

### Negative Common Specifications

Specify the valve model no. as shown below for negative common specification.

The manifold no. shown below is for the T (VQ1000) and L (VQ1000/2000) kits. For other kits the standard manifold can be used. However, negative common is not compatible with S (except EX510 Gateway-type, EX240 integrated-type and EX120/121/122 integrated-type (CompoNet™)) and G kits.

#### How to Order Valves

**VQ1100 N - 51**

• Negative common specifications

#### How to Order Manifold

T kit (VQ1000):

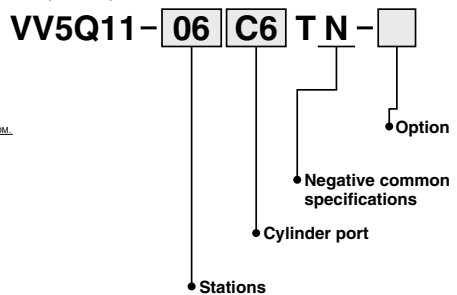

L kit (VQ1000/2000):

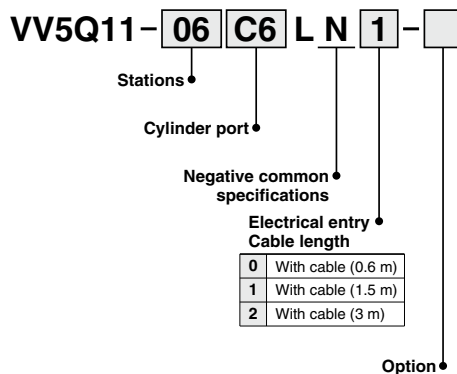

Electrical entry Cable length	
0	With cable (0.6 m)
1	With cable (1.5 m)
2	With cable (3 m)

SV
SYJ
SZ
VF
VP4
VQ 1/2
VQ 4/5
VQC 1/2
VQC 4/5
VQZ
SQ
VFS
VFR
VQ7

# VQ1000/2000 Series

## Semi-standard

### External Pilot Specifications

When the supply air pressure is lower than the required minimum operating pressure (0.1 to 0.2 MPa) for the solenoid valve (or when the valve is used for vacuum), specify an external pilot model. Order a manifold or valve by suffixing the external pilot specification, "R". The X-port of the manifold base is equipped with One-touch fittings for external pilot.  
 VQ1000: C4 (ø4 One-touch fitting)  
 VQ2000: C6 (ø6 One-touch fitting)

#### How to Order Manifold

**VV5Q11-08C6FU1-R S**

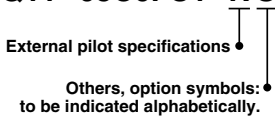

#### How to Order Valves

**VQ1100 R - 51**



Note 1) When two or more functions are specified, indicate them alphabetically.  
 Note 2) Since the pilot EXH of this valve is released from the R1 passage, it is not possible to vacuum from a part other than EXH pressure and SUP ports.

### Inch-size One-touch Fittings

The valve with inch-size One-touch fittings is shown below.

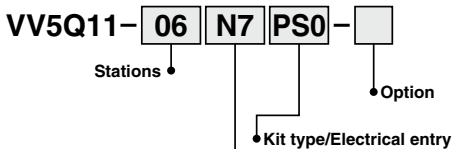

#### Cylinder port

Symbol	N1	N3	N7	N9	M5T	NM
Applicable tubing O.D. (Inch)	ø1/8"	ø5/32"	ø1/4"	ø5/16"	10-32UNF (MS thread)	Mixed
4(A), 2(B) port	<b>VQ1000</b>	●	●	—	●	●
	<b>VQ2000</b>	—	●	●	—	●

Note) When inch-size fittings are selected for the cylinder port, inch-size fittings are selected on 1(P), 3(R) port, too.

1(P), 3(R) port size  
 VQ1000 ..... ø5/16" (N9)  
 VQ2000 ..... ø3/8" (N11)

### DIN Rail Mounting

Each manifold can be mounted on a DIN rail. Order it by indicating a DIN rail mounting option symbol, "-D". In this case, a DIN rail which is approx. 30 mm longer than the manifold with the specified number of stations is attached.

- When DIN rail is unnecessary (DIN rail mounting brackets only are attached.)  
 Indicate the option symbol, -D0, for the manifold part number.

#### Example)

**VV5Q11-08C6FU1-D0S**

Others, option symbols: to be indicated alphabetically.

- When using DIN rail longer than the manifold with specified number of stations  
 Clearly indicate the necessary number of stations next to the option symbol "D" for the manifold part number.

#### Example)

**VV5Q11-08C6FU1-D09S**

DIN rail for 9 stations  
 Others, option symbols: to be indicated alphabetically.

\*The number of stations that may be displayed is longer than the manifold number of stations.

- When changing to a DIN rail mounting.  
 Order brackets for mounting a DIN rail. (Refer to "Manifold Optional Parts" on pages 430 and 436.)

No. VVQ1000-57A (For VQ1000)  
 VVQ2000-57A (For VQ2000)  
 2 pcs. per one set.

- When ordering DIN rail only  
 DIN rail no.: AXT100-DR-□

\* As for □, specify the number from the DIN rail table. Refer to the dimensions of each kit for L dimension.

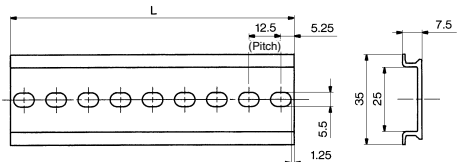

#### L Dimension

$$L = 12.5 \times n + 10.5$$

No.	1	2	3	4	5	6	7	8	9	10
L dimension	23	35.5	48	60.5	73	85.5	98	110.5	123	135.5
No.	11	12	13	14	15	16	17	18	19	20
L dimension	148	160.5	173	185.5	198	210.5	223	235.5	248	260.5
No.	21	22	23	24	25	26	27	28	29	30
L dimension	273	285.5	298	310.5	323	335.5	348	360.5	373	385.5
No.	31	32	33	34	35	36	37	38	39	40
L dimension	398	410.5	423	435.5	448	460.5	473	485.5	498	510.5



**SV**

**SYJ**

**SZ**

**VF**

**VP4**

**VQ**  
**1/2**

**VQ**  
**4/5**

**VQC**  
**1/2**

**VQC**  
**4/5**

**VQZ**

**SQ**

**VFS**

**VFR**

**VQ7**

# VQ1000/2000 Series Construction

## VQ1000 Plug-in Unit: Main Parts/Replacement Parts

### Metal seal

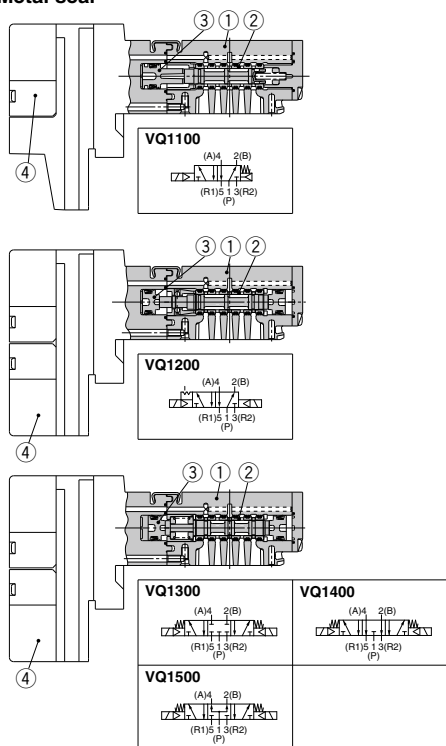

### Rubber seal

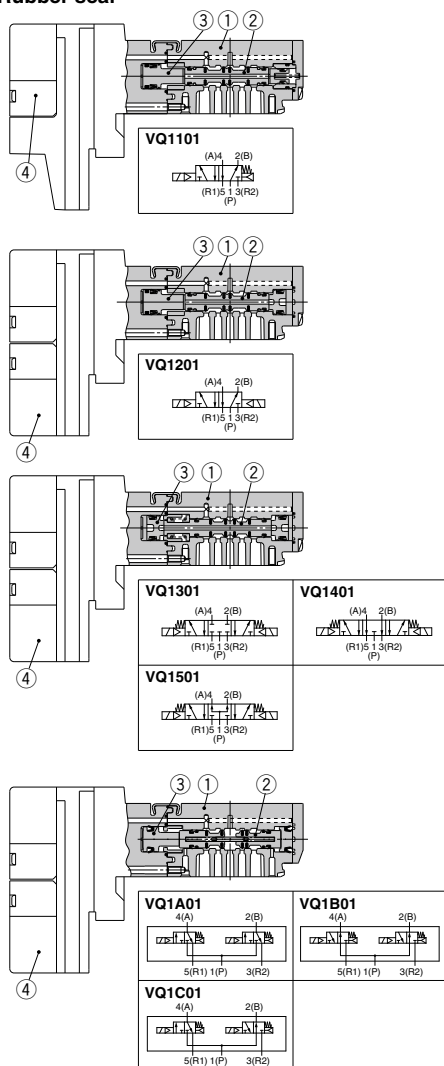

### Component Parts

No.	Description	Material	Note
1	Body	Zinc die-casted	
2	Spool/Sleeve	Stainless steel	
3	Piston	Resin	
4	Pilot valve assembly	—	

Note) Refer to page 425 for "How to Order Pilot Valve Assembly".

### Component Parts

No.	Description	Material	Note
1	Body	Zinc die-casted	
2	Spool valve	Aluminum, HNBR	
3	Piston	Resin	
4	Pilot valve assembly	—	

Note) Refer to page 425 for "How to Order Pilot Valve Assembly".

**VQ2000 Plug-in Unit: Main Parts/Replacement Parts**

**Metal seal**

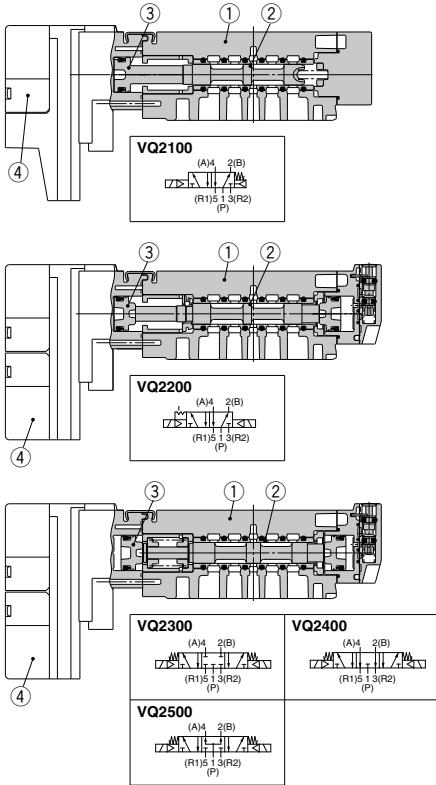

**Rubber seal**

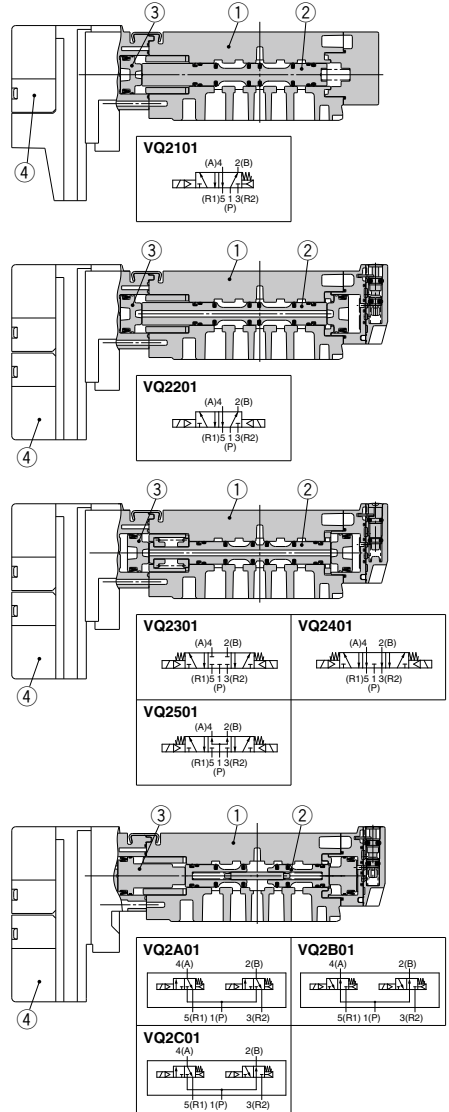

**Component Parts**

No.	Description	Material	Note
1	Body	Zinc die-casted	
2	Spool/Sleeve	Stainless steel	
3	Piston	Resin	
4	Pilot valve assembly	—	

Note) Refer to page 425 for "How to Order Pilot Valve Assembly".

**Component Parts**

No.	Description	Material	Note
1	Body	Zinc die-casted	
2	Spool valve	Aluminum, HNBR	
3	Piston	Resin	
4	Pilot valve assembly	—	

Note) Refer to page 425 for "How to Order Pilot Valve Assembly".

SV
SYJ
SZ
VF
VP4
<b>VQ 1/2</b>
VQ 4/5
VQC 1/2
VQC 4/5
VQZ
SQ
VFS
VFR
<b>VQ7</b>

# Exploded View of Manifold

## VQ1000 Plug-in Unit: Exploded View

(F/P/L/S kit)

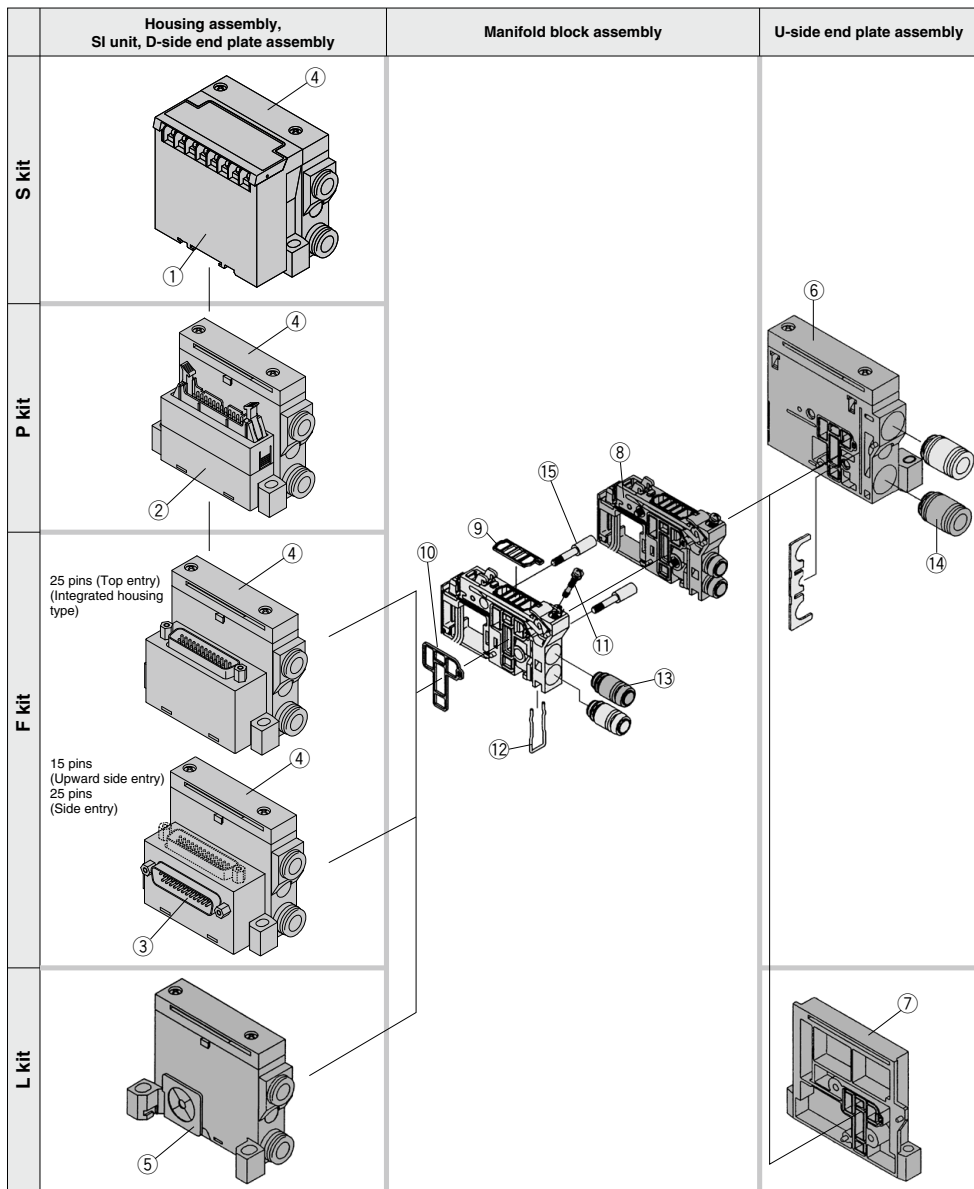

# Exploded View of Manifold

## <Housing Assembly and SI Unit>

### Housing assembly and SI unit no.

No.	Manifold	Part no.	Description
①	(SH kit)	<b>EX120-SUH1</b>	NKE Corp.: Fieldbus H System (16 outputs)
	(SQ kit)	<b>EX120-SDN1</b>	DeviceNet™
	(SR1 kit)	<b>EX120-SCS1</b>	OMRON Corp.: CompoBus/S (16 outputs)
	(SR2 kit)	<b>EX120-SCS2</b>	OMRON Corp.: CompoBus/S (8 outputs)
②	(SV kit)	<b>EX120-SMJ1</b>	CC-LINK
	P $\frac{3}{4}$ kit	<b>AXT100-1-P<math>\frac{3}{4}</math></b> <input type="checkbox"/> Note)	Flat ribbon cable housing assembly <input type="checkbox"/> = Number of pins: 26/20/16/10
③	J $\frac{3}{4}$ kit	<b>AXT100-1-J<math>\frac{3}{4}</math></b> Note)	Flat ribbon cable housing assembly
	FU kit	<b>AXT100-1-FU15</b>	D-sub connector housing assembly (Top entry) Number of pins: 15
	FS kit	<b>AXT100-1-FS</b> <input type="checkbox"/>	D-sub connector housing assembly (Side entry) <input type="checkbox"/> Number of pins: 25/15

Note) Top entry connector for FU, PU, JU while side entry connector for FS, JS, PS.

## <D-Side End Plate Assembly>

### ④⑤ D-side end plate assembly no.

**VVQ1000-3A-1-**  -

#### Electrical entry ●

<b>FU25</b>	For F kit top entry 25 pins
<b>F</b>	For F kit
<b>P</b>	For J/P kit
<b>L</b>	For L kit
<b>S</b>	For S kit

#### ● Option

<b>Nil</b>	Common EXH
<b>R</b> Note 1)	External pilot
<b>S</b> Note 1)	Direct EXH outlet with built-in silencer

Note 1) When both options are specified, indicate as RS.  
 Note 2) The housing assembly and SI unit of F/P/J/S kit are not included. Separately place an order for ①, ②, ③.

## <Manifold Block Assembly>

### ⑧ Manifold block assembly no.

**VVQ1000-1A-**  -

#### Electrical entry ●

<b>F0</b>	Without lead wire
<b>F1</b>	F kit for 2 to 12 stations/Double wiring
<b>F2</b>	F kit for 13 to 24 stations/Double wiring
<b>F3</b>	F kit for 2 to 24 stations/Single wiring
<b>P1</b>	P/J/S kit for 2 to 12 stations/Double wiring
<b>P2</b>	P/J/S kit for 13 to 24 stations/Double wiring
<b>P3</b>	P/J/S kit for 2 to 24 stations/Single wiring
<b>L0</b> <input type="checkbox"/>	L0 kit: Stations (1 to 8)
<b>L1</b> <input type="checkbox"/>	L1 kit: Stations (1 to 8)
<b>L2</b> <input type="checkbox"/>	L2 kit: Stations (1 to 8)

Tie-rod (2 pcs.) and lead wire assembly for extensions are attached.

#### ● Port size

<b>C3</b>	With ø3.2 One-touch fitting
<b>C4</b>	With ø4 One-touch fitting
<b>C6</b>	With ø6 One-touch fitting
<b>M5</b>	M5 thread
<b>C0</b>	Without One-touch fitting (With clip)

## <Replacement Parts for Manifold Block>

### Replacement Parts

No.	Part no.	Description	Material	Quantity
⑨	<b>VVQ1000-80A-1</b>	Gasket	HNBR	12
⑩	<b>VVQ1000-80A-2</b>	Packing	HNBR	12
⑪	<b>VVQ1000-80A-3</b>	Clamp screw	Carbon steel	12
⑫	<b>VVQ1000-80A-4</b>	Clip	Stainless steel	12

Note) A set of parts containing 12 pcs. each is enclosed.

## <U-Side End Plate Assembly>

### ⑥ U-side end plate assembly no. (For F/P/J/S kit)

**VVQ1000-2A-1-**  -

#### ● Option

<b>Nil</b>	Common EXH
<b>R</b>	External pilot
<b>S</b>	Direct EXH outlet with built-in silencer

Note) The 13's fitting assembly is included.

### ⑦ U-side end plate assembly no. (For L kit)

**VVQ1000-2A-1-L**

## <Fitting Assembly>

### ⑬ Fitting assembly part no. (For cylinder port)

**VVQ1000-50A-**  -

#### ● Port size

<b>C3</b>	Applicable tubing ø3.2
<b>C4</b>	Applicable tubing ø4
<b>C6</b>	Applicable tubing ø6
<b>M5</b>	M5 thread

Note) Purchasing order is available in units of 10 pieces.

### ⑭ Fitting assembly part no. (For 1(P), 3(R) port)

**VVQ1000-51A-C8**

#### ● Applicable tubing ø8

Note) Purchasing order is available in units of 10 pieces.

### ⑮ Tie-rod assembly part no. (2 pcs./set)

**VVQ1000-TR-**

Note 1) Please order when eliminating manifold stations.  
 When adding stations, tie-rods are attached to the manifold block assembly. Therefore, it is not necessary to order.

Note 2) : Stations 02 to 24

Note 3) For S/P/J/L kit

## Pilot valve assembly

**V112**  -  **A**

#### ● Function

Symbol	Specifications	DC (0.4 W)	AC Note 1)
<b>Nil</b>	Standard	<input type="checkbox"/>	<input type="checkbox"/>
<b>B</b>	High-speed response type	<input type="checkbox"/>	—
<b>K</b>	High-pressure type (1.0 MPa)	<input type="checkbox"/>	—

#### ● Coil voltage

<b>1</b>	100 VAC (50/60 Hz)
<b>2</b>	200 VAC (50/60 Hz)
<b>3</b>	110 VAC (50/60 Hz)
<b>4</b>	220 VAC (50/60 Hz)
<b>5</b>	24 VDC
<b>6</b>	12 VDC

Note 1) Refer to page 381 for power consumption of AC type.

Note 2) Common to single solenoid and double solenoid

Note 3) The voltage (including light/surge voltage suppressor), positive common and negative common cannot be changed by changing the pilot valve assembly.

# Exploded View of Manifold

## VQ2000 Plug-in Unit: Exploded View

(F/P/L/G/S kit)

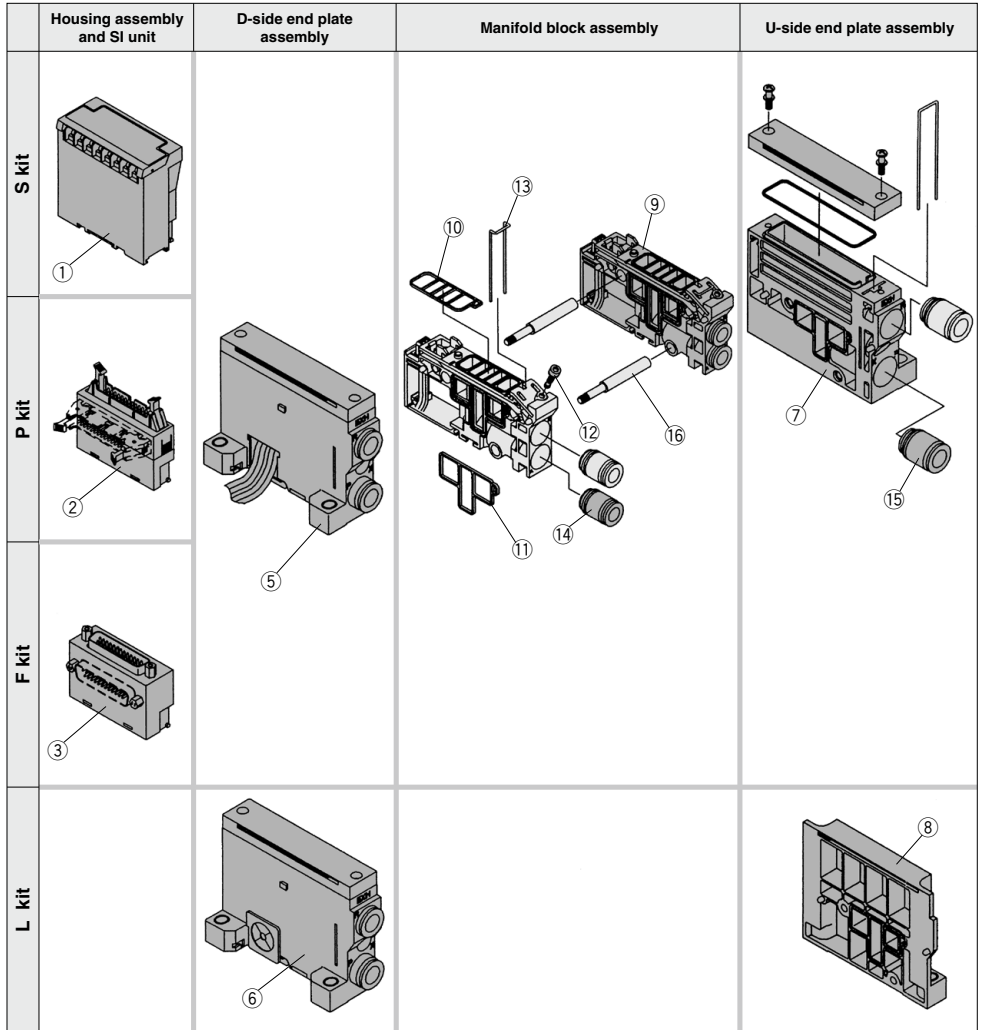

# Exploded View of Manifold

## <Housing Assembly and SI Unit> Housing assembly and SI unit no.

No.	Manifold	Part no.	Description
①	(SH kit)	<b>EX120-SUH1</b> [EX123D-SUH1] <small>Note 1)</small>	NKE Corp.: Fieldbus H System (16 outputs)
	(SQ kit)	<b>EX120-SDN1</b> [EX124D-SDN1] <small>Note 1)</small>	DeviceNet™
	(SR1 kit)	<b>EX120-SCS1</b> [EX124D-SCS1] <small>Note 1)</small>	OMRON Corp.: CompoBus/S (16 outputs)
	(SR2 kit)	<b>EX120-SCS2</b> [EX124D-SCS2] <small>Note 1)</small>	OMRON Corp.: CompoBus/S (8 outputs)
	(SV kit)	<b>EX120-SMJ1</b> [EX124D-SMJ1] <small>Note 1)</small>	CC-LINK
②	P <sub>S</sub> kit	<b>AXT100-1-P<sub>S</sub></b> <small>Note 2)</small>	Flat ribbon cable housing assembly □: Number of pins: 26/20/16/10
	J <sub>S</sub> kit	<b>AXT100-1-J<sub>S</sub></b> <small>Note 2)</small>	Flat ribbon cable housing assembly
③	F <sub>S</sub> kit	<b>AXT100-1-F<sub>S</sub></b> <small>Note 2)</small>	D-sub connector housing assembly □: Number of pins: 25/15
④	G kit	<b>AXT100-1-GU20</b>	Flat ribbon cable housing assembly with terminal block

Note 1) Dust-tight, Water-jet-proof (IP65)

Note 2) Top entry connector for FU, PU, JU while side entry connector for FS, PS, JS.

## <D-Side End Plate Assembly>

⑤⑥ D-side end plate assembly no.

**VVQ2000-3A-1-** □ □ □ □

### Electrical entry

<b>F</b>	For F kit
<b>P</b>	For G/J/P kit
<b>L</b>	For L kit
<b>S</b>	For S kit

### Enclosure

<b>Nil</b>	Dust-protected
<b>W</b> <small>Note 3)</small>	Dust-tight, Water-jet-proof (IP65)

Note) F/P/J/G kit are available with "Nil" only.

M kit is available with [W] only.  
S/L/T kit are selectable depending on the manifold type.

### Option

<b>Nil</b>	Common EXH
<b>R</b> <small>Note 1)</small>	External pilot
<b>S</b> <small>Note 1)</small>	Direct EXH outlet with built-in silencer

Note 1) When both options are specified, indicate as RS.

Note 2) The housing assembly and SI unit of F/P/J/G/S kit are not included.

Separately place an order for ①, ②, ③, ④.

Note 3) When used in combination with the direct EXH outlet with built-in silencer type, keep the exhaust port from coming into direct contact with water or other liquids.

## <Manifold Block Assembly>

⑨ Manifold block assembly no.

**VVQ2000-1A-** □ □ □ □

Tie-rod (2 pcs.) and lead wire assembly for extensions are attached.

### Electrical entry

<b>F0</b>	Without lead wire
<b>F1</b>	F kit for 2 to 12 stations/Double wiring
<b>F2</b>	F kit for 13 to 24 stations/Double wiring
<b>F3</b>	F kit for 2 to 24 stations/Single wiring
<b>P1</b>	P/J/G/S kit for 2 to 12 stations/Double wiring
<b>P2</b>	P/J/G/S kit for 13 to 24 stations/Double wiring
<b>P3</b>	P/J/G/S kit for 2 to 24 stations/Single wiring
<b>L0</b> □	L0 kit □: Stations (1 to 8)
<b>L1</b> □	L1 kit □: Stations (1 to 8)
<b>L2</b> □	L2 kit □: Stations (1 to 8)
<b>T1</b>	T kit for 2 to 20 stations/Double wiring
<b>T3</b>	T kit for 2 to 20 stations/Single wiring
<b>M1</b>	M kit for 2 to 12 stations/Double wiring
<b>M2</b>	M kit for 13 to 24 stations/Double wiring
<b>M3</b>	M kit for 2 to 24 stations/Single wiring

### Port size

<b>C4</b>	With ø4 One-touch fitting
<b>C6</b>	With ø6 One-touch fitting
<b>C8</b>	With ø8 One-touch fitting
<b>C0</b>	Without One-touch fitting (With clip)

### Enclosure

<b>Nil</b>	Dust-protected
<b>W</b>	Dust-tight, Water-jet-proof (IP65)

Note) F/P/J/G kit are available with "Nil" only.

S/L/T/M kit are selectable depending on the manifold type.

## <Replacement Parts for Manifold Block>

### Replacement Parts

No.	Part no.	Description	Material	Quantity
⑩	<b>VVQ2000-80A-1</b>	Gasket	HNBR	12
⑪	<b>VVQ2000-80A-2</b>	Seal	HNBR	12
⑫	<b>VVQ2000-80A-3</b>	Clamp screw	Carbon steel	12
⑬	<b>VVQ2000-80A-4</b>	Clip	Stainless steel	12

Note) A set of parts containing 12 pcs. each is enclosed.

## <U-Side End Plate Assembly>

⑦ U-side end plate assembly no. (For F/P/J/G/T/S/M kit)

**VVQ2000-2A-1-** □ □ □ □

### Option

<b>Nil</b>	Common EXH
<b>R</b>	External pilot
<b>S</b>	Direct EXH outlet with built-in silencer

### Enclosure

<b>Nil</b>	Dust-protected
<b>W</b> <small>Note 3)</small>	Dust-tight, Water-jet-proof (IP65)

Note) F/P/J/G kit are available with "Nil" only.

S/T/M kit are selectable depending on the manifold type.

Note 1) The ⑩'s fitting assembly is included.

Note 2) The housing assembly and SI unit of F/P/J/G/S kit are not included.

Separately place an order for ①, ②, ③, ④.

Note 3) When used in combination with the direct EXH outlet with built-in silencer type, keep the exhaust port from coming into direct contact with water or other liquids.

⑧ U-side end plate assembly no. (For L kit)

**VVQ2000-2A-1-L-** □ □ □ □

### Enclosure

<b>Nil</b>	Dust-protected
<b>W</b>	Dust-tight, Water-jet-proof (IP65)

Note) Select it depending on the manifold type.

## <Fitting Assembly>

⑭ Fitting assembly part no. (For cylinder port)

**VVQ1000-51A-** □ □ □ □

### Port size

<b>C4</b>	Applicable tubing ø4
<b>C6</b>	Applicable tubing ø6
<b>C8</b>	Applicable tubing ø8

Note) Purchasing order is available in units of 10 pieces.

⑮ Fitting assembly part no. (For 1(P), 3(R) port)

**VVQ2000-51A-C10**

Applicable tubing ø10

Note) Purchasing order is available in units of 10 pieces.

⑯ Tie-rod assembly part no. (2 pcs./set)

**VVQ2000-TR-** □ □ □ □

Note 1) Please order when eliminating manifold stations.

When adding stations, tie-rods are attached to the manifold block assembly. Therefore, it is not necessary to order.

Note 2) □: Stations 02 to 24

Note 3) For S/P/J/F/L kit

# VQ1000 Series

## VQ1000: Manifold Optional Parts

### Blanking plate assembly VVQ1000-10A-1



It is used by attaching on the manifold block for being prepared for removing a valve for maintenance reasons or planning to mount a spare valve, etc.

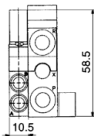
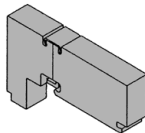

### Individual SUP spacer VVQ1000-P-1-C6

When the same manifold is to be used for different pressures, individual SUP spacers are used as SUP ports for different pressures. (One station space is occupied.) Block both sides of the station, for which the supply pressure from the individual SUP spacer is used, with SUP block plates. (Refer to the application example.)

\* Specify the spacer mounting position and SUP block plate position by means of the manifold specification sheet. The block plate is used in one or two places for one set. (Two SUP block plates for blocking SUP station are attached to the individual SUP spacer.)

\* As a standard, electric wiring is connected to the position of the manifold station where the individual SUP spacer is mounted.  
\* If wiring is not required for stations equipped with spacers, enter "X" in the special wiring specifications column in the manifold specification sheet.

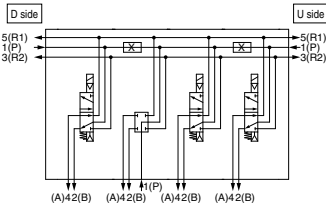
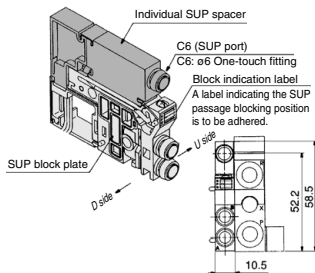

### Individual EXH spacer VVQ1000-R-1-C6

When valve exhaust affects other stations due to the circuit configuration, this spacer is used for individual valve exhaust. (One station space is occupied.) Block both sides of the individual valve EXH station. (Refer to the application example.)

\* Specify the mounting position, as well as the EXH block base or EXH block plate position by means of the manifold specification sheet. The block plate is used in one or two places for one set.  
\* An EXH block base assembly is used in the blocking position when ordering an EXH spacer incorporated with a manifold no. However, do not order an EXH block base assembly because it is attached to the spacer.

When separately ordering an individual EXH spacer, separately order an EXH block base assembly because it is not attached to the spacer.

\* As a standard, electric wiring is connected to the position of the manifold station where the individual EXH spacer is mounted.  
\* If wiring is not required for stations equipped with spacers, enter "X" in the special wiring specifications column in the manifold specification sheet.  
\* Do not install any back pressure check valve on the manifold station, on which the spacer is to be mounted. When installing the back pressure check valve on other manifold station, be sure to specify the manifold station position on the manifold specification sheet instead of ordering by specifying the manifold option symbol "B".

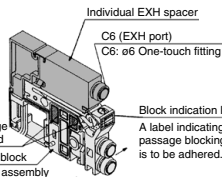

Description/Model		Stations						
Valve	Single	1	2	3	4	5	6	7
Option	Individual EXH spacer VVQ1000-R-1-C6							
	EXH blocking position: Specify 2 places.							

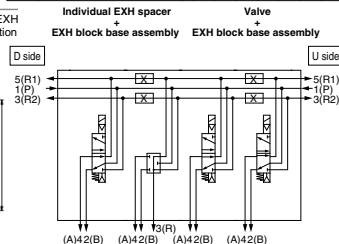

### SUP block plate VVQ1000-16A

When different pressures are supplied to a manifold, a SUP block plate is used to block the stations under different pressures.

\* Specify the mounting position by means of the manifold specification sheet.

#### <Block indication label>

Indication labels to confirm the blocking position are attached (Each for SUP passage and SUP/EXH passage blocking positions).

\* When ordering a block plate incorporated with a manifold, a block indication label is attached to the manifold.

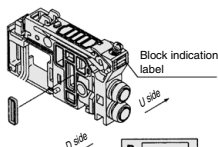

SUP passage blocked

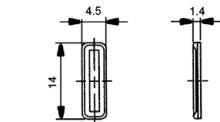

SUP/EXH passage blocked

### Blanking plate with connector VVQ1000-1C



Connector		Connector lead wire length (mm)	
Nil	Without connector	20	2000
1	With connector/2-wire	10	1000
2	With connector/4-wire	15	1500

Blanking plate with a connector for individually outputting electricity to drive a single valve or equipment that are not on the manifold base.

\* When "N" is suffixed to the end of the name plate, the plate will be different from a standard shape.  
Note) Electric current should be 1A or less (including the mounted valves).

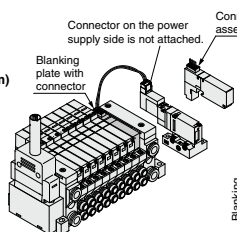

#### Connector assembly part no.

AXT661-43A-6

Lead wire length (mm)	Part No.
Nil	300
6	600
10	1000
20	2000
30	3000



**EXH block base assembly**  
**VVQ1000-19A-F** (C3/C4/C6/M5/N1/N3/N7)

Manifold block assembly  
 Electrical entry

F0	Without lead wire
F1	For F kit (2 to 12 stations)/Double wiring
F2	For F kit (13 to 24 stations)/Double wiring
F3	For F kit (2 to 24 stations)/Single wiring
P1	For P, G, T, S kit (2 to 12 stations)/Double wiring
P2	For P, G, T, S kit (13 to 24 stations)/Double wiring
P3	For P, G, T, S kit (2 to 24 stations)/Single wiring
L0*	L0 kit
L1*	L1 kit * 1 to 8 stations
L2*	L2 kit

The manifold block assembly is used between stations for which exhaust is desired to be divided when valve exhaust affects other stations due to the circuit configuration. The EXH passage on the D-side is blocked in the EXH block base assembly. It is also used in combination with an individual EXH spacer for individual exhaust.

**<Block indication label>**

Indication labels to confirm the blocking position are attached. (Each for EXH passage and SUP/EXH passage blocking positions)

\* When ordering a EXH block base assembly part with a manifold, a block indication label is attached to the manifold.

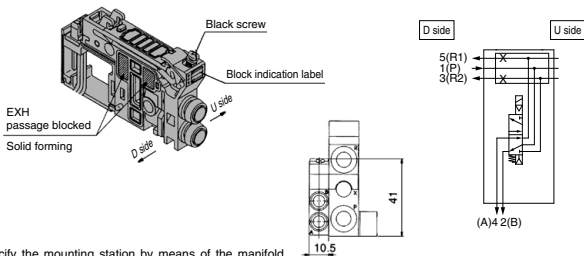

\* Specify the mounting station by means of the manifold specification sheet.

\* When ordering this option incorporated with a manifold, specify the EXH block base assembly part number with "\*" in front of it beneath the manifold part number.



EXH passage blocked



SUP/EXH passage blocked

**Back pressure check valve assembly [-B]**  
**VVQ1000-18A**

It prevents cylinder malfunction caused by other valve exhaust entry. Insert it into R (EXH) port on the manifold side of a valve which is affected. It is effective when a single-acting cylinder is used or an exhaust center type solenoid valve is used.

\* When ordering it being mounted on all manifold stations, suffix "-B" to the end of the manifold part number.

Note) When a back pressure check valve is desired, and it is to be installed only in certain manifold stations, clearly indicate the part number and specify the mounting station by means of the manifold specification sheet.

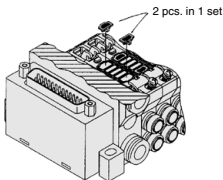

**(Precautions)**

1. The manifold installed type back pressure check valve assembly is assembly parts with a check valve structure. However, since slight air leakage against the back pressure is allowed due to its structure, adverse effects of the back pressure due to increase in exhaust resistance cannot be prevented if the manifold exhaust port and other exhaust ports are put together for piping or if the piping diameter is narrowed. As a result, this may cause the actuator and air operated equipment to malfunction. So, be careful not to restrict the exhaust air.

2. When a back pressure check valve is mounted, the effective area of the valve will decrease by about 20%.

**Name plate [-N]**  
**VVQ1000-N-NC** -N-Station (1 to Max. stations) (-X4)

N: Standard  
 NC: For mounting blanking plate with connector

-X4: For mounting slide locking type manual valve

It is a transparent resin plate for placing a label that indicates solenoid valve function, etc.

Insert it into the groove on the side of the end plate and bend it as shown in the figure.

\* When the blanking plate with connector is mounted, it automatically will be "VVQ1000-NC-n"

\* When the slide locking type manual valve is mounted, it automatically will be "VVQ1000-n-X4"

\* When ordering this option incorporated with a manifold, suffix "-N" to the end of the manifold part number.

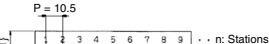
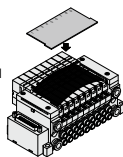

Note ( ) : VVQ1000-NC-n  
 Note { } : VVQ1000-N-n-X4

**Blanking plug (For One-touch fittings)**

**KQ2P-□**

It is inserted into an unused cylinder port and SUP/EXH ports.  
 Purchasing order is available in units of 10 pieces.

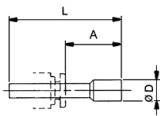

**Dimensions**

Applicable fitting size	Model	A	L	D	Applicable fitting size	Model	A	L	D
3.2	KQ2P-23	16	31.5	3.2	1/8"	KQ2P-01	16	31.5	5
4	KQ2P-04	16	32	6	5/32"	KQ2P-03	16	32	6
6	KQ2P-06	18	35	8	1/4"	KQ2P-07	18	35	8.5
8	KQ2P-08	20.5	39	10	5/16"	KQ2P-09	20.5	39	10

**Port plug**  
**VVQ000-58A**

The plug is used to block the cylinder port.

\* When ordering this option incorporated with a manifold, indicate "CM" for the port size of the manifold part number, as well as, the mounting station and cylinder port mounting positions 4(A) and 2(B) by means of the manifold specification sheet.

\* Gently screw an M3 screw in the port plug hole and pull it for removal.

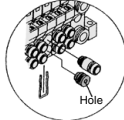

**Elbow fitting assembly**  
**VVQ1000-F-L**(C3/C4/C6/M5/N1/N3/N7)

It is used for piping that extends upward or downward from the manifold.

\* When ordering this option incorporated with a manifold, indicate "□" or "B□" for the manifold port size (when installed in all stations.)

When installing it in part of the manifold stations, specify the elbow fitting assembly part number and the mounting station by means of the manifold specification sheet.

\* When mounting elbow fitting assembly on the edge of manifold station and a silencer on EXH port, select a silencer, AN203-KM8.

A silencer (AN200-KM8) is interfered with fittings.

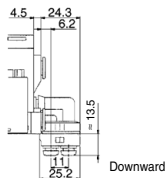
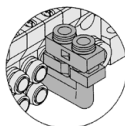

Downward

Upward

SV  
 SYJ  
 SZ  
 VF  
 VP4  
 VQ 1/2  
 VQ 4/5  
 VQC 1/2  
 VQC 4/5  
 VQZ  
 SQ  
 VFS  
 VFR  
 VQ7

# VQ1000 Series

## VQ1000: Manifold Optional Parts

### DIN rail mounting bracket [-D/-D0/-D□] VVQ1000-57A

It is used for mounting a manifold on a DIN rail.

- \* When ordering this option incorporated with a manifold, suffix "D" to the end of the manifold part number.

1 set of DIN rail mounting bracket is used for 1 manifold (2 DIN rail mounting brackets).

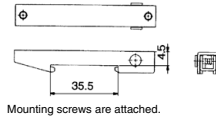
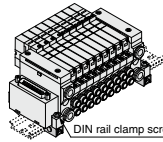

### Direct EXH outlet with built-in silencer [-S]

This is a type with an exhaust port at the top of the manifold end plate. The built-in silencer exhibits an excellent noise suppression effect. (Noise reduction: 30 dB)

- \* When ordering this option incorporated with a manifold, suffix "S" to the end of the manifold part number.

Note) A large quantity of drainage generated in the air source results in exhaust of air together with drainage.

- Refer to page 443 for maintenance.

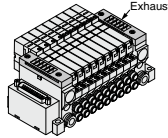

### Dual flow fitting assembly

#### VVQ1000-52A-C<sub>8</sub>-N<sub>9</sub>

This is a fitting to multiply the flow rate by combining the outputs of 2 valve stations. It is used for driving a large bore cylinder. This is a One-touch fitting for a port size of ø8 or ø5/16".

- \* The port size for the manifold part number is "MM".
- \* Clearly indicate the dual flow fitting assembly part number and specify the mounting station by means of the manifold specifications.
- \* In dual flow fitting assembly, a special clip which is combined in one-piece of 2 stations is attached as a holding clip.

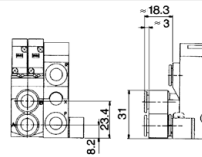
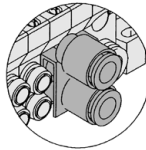

### Silencer (For EXH port)

This silencer is to be inserted into the EXH port (One-touch fittings) of the common exhaust type.

- \* When mounting elbow fitting assembly (VVQ1000-F-□) on the edge of manifold station, select a silencer, AN15-C08.

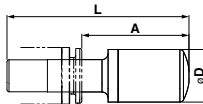

### Dimensions

Series	Applicable fitting size ød	Model	A	L	D	Effective area (mm <sup>2</sup> )	Noise reduction (dB)
VQ1000	8	AN15-C08	26.5	45	13	20	30

### Regulator unit

#### VVQ1000-AR-1

The regulator controls the SUP pressure in a manifold. Supply air from D-side SUP port is regulated. SUP port on U-side is plugged.

When a regulator unit is mounted, the SUP port on the U-side of the manifold will be plugged. A maximum of 3 units can be mounted on a manifold.

### Specifications

Maximum operating pressure (MPa)	0.8
Set pressure range (MPa)	0.05 to 0.7
Ambient and fluid temp. (°C)	5 to 50
Fluid	Air
Cracking pressure valve (MPa)	0.02
Structure	Relieving type

Pressure gauge  
G27-10-01  
Pressure control screw

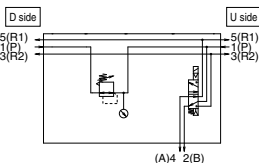
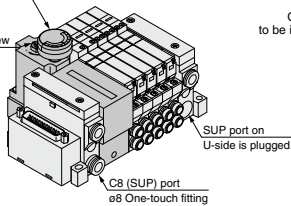

### • How to Order

Indicate an option symbol "G" for the manifold no. and be sure to specify the mounting position and number of stations by means of the manifold specification sheet. One unit is counted as one station and occupies a space for three stations, therefore, pay attention to the manifold size. The regulator valve unit, to which no wire is connected, valves can be mounted up to the standard max. number of stations of each kit.

### How to Order Manifold VV5Q11-14C6FUO-D G 2

Number of manifold stations  
Number of mounted valves ... 12 sets

Number of regulator units ... 2 sets

Others, option symbols: to be indicated alphabetically.

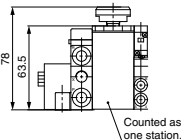
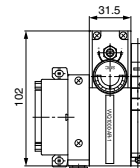

### Flow Rate Characteristics

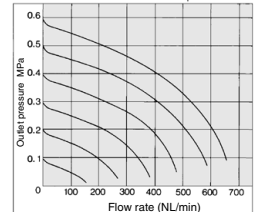

### Pressure Characteristics

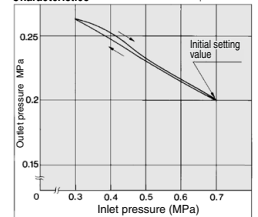

### ⚠ Caution

#### • Pressure setting

Check the inlet pressure and then turn the pressure control screw to set the outlet pressure. Turning the screw clockwise will increase the outlet pressure while turning it counterclockwise decrease the pressure. (Set the pressure by turning the screw in the increase direction.)

#### • Installation

Since some level of the actuator's operational frequency may lead to a sharp pressure change, pay attention to the pressure gauge durability.

**Double check block (Separated) for VQ1000**  
**VQ1000-FPG-□□-□□**

It is used on the outlet side piping to keep the cylinder in the intermediate position for a long time. Combining the double check block with a built-in pilot type double check valve and a 3-position exhaust center solenoid valve will enable the cylinder to stop in the middle or maintain its position for long periods of time.  
 The combination with a 2-position single/double solenoid valve will permit this block to be used for preventing the dropping at the cylinder stroke end when the SUP residual pressure is released.

**Specifications**

Max. operating pressure	0.8 MPa
Min. operating pressure	0.15 MPa
Ambient and fluid temp.	-5 to 50°C
Flow rate characteristics: C	0.60 dm <sup>3</sup> /(s·bar)
Max. operating frequency	180 c.p.m

Note) Based on JIS B 8375-1981 (Supply pressure: 0.5 MPa)

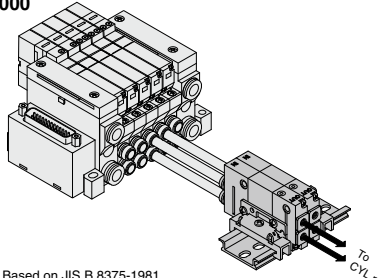

<Circuit diagram>

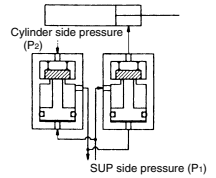

VVQ1000-FPG-02 1 set  
 \* VQ1000-FPG-C6M5-D 2 pcs.

**Dimensions**

**Single unit**

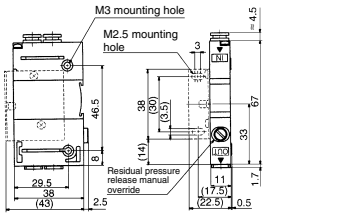
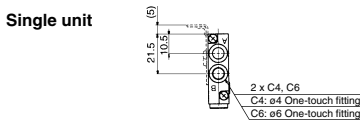

2 x C3, C4, C6, M5  
 C3: ø3.2 One-touch fitting  
 C4: ø4 One-touch fitting  
 C6: ø6 One-touch fitting  
 M5: M5 thread

**Manifold**

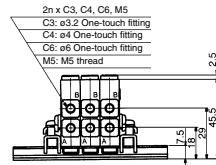
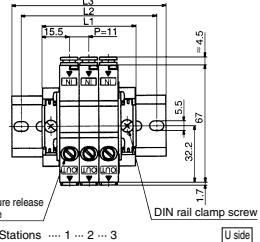
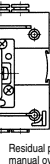
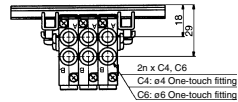

**Dimensions**

Formula L1 = 11n + 20 n: Station (Maximum 24)

	1	2	3	4	5	6	7	8	9	10	11	12
L1	31	42	53	64	75	86	97	108	119	130	141	152
L2	50	62.5	75	87.5	100	112.5	125	137.5	150	162.5	175	187.5
L3	60.5	73	85.5	98	110.5	123	135.5	148	160.5	173	185.5	198

	13	14	15	16	17	18	19	20	21	22	23	24
L1	163	174	185	196	207	218	229	240	251	262	273	284
L2	187.5	187.5	200	212.5	225	237.5	250	250	262.5	275	287.5	300
L3	198	198	210.5	223	235.5	248	260.5	260.5	273	285.5	298	310.5

**How to Order**

**Double check block**

VQ1000-FPG-**C4** **M5** - **F**

**IN side port size**

- M5 M5 thread
- C3 ø3.2 One-touch fitting
- C4 ø4 One-touch fitting
- C6 ø6 One-touch fitting
- N3 ø5/32" One-touch fitting
- N7 ø1/4" One-touch fitting

**OUT side port size**

- M5 M5 thread
- C3 ø3.2 One-touch fitting
- C4 ø4 One-touch fitting
- C6 ø6 One-touch fitting
- N3 ø5/32" One-touch fitting
- N7 ø1/4" One-touch fitting

**Option**

Nil	None
F	With bracket
D	DIN rail mounting (For manifold)
N	Name plate

Note) When two or more symbols are specified, indicate them alphabetically.  
 Example) -DN

**Manifold (DIN rail mounting)**

VVQ1000-FPG-**06**

When ordering a double check block, order the DIN rail mounting [-D].

**Stations**

01	1 station
⋮	⋮
16	16 stations

**<Ordering example>**

VVQ1000-FPG-06-6-station manifold

- \*VQ1000-FPG-C4M5-D, 3 sets
- \*VQ1000-FPG-C6M5-D, 3 sets

Double check block

**Bracket Assembly**

Part no.	Tightening torque
VQ1000-FPG-FB	0.22 to 0.25 N·m

<Example>

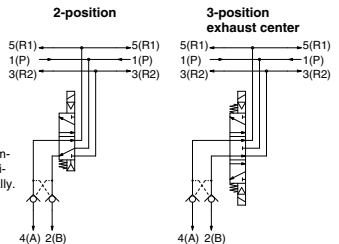

**Caution**

- Air leakage from the pipe between the valve and cylinder or from the fittings will prevent the cylinder from stopping for long periods of time. Check the leakage using neutral household detergent, such as dish washing soap. Also check the cylinder's tube gasket, piston packing and rod packing for air leakage.
- Since One-touch fittings allow slight air leakage, screw piping (with M5 thread) is recommended when stopping the cylinder in the middle for long periods of time.
- Combining double check block with 3-position closed center or pressure center solenoid valve will not work.
- M5 fitting assembly is attached, not incorporated into the double check block. After screwing in the M5 fittings, mount the assembly on the double check block. (Tightening torque: 0.8 to 1.2 N·m)
- If the exhaust of the double check block is restricted too much, the cylinder may not operate properly and may not stop immediately.
- Set the cylinder load so that the cylinder pressure will be within two times that of the supply pressure.

# VQ1000 Series

## VQ1000: Manifold Option/With Ejector Unit

An ejector unit can be mounted on the manifold base for a solenoid valve. Instead of mounting the valve and ejector unit separately, this option reduces piping, wiring and creates additional space savings.

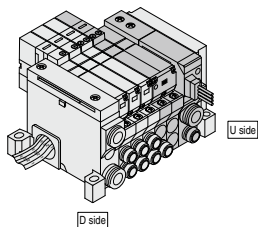

Note 1) SUP and EXH ports on the ejector unit manifold base are arranged on D-side alone. The end plate on the U-side is the same as that used in the L kit.

Note 2) Individual piping is provided for the supply and exhaust ports of the ejector unit.

Note 3) The manifold with an ejector unit is mounted from the U-side.

Note 4) One vacuum ejector unit corresponds to one station.

\* Specify the mounting station by means of the manifold specification sheet.

### Specifications

Ejector valve model	VVQ1000□-J□□□1-A	VVQ1000□-J□□□1-B
Nozzle diameter (mm)	0.7	1.0
Max. suction flow rate N (NL/min)	11	20
Max. vacuum pressure (mmHg)	-630	
Max. operating pressure (MPa)	0.7 (High-pressure type 0.8)	
Standard supply pressure (MPa)	0.5	
Operating temperature (°C)	5 to 50	

### Maximum Number of Ejector Units

(Max. number of ejector units is subject to the number of valve stations.)

Max. number of ejector units	Max. number of mounted valves		
	F, P, T kit	S, G, J kit	L kit
1	11 (20)	7 (14)	7
2	10 (16)	6 (12)	6
3	9 (12)	5 (10)	5
4	8 (8)	4 (8)	—
5	4 (4)	3 (4)	—

Note) The max. number of mounted valves applies to double wiring. Parenthesized numbers apply to single wiring. Please contact SMC for conditions other than the above or mixed wiring.

### Dimensions

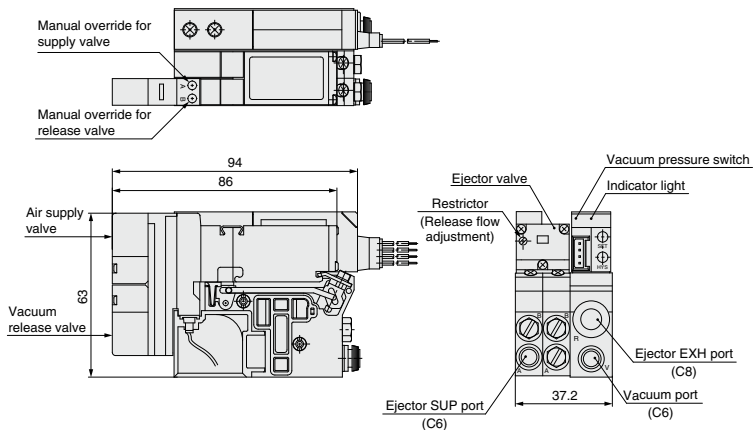

### How to Order

**VV5Q11-05C6FU0 - J P 1 S**

Vacuum switch	
Nil	None
P	With

Number of ejectors  
1 to 5

Others, option symbols:  
to be indicated alphabetically.

### Example)

**VV5Q11-05C6FU0-JP1** ..... 1 set—Manifold part no.

\*VQ1100-51 ..... 2 sets—Valve part no. (Stations 1 to 2)

\*VQ1200-51 ..... 2 sets—Valve part no. (Stations 3 to 4)

\*VVQ1000-J1-51-A ..... 1 set—Ejector valve part no.

\*ZSE1-00-15CL ..... 1 set—Vacuum switch part no.

Note 1) Count one ejector unit as one manifold station.

Note 2) The ejector unit is mounted next to the U-side end plate.

Note 3) The U-side end plate is used exclusively for ejector units. (Without P and R port)

Note 4) The dimension of manifold with an ejector unit is different from the standard dimension. See the formula for calculating the dimensions for each kit.

How to Order Ejector Valves

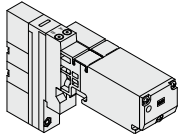

**VVQ1000** - **J** **1** - **5** **C** **1** - **A**

Function		DC	AC
Symbol	Specifications	(0.4 W)	(Note 1)
Nil	Standard	○	○
B	High-speed response type	(0.95 W)	—
K	High-pressure type (0.8 MPa)	(0.95 W)	—
N	Negative common	○	—

Note 1) For power consumption of AC type, refer to page 381.  
 Note 2) When two or more symbols are specified, indicate them alphabetically. Combination of [B] and [K] is not possible.

Coil voltage

1	100 VAC (50/60 Hz)
2	200 VAC (50/60 Hz)
3	110 VAC (50/60 Hz)
4	220 VAC (50/60 Hz)
5	24 VDC
6	12 VDC

Specifications

Symbol	Nozzle diameter	Vacuum release valve
A	0.7	With
B	1.0	With

Manual override

Nil	Non-locking push type
B	Locking type (Tool required)
C	Locking type (Manual)
D	Slide locking type (Manual)

Manifold

1	Plug-in unit
---	--------------

How to Order Vacuum Pressure Switches

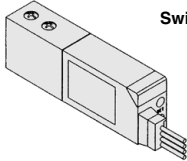

**ZSE1-00** - **15** **CL**

Switch spec./Voltage (Solid state: 12 to 24 VDC)

14	1 setting, Without analog output, 3 revolution adjustment
15	1 setting, Without analog output, 200° adjustment
16	2 setting, Without analog output, 3 revolution adjustment
17	2 setting, Without analog output, 200° adjustment
18	1 setting, With analog output, 3 revolution adjustment
19	1 setting, With analog output, 200° adjustment

Wiring specifications

Nil	Grommet type, Lead wire length 0.6 m
L	Grommet type, Lead wire length 3 m
C	Connector type, Lead wire length 0.6 m
CL	Connector type, Lead wire length 3 m
CN	Without connector (Note)

Note) When ordering the switch with 5 m lead wire length, order separately the switch without connector and the connector. (Refer to the below.) Besides, refer to the Vacuum Equipment (SMC website) for details.

How to Order Connectors

- Without lead wire (Connector 1 pc., Socket 4 pcs.) ..... ZS-20-A
- With lead wire ..... ZS-20-5A-50

Lead wire length (m)

Nil	0.6
30	3
50	5

Flow/Exhaust Characteristics of Ejector Unit

(The flow rate characteristics are for the supply pressure of 0.5 MPa.)

Nozzle Diameter ø0.7  
Exhaust Characteristics

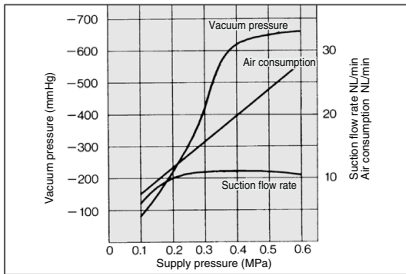

Flow Rate Characteristics

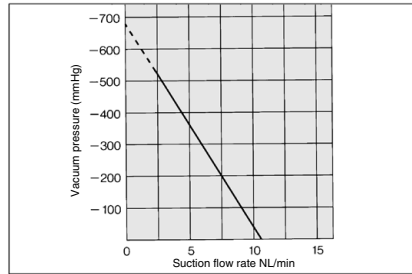

Nozzle diameter ø1.0  
Exhaust Characteristics

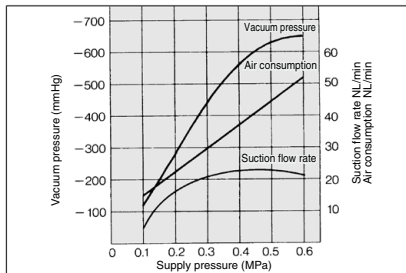

Flow Rate Characteristics

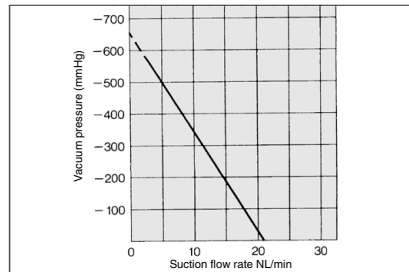

# VQ2000 Series

## VQ2000: Manifold Optional Parts

### Blanking plate assembly **Symbol** VVQ2000-10A-1

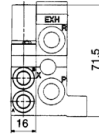
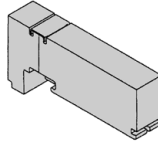

It is used by attaching on the manifold block for being prepared for removing a valve for maintenance reasons or planning to mount a spare valve, etc.

### Individual SUP spacer VVQ2000-P-1-C8-N9

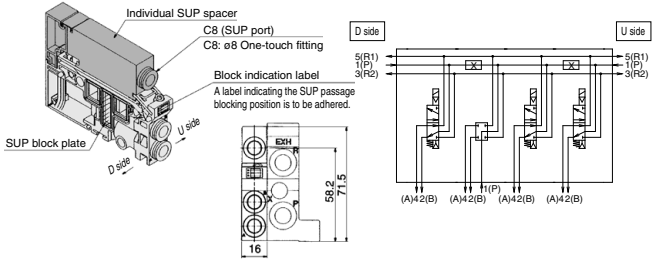

When the same manifold is to be used for different pressures, individual SUP spacers are used as SUP ports for different pressures. (One station space is occupied.) Block both sides of the station, for which the supply pressure from the individual SUP spacer is used, with SUP block plates. (Refer to the application example.)

- \* Specify the spacer mounting position and SUP block plate position by means of the manifold specification sheet. The block plate is used in one or two places for one set. (Two SUP block plates for blocking SUP station are attached to the individual SUP spacer.)
- \* As a standard, electric wiring is connected to the position of the manifold station where the individual SUP spacer is mounted.
- \* If wiring is not required for stations equipped with spacers, enter "X" in the special wiring specifications column in the manifold specification sheet.

### Individual EXH spacer VVQ2000-R-1-C8-N9

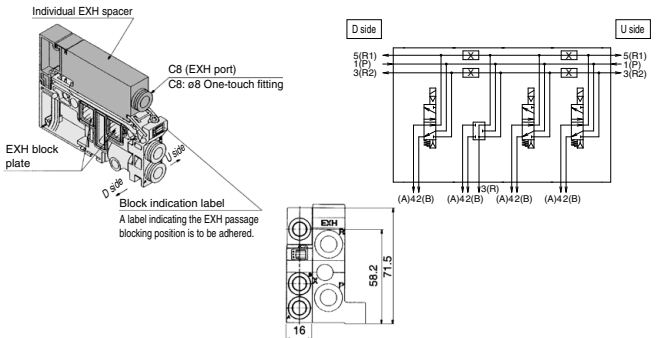

When valve exhaust affects other stations due to the circuit configuration, this spacer is used for individual valve exhaust. (One station space is occupied.) Block both sides of the individual valve EXH station. (Refer to the application example.)

- \* Specify the mounting position, as well as the EXH block base or EXH block plate position by means of the manifold specification sheet.
- The block plate is used in one or two places for one set. (Two EXH block plates for blocking EXH station are attached to the individual EXH spacer.)
- \* As a standard, electric wiring is connected to the position of the manifold station where the individual EXH spacer is mounted.
- \* If wiring is not required for stations equipped with spacers, enter "X" in the special wiring specifications column in the manifold specification sheet.
- \* Do not install any back pressure check valve on the manifold station, on which the spacer is to be mounted. When installing the back pressure check valve on other manifold station, be sure to specify the manifold station position on the manifold specification sheet instead of ordering by specifying the manifold option symbol "B".

### SUP block plate VVQ2000-16A

When different pressures are supplied to a manifold, a SUP block plate is used to block the stations under different pressures.

- \* Specify the mounting position by means of the manifold specification sheet.

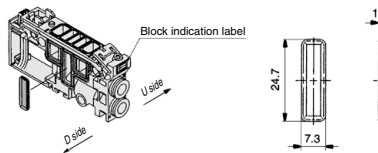

#### <Block indication label>

Indication labels to confirm the blocking position are attached. (Each for SUP passage and SUP/EXH passage blocking positions)



SUP passage blocked



SUP/EXH passage blocked

\* When ordering a block plate incorporated with a manifold, a block indication label is attached to the manifold.

### EXH block plate VVQ2000-19A

The EXH block plate is used between stations for which exhaust is desired to be divided when valve exhaust affects other stations configuration. It is also used in combination with an individual EXH spacer for individual exhaust.

- \* Specify the mounting position by means of the manifold specification sheet.

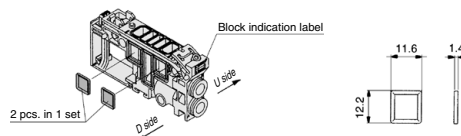

#### <Block indication label>

Indication labels to confirm the blocking position are attached. (Each for EXH passage and SUP/EXH passage blocking positions)



EXH passage blocked



SUP/EXH passage blocked

\* When ordering a block plate incorporated with a manifold, a block indication label is attached to the manifold.

**SUP stop valve spacer**  
**VVQ2000-24A-1**

A SUP stop valve spacer is mounted on a manifold block, making it possible to individually shut off supply air to each valve.  
 Enclosure: Dust-tight, Water-jet-proof (IP65) compliant

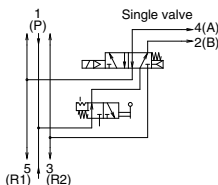
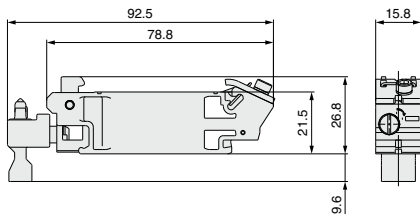
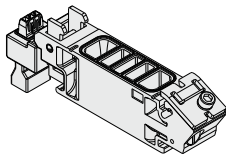

<Circuit diagram>  
 (Example of a spacer with a built-in single valve)

**Back pressure check valve assembly [-B]**  
**VVQ2000-18A**

It prevents cylinder malfunction caused by other valve exhaust entry. Insert it into R (EXH) port on the manifold side of a valve which is affected. It is effective when a single-acting cylinder is used or an exhaust center type solenoid valve is used.

When ordering assemblies incorporated with a manifold, add suffix "-B" to the end of the manifold part number.  
 Note) When a check valve for back pressure prevention is desired and is to be installed only in certain manifold stations, clearly indicate the part number and specify the mounting position by means of the manifold specification sheet.

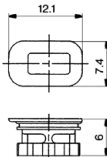
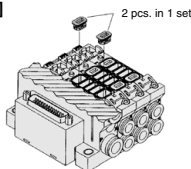

(Precautions)

1. The manifold installed type back pressure check valve assembly is assembly parts with a check valve structure. However, since slight air leakage against the back pressure is allowed due to its structure, adverse effects of the back pressure due to increase in exhaust resistance cannot be prevented if the manifold exhaust port and other exhaust ports are put together for piping or if the piping diameter is narrowed. As a result, this may cause the actuator and air operated equipment to malfunction. So, be careful not to restrict the exhaust air.
2. When a back pressure check valve is mounted, the effective area of the valve will decrease by about 20%.

**Name plate [-N]**  
**VVQ2000-N-Station (1 to Max. stations) (-X4)**

-X4: For mounting slide locking type manual valve

It is a transparent resin plate for placing a label that indicates solenoid valve function, etc. Insert it into the groove on the side of the end plate and bend it as shown in the figure.  
 When the slide locking type manual valve is mounted, it automatically will be "VVQ2000-N-n-X4"  
 When ordering this option incorporated with a manifold, suffix "-N" to the end of the manifold part number.

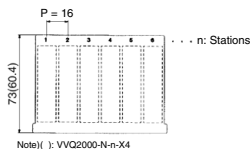
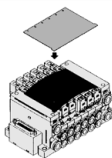

Note) (-): VVQ2000-N-n-X4

**Blanking plug (For One-touch fittings)**  
**KQ2P-□**

It is inserted into an unused cylinder port and SUP/EXH ports. Purchasing order is available in units of 10 pieces.

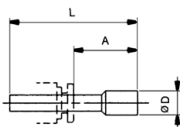
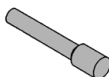

**Dimensions**

Applicable fitting size ød	Model	A	L	D	Applicable fitting size ød	Model	A	L	D
4	KQ2P-04	16	32	6	5/32"	KQ2P-03	16	32	6
6	KQ2P-06	18	35	8	1/4"	KQ2P-07	18	35	8.5
8	KQ2P-08	20.5	39	10	5/16"	KQ2P-09	20.5	39	10
10	KQ2P-10	22	43	12	3/8"	KQ2P-11	22	43	11.5

**Port plug**  
**VVQ1000-58A**

The plug is used to block the cylinder port.  
 When ordering a plug incorporated with a manifold, indicate "CM" for the port size of the manifold part number, as well as, the mounting position and number of stations and cylinder port mounting positions, A and B by means of the manifold specification sheet.

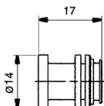
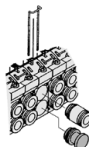

# VQ2000 Series

## VQ2000: Manifold Optional Parts

### DIN rail mounting bracket [-D/-D0/-D□]

#### VVQ2000-57A

It is used for mounting a manifold on a DIN rail.

\* When ordering this option incorporated with a manifold, suffix "-D" to the end of the manifold part number.

1 set of DIN rail mounting bracket is used for 1 manifold (2 DIN rail mounting brackets).

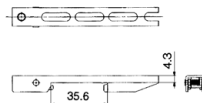
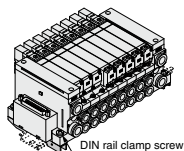

### Direct EXH outlet with built-in silencer [-S]

This is a type with an exhaust port atop the manifold end plate. The built-in silencer exhibits an excellent noise suppression effect. (Noise reduction: 30 dB)

\* When ordering this option incorporated with a manifold, suffix "-S" to the end of the manifold part number.

Note 1) A large quantity of drainage generated in the air source results in exhaust of air together with drainage.

Note 2) When used in combination with "W" (IP65 specification), keep the exhaust port from coming into direct contact with water or other liquids. (T, L, S, and M kits)

● Refer to page 443 for maintenance.

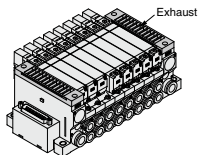

### Silencer (For EXH port)

This silencer is to be inserted into the EXH port (One-touch fittings).

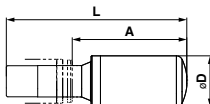

#### Dimensions

Series	Applicable fitting size φd	Model	A	L	D	Effective area (mm <sup>2</sup> ) (Cv factor)	Noise reduction (dB)
VQ2000	10	AN20-C10	36.5	57.5	16.5	30	30

### Elbow fitting assembly

#### VVQ2000-F-L(C4/C6/C8/N3/N7/N9)

It is used for piping that extends upward or downward from the manifold.

When not installed in the manifold stations, specify the assembly part number and the mounting position by means of the manifold specification sheet.

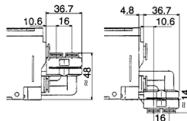

### Dual flow fitting assembly

#### VVQ2000-52A-C10

This is a fitting to multiply the flow rate by combining the outputs of 2-valve stations. It is used for driving a large bore cylinder. This is a One-touch fitting for a port size of φ10 or φ3/8".

\* The port size for the manifold part number is "MM".

Clearly indicate the dual flow fitting assembly part number and specify the mounting position by means of the manifold specifications.

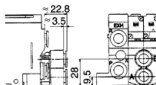



## Manifold Option

### Double check block (Separated) for VQ2000

VQ2000-FPG-□□-□□

It is mounted on the outlet side piping to keep the cylinder in the intermediate position for a long time. Combining the double check block with a 3-position exhaust center solenoid valve will enable the cylinder to stop in the middle or maintain its position for long periods of time.

The combination with a 2-position single/double solenoid valve will prevent the dropping at the cylinder stroke end when the SUP residual pressure is released.

### Specifications

Max. operating pressure	0.8 MPa
Min. operating pressure	0.15 MPa
Ambient and fluid temp.	-5 to 50°C
Flow rate characteristics: C	3.0 dm <sup>3</sup> /(s-bar)
Max. operating frequency	180 c.p.m

Note) Based on JIS B 8375-1981 (Supply pressure: 0.5 MPa)

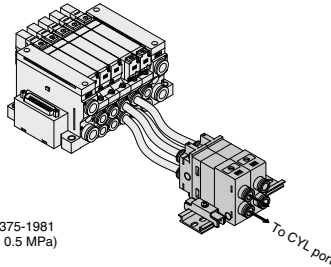

<Circuit diagram>

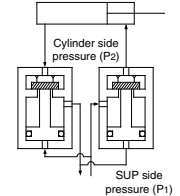

## Dimensions

### Single unit

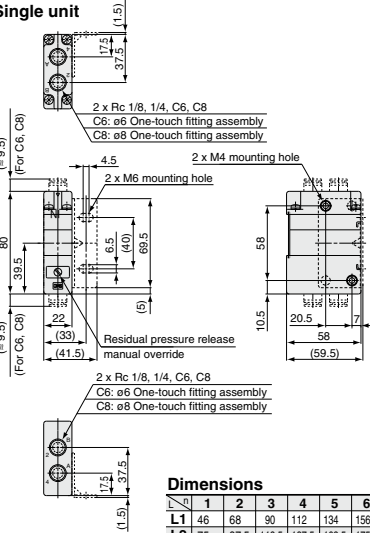

### Manifold

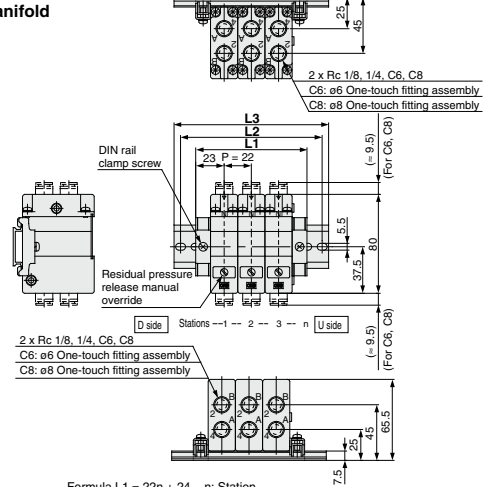

### Dimensions

	1	2	3	4	5	6	7	8	9	10	11	12	13	14	15	16
L1	46	68	90	112	134	156	178	200	222	244	266	288	310	332	354	376
L2	75	87.5	112.5	137.5	162.5	175	200	225	250	262.5	287.5	312.5	337.5	362.5	375	400
L3	85.5	98	123	148	173	185.5	210.5	235.5	260.5	273	298	323	348	373	385.5	410.5

Formula L1 = 22n + 24 n: Station

## How to Order

### Double check block

VQ2000-FPG-01 01 - F

#### IN side port size

01	Rc 1/8
02	Rc 1/4
C6	ø6 One-touch fitting
C8	ø8 One-touch fitting
N7	ø1/4" One-touch fitting
N9	ø5/16" One-touch fitting

#### OUT side port size

01	Rc 1/8
02	Rc 1/4
C6	ø6 One-touch fitting
C8	ø8 One-touch fitting
N7	ø1/4" One-touch fitting
N9	ø5/16" One-touch fitting

#### Option

Nil	None
D	DIN rail mounting (For manifold)
F	With bracket
N	Name plate

Note) When two or more symbols are specified, indicate them alphabetically. Example) -DN

### Manifold (DIN rail mounting)

VVQ2000-FPG-06

#### Stations

01	1 station
...	...
16	16 stations

When ordering a double check block, order the DIN rail mounting [-D].

#### <Ordering Example>

VVQ2000-FPG-06-6-station manifold

\*VQ2000-FPG-

C6C6-D, 3 sets

\*VQ2000-FPG-

C8C8-D, 3 sets

Double check block

#### Bracket Assembly

Part no.	Tightening torque
VQ2000-FPG-FB	0.8 to 1.0 N·m

### <Example>

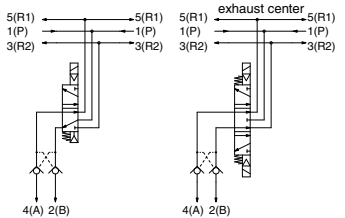

## Caution

- Air leakage from the pipe between the valve and cylinder or from the fittings will prevent the cylinder from stopping for long periods of time. Check the leakage using neutral household detergent, such as dish washing soap. Also check the cylinder's tube gasket, piston packing and rod packing for air leakage.
- Since One-touch fittings allow slight air leakage, screw piping is recommended when stopping the cylinder in the middle for long periods of time.
- Combining double check block with 3-position closed center or pressure center solenoid valve will not work.
- When fittings, etc. are being screwed to the double check block, tighten them with the torque below.

Connection threads	Proper tightening torque (N·m)
Rc 1/8	7 to 9
Rc 1/4	12 to 14

- If the exhaust of the double check block is restricted too much, the cylinder may not operate properly and may not stop immediately.
- Set the cylinder load so that the cylinder pressure will be within two times that of the supply pressure.

# VQ2000 Series

## Manifold Option

### Double check block (Direct mounting)

VVQ2000-23A-C4

Symbol	Port size	Piping direction
C3	With One-touch fitting for ø 3.2	Top
C4	With One-touch fitting for ø 4	Top
C6	With One-touch fitting for ø 6	Top
C8	With One-touch fitting for ø 8	Top
B3	With One-touch fitting for ø 3.2	Bottom
B4	With One-touch fitting for ø 4	Bottom
B6	With One-touch fitting for ø 6	Bottom
B8	With One-touch fitting for ø 8	Bottom

It is mounted directly on the manifold to keep the cylinder in the intermediate position for a long time. Combining the double check block with a built-in pilot type double check valve and a 3-position exhaust center solenoid valve will enable the cylinder to stop in the middle or maintain its position for long periods of time. The combination with a 2-position single/double solenoid valve will permit this block to be used for preventing the dropping at the cylinder stroke end when the SUP residual pressure is released.

### <Check valve operation principle>

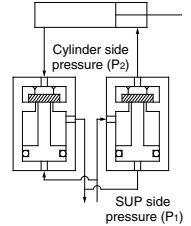
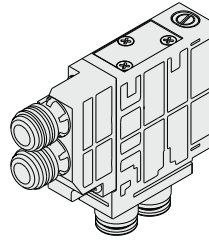

## Specifications

Max. operating pressure	0.7 MPa
Min. operating pressure	0.15 MPa
Ambient and fluid temperature	-5 to 50°C
Flow rate characteristics: C	1.8 dm <sup>3</sup> /(s·bar)
Max. operating frequency	180 c.p.m

## Dimensions

### Single unit

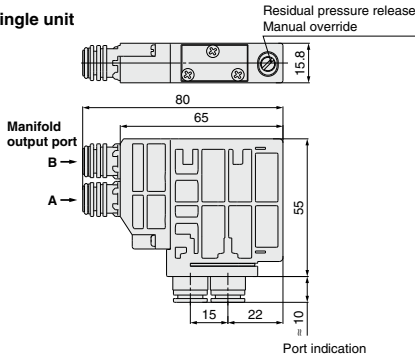

### When the manifold is mounted.

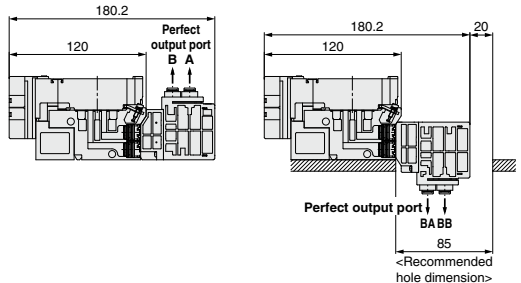

Top ported (VVQ2000-23A-C□) Bottom ported (VVQ2000-23A-B□)

2 x Perfect output port (out side)

C3: With ø3.2 One-touch fitting (for top ported)

C4: With ø4 One-touch fitting (for top ported)

C6: With ø6 One-touch fitting (for top ported)

C8: With ø8 One-touch fitting (for top ported)

B3: With ø3.2 One-touch fitting (for bottom ported)

B4: With ø4 One-touch fitting (for bottom ported)

B6: With ø6 One-touch fitting (for bottom ported)

B8: With ø8 One-touch fitting (for bottom ported)

Residual pressure release  
Manual override  
Color: red

### <Port indication>

Piping direction	Manifold output port	Perfect output port
Top	A	A
	B	B
Bottom	A	BA
	B	BB

### <Example>

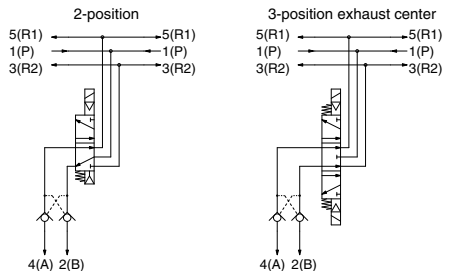

### ⚠ Caution

- Air leakage from the pipe between the valve and cylinder or from the fittings will prevent the cylinder from stopping for long periods of time. Check the leakage using neutral household detergent, such as dish washing soap.
- Also check the cylinder's tube gasket, piston packing and rod packing for air leakage.
- Since zero air leakage is not guaranteed, it is sometimes not possible to hold a stop position for long periods of time.
- Combining double check block with 3-position closed center or pressure center solenoid valve will not work.
- Set the cylinder load so that the cylinder pressure will be within two times that of the supply pressure.
- If the exhaust of the double check block is restricted too much, the cylinder may not operate properly and may not stop intermediately.
- The perfect output port may vary depending on the piping direction. Perform the piping work after checking the port indication.

# Plug-in Unit

## Base Mounted

# VQ1000 Series



### How to Order Valves

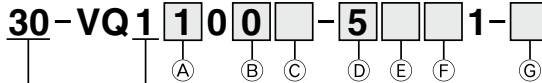

Conforming to UL standard

VQ1000 series

#### (A) Type of actuation

<b>1</b>	<p>2-position single</p> <p>(A)4 2(B)</p> <p>(R1)5 1 3(R2) (P)</p>	<b>Note A</b>	<p>4-position dual 3-port valve</p> <p>(A) 4(A) 2(B)</p> <p>5(R1) 1(P) 3(R2) N.C. N.C.</p>
<b>2</b>	<p>2-position double (Metal)</p> <p>(A)4 2(B)</p> <p>(R1)5 1 3(R2) (P)</p>	<b>Note B</b>	<p>4-position dual 3-port valve</p> <p>(B) 4(A) 2(B)</p> <p>5(R1) 1(P) 3(R2) N.O. N.O.</p>
	<p>2-position double (Rubber)</p> <p>(A)4 2(B)</p> <p>(R1)5 1 3(R2) (P)</p>	<b>Note C</b>	<p>4-position dual 3-port valve</p> <p>(C) 4(A) 2(B)</p> <p>5(R1) 1(P) 3(R2) N.C. N.O.</p>
<b>3</b>	<p>3-position closed center</p> <p>(A)4 2(B)</p> <p>(R1)5 1 3(R2) (P)</p>	<b>Note</b> Rubber seal only	
<b>4</b>	<p>3-position exhaust center</p> <p>(A)4 2(B)</p> <p>(R1)5 1 3(R2) (P)</p>		
<b>5</b>	<p>3-position pressure center</p> <p>(A)4 2(B)</p> <p>(R1)5 1 3(R2) (P)</p>		

#### (B) Seal

<b>0</b>	Metal seal
<b>1</b>	Rubber seal

#### (C) Function

<b>Nil</b>	Standard (0.4 W)
<b>B</b>	High-speed response type (0.95 W)
<b>K</b> <small>Note 2</small>	High-pressure type (1.0 MPa, 0.95 W)
<b>N</b> <small>Note 3</small>	Negative common
<b>R</b> <small>Note 4</small>	External pilot

**Note 1** When two or more symbols are specified, indicate them alphabetically. However, combination of "B" and "K" is not possible.

**Note 2** Metal seal only

**Note 3** When "COM." is specified for the SI unit, select and mount the valve of negative common.

**Note 4** Dual 3-port is not applicable.

#### (D) Coil voltage

<b>5</b> <small>Note</small>	24 VDC
<b>6</b>	12 VDC

**Note** Only 24 VDC is available with the S kit.

#### (E) Light/surge voltage suppressor

<b>Nil</b>	Yes
<b>E</b> <small>Note 1, 2</small>	None (Non-polar)

**Note 1** Not applicable to the S kit.

**Note 2** A combination of "Function N (Negative common)" and "E" is unavailable.

Since "E" has no polarity, it can also be used as a negative common. Selection of "Function N" is not required.

#### (F) Manual override

**Nil:** Non-locking push type (Tool required)

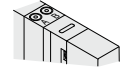

**B:** Locking type (Tool required)

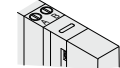

**C:** Locking type (Manual)

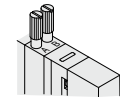

**D:** Slide locking type (Manual)

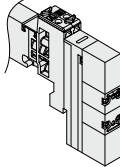

#### (G) CE-compliant

<b>Nil</b>	—
<b>Q</b>	CE-compliant

Refer to the standard product for specifications and dimensions.

SV
SYJ
SZ
VF
VP4
VQ 1/2
VQ 4/5
VQC 1/2
VQC 4/5
VQZ
SQ
VFS
VFR
VQ7

# Plug-in Unit

## Base Mounted

# VQ2000 Series



### How to Order Valves

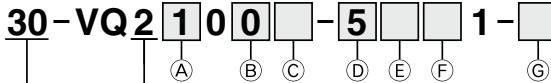

Conforming to UL standard

VQ2000 series

#### (A) Type of actuation

<b>1</b>	<p>2-position single</p> <p>(A)4 2(B)</p> <p>(R1)5 1 3(R2) (P)</p>	<b>Note A</b>	<p>4-position dual 3-port valve</p> <p>(A) 4(A) 2(B)</p> <p>5(R1) 1(P) 3(R2) N.C. N.C.</p>
<b>2</b>	<p>2-position double (Metal)</p> <p>(A)4 2(B)</p> <p>(R1)5 1 3(R2) (P)</p>	<b>Note B</b>	<p>4-position dual 3-port valve</p> <p>(B) 4(A) 2(B)</p> <p>5(R1) 1(P) 3(R2) N.O. N.O.</p>
<b>3</b>	<p>2-position double (Rubber)</p> <p>(A)4 2(B)</p> <p>(R1)5 1 3(R2) (P)</p>	<b>Note C</b>	<p>4-position dual 3-port valve</p> <p>(C) 4(A) 2(B)</p> <p>5(R1) 1(P) 3(R2) N.C. N.O.</p>
<b>4</b>	<p>3-position closed center</p> <p>(A)4 2(B)</p> <p>(R1)5 1 3(R2) (P)</p>	(Note) Rubber seal only	
<b>5</b>	<p>3-position exhaust center</p> <p>(A)4 2(B)</p> <p>(R1)5 1 3(R2) (P)</p>		
<b>5</b>	<p>3-position pressure center</p> <p>(A)4 2(B)</p> <p>(R1)5 1 3(R2) (P)</p>		

#### (B) Seal

<b>0</b>	Metal seal
<b>1</b>	Rubber seal

#### (C) Function

Nil	Standard (0.4 W)
<b>B</b>	High-speed response type (0.95 W)
<b>K</b> Note 2)	High-pressure type (1.0 MPa, 0.95 W)
<b>N</b> Note 3)	Negative common
<b>R</b> Note 4)	External pilot

Note 1) When two or more symbols are specified, indicate them alphabetically. However, combination of "B" and "K" is not possible.

Note 2) Metal seal only

Note 3) When "COM." is specified for the SI unit, select and mount the valve of negative common.

Note 4) Dual 3-port type is not applicable.

#### (D) Coil voltage

<b>5</b> Note 1)	24 VDC
<b>6</b>	12 VDC

Note 1) Only 24 VDC is available with the S kit.

#### (E) Light/surge voltage suppressor

Nil	Yes
<b>E</b> Note 1, 2)	None (Non-polar)

Note 1) Not applicable to the S kit.

Note 2) A combination of "Function N (Negative common)" and "E" is unavailable. Since "E" has no polarity, it can also be used as a negative common. Selection of "Function N" is not required.

#### (F) Manual override

Nil: Non-locking push type (Tool required)

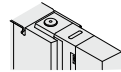

**B:** Locking type (Tool required)

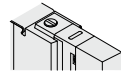

**C:** Locking type (Manual)

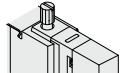

**D:** Slide locking type (Manual)

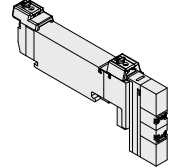

#### (G) CE-compliant

Nil	—
<b>Q</b>	CE-compliant

Refer to the standard product for specifications and dimensions.



# VQ1000/2000 Series

## Specific Product Precautions 1

Be sure to read this before handling the products.

Refer to back page 50 for Safety Instructions and pages 3 to 9 for 3/4/5 Port Solenoid Valve Precautions.

### Light/Surge Voltage Suppressor

#### ⚠ Caution

The lighting positions are concentrated on one side for both single solenoid type and double solenoid type. In the double solenoid type, A side and B side energization are indicated by two colors which match the colors of the manual overrides.

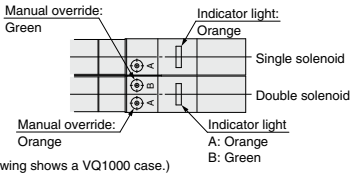

#### DC circuit diagram

##### Single solenoid

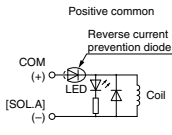

##### Double solenoid

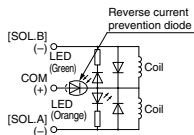

Note) A-side energization:  
A light (Orange) illuminates.  
B-side energization:  
B light (Green) illuminates.

With wrong wiring prevention (stop diode) mechanism  
With a surge absorption (surge absorption diode) mechanism

### Manual Override

#### ⚠ Warning

Without an electric signal for the solenoid valve the manual override is used for switching the main valve. Push type is standard. (Tool required) Locking type is semi-standard. (Tool required/Manual)

##### ■ Push type (Tool required)

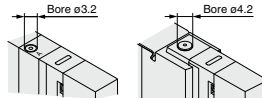

VQ1000

VQ2000

Push down on the manual override with a small screwdriver, etc. until it stops. Release the screwdriver and the manual override will return.

##### ■ Locking type (Tool required) <Semi-standard>

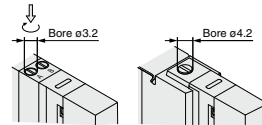

VQ1000

VQ2000

Push down on the manual override with a flat head screwdriver until it stops. Turn it clockwise by 90° to lock it. Turn it counterclockwise to release it.

##### ■ Locking type (Manual) <Semi-standard>

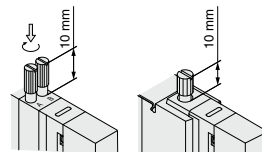

VQ1000

VQ2000

Push down on the manual override with a small flat head screwdriver or with your fingers until it stops. Turn it clockwise by 90° to lock it. Turn it counterclockwise to release it.

#### ⚠ Caution

Do not apply excessive torque when turning the locking type manual override. (0.1 N·m or less)

SV

SYJ

SZ

VF

VP4

VQ 1/2

VQ 4/5

VQC 1/2

VQC 4/5

VQZ

SQ

VFS

VFR

VQ7



# VQ1000/2000 Series

## Specific Product Precautions 2

Be sure to read this before handling the products.

Refer to back page 50 for Safety Instructions and pages 3 to 9 for 3/4/5 Port Solenoid Valve Precautions.

### Manual Override

#### Warning

■ Slide locking type (Manual) <Semi-standard>

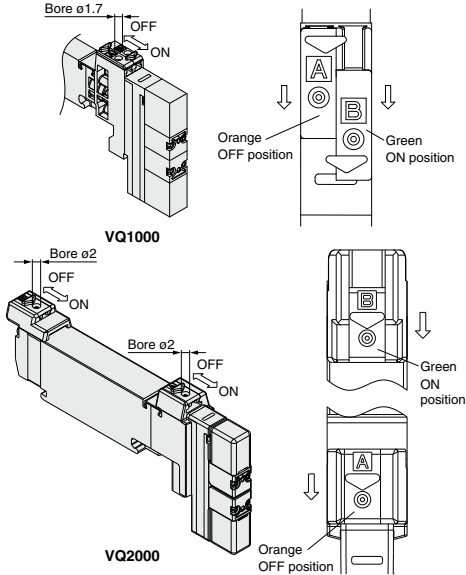

The manual override is locked by sliding it all the way to the pilot valve side (ON side) with a small flat head screwdriver or finger. Slide it to the fitting side (OFF side) to release it. In addition, it can also be used as a push type by using a screwdriver, etc., of  $\phi 1.7$  or less. ( $\phi 2$  or less for VQ2000).

### How to Mount/Remove Solenoid Valves

#### Caution

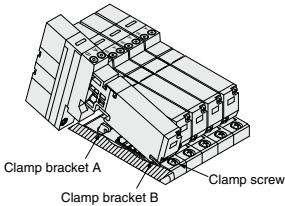

#### Removing

1. Loosen the clamp screw until it turns freely. (The screw is captive.)
2. Lift the coil side of the valve body while pressing down slightly on the screw head and remove it from the clamp bracket B. When the screw head cannot be pressed easily, gently press the area near the manual override of the valve.

### How to Mount/Remove Solenoid Valves

#### Caution

#### Mounting

1. Press down on the clamp screw. Clamp bracket A opens. Diagonally insert the hook on the valve end plate side into clamp B.
2. Press the valve body downward. (When the screw is released, it will be locked by clamp bracket A.)
3. Tighten the clamp screw. (Proper tightening torque: VQ1000, 0.25 to 0.35 N·m; VQ2000, 0.5 to 0.7 N·m.)

#### Caution

Dust on the sealing surface of the gasket or solenoid valve can cause air leakage.

### Replacement of Cylinder Port Fittings

#### Caution

The cylinder port fittings are a cassette for easy replacement. The fittings are blocked by a clip. Take out the clip with a flat head screwdriver, etc., then replace the fittings.

For mounting, insert the fitting assembly until it strikes against the inside wall and then insert the clip to the specified position.

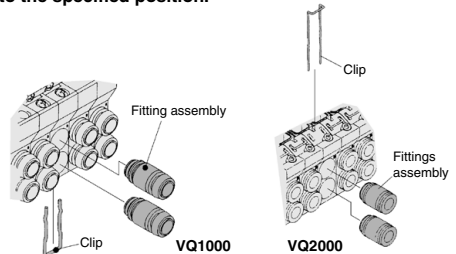

Applicable tubing O.D.	Fitting assembly part no.	
	VQ1000	VQ2000
Applicable tubing $\phi 3.2$	VVQ1000-50A-C3	—
Applicable tubing $\phi 4$	VVQ1000-50A-C4	VVQ1000-51A-C4
Applicable tubing $\phi 6$	VVQ1000-50A-C6	VVQ1000-51A-C6
Applicable tubing $\phi 8$	—	VVQ1000-51A-C8
M5	VVQ1000-50A-M5	—
Applicable tubing $\phi 1/8"$	VVQ1000-50A-N1	—
Applicable tubing $\phi 5/32"$	VVQ1000-50A-N3	VVQ1000-51A-N3
Applicable tubing $\phi 1/4"$	VVQ1000-50A-N7	VVQ1000-51A-N7
Applicable tubing $\phi 5/16"$	—	VVQ1000-51A-N9

\* Refer to "Manifold Optional Parts" on pages 429, 430, 436 for other types of fittings.

#### Caution

1. Use caution that O-rings must be free from scratches and dust. Otherwise, air leakage may result.
2. After screwing in the fittings, mount the M5 fitting assembly on the manifold base. (Tightening torque: 0.8 to 1.2 N·m)
3. Purchasing order is available in units of 10 pieces.



# VQ1000/2000 Series Specific Product Precautions 3

Be sure to read this before handling the products.

Refer to back page 50 for Safety Instructions and pages 3 to 9 for 3/4/5 Port Solenoid Valve Precautions.

## How to Mount/Remove DIN Rail

### ⚠ Caution

#### Removing

- Loosen the clamp screw on side (a) of the end plate on both sides.
- Lift side (a) of the manifold base and slide the end plate in the direction of (2) shown in the figure to remove.

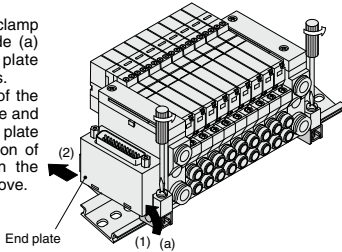

#### Mounting

- Hook side (b) of the manifold base on the DIN rail.
- Press down side (a) and mount the end plate on the DIN rail. Tighten the clamp screw on side (a) of the end plate. (Proper tightening torque: VQ1000, 1.1 to 1.3 N·m; VQ2000, 1.4 to 1.6 N·m.)

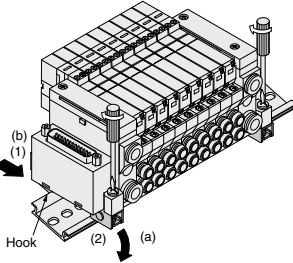

## IP65 Enclosure

### ⚠ Caution

Wiring connection for models conforming to IP65 should also have enclosures equivalent to or of stricter than IP65.

## Built-in Silencer Element

### ⚠ Caution

A filter element is incorporated in the end plate on both sides of the manifold base. A dirty and choked element may reduce cylinder speed or cause malfunction. Clean or replace the dirty element.

#### Element Part No.

Type	Element part no.	
	VQ1000	VQ2000
Built-in silencer, direct exhaust	VVQ1000-82A-1	VVQ2000-82A-1

The minimum order quantity is 10 pcs.

Remove the cover from the top of the end plate and remove the old element with a flat head screwdriver, etc.

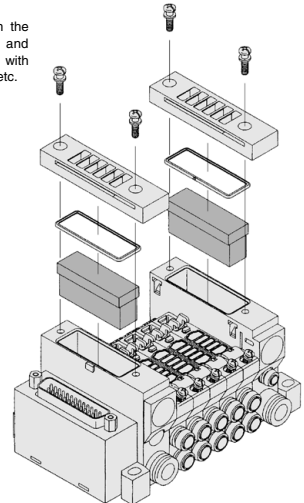

## How to Calculate Flow Rate

Refer to front matters for obtaining the flow rate.

#### ■ Trademark

DeviceNet™ is a trademark of ODVA.  
CompoNet™ is a trademark of ODVA.

- SV
- SYJ
- SZ
- VF
- VP4
- VQ 1/2
- VQ 4/5
- VQC 1/2
- VQC 4/5
- VQZ
- SQ
- VFS
- VFR
- VQ7