

# 4 Port Solenoid Valve

## VQD1000 Series

**Rubber Seal** Direct Operated Poppet Type



### Unprecedented high speed, with stable response times

ON: 4 ms, OFF: 2 ms, Dispersion accuracy ±1 ms (With light/surge voltage suppressor at a supply pressure of 0.5 MPa)  
(Use clean and dry air.)

### Compact and lightweight (34 g) with large flow capacity

Body width of 10 mm, C: 0.22 dm<sup>3</sup>/(s·bar) 2 W  
C: 0.27 dm<sup>3</sup>/(s·bar)  
3.2 W (U type: Large flow)

### Available in vacuum applications (Up to -101.2 kPa)

Can be used in vacuum/release circuits  
When used as a 3 port valve, conversion from N.O. to N.C. and vice versa is possible by plugging either port 4(A) or 2(B).

### Clean room specifications available as special.

Since the main valve has no sliding seals, non-oil treatment specification at the fluid contacting section is available (Made-to-Order part no. X16). The external non-leak specification is also available (10- series).

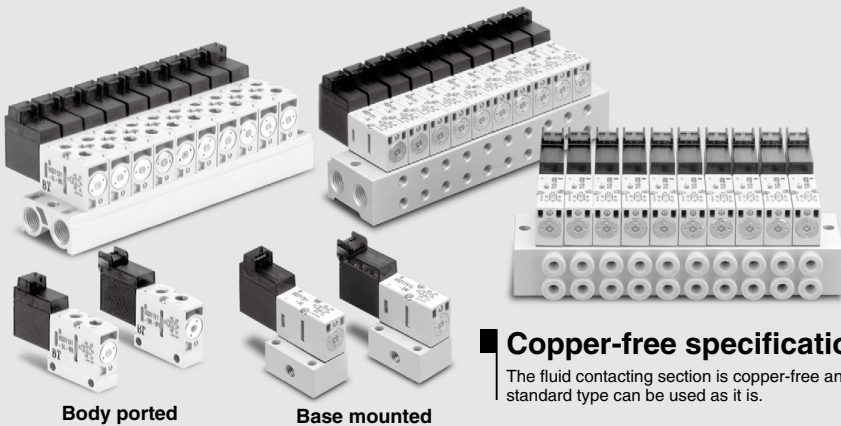

Body ported

Base mounted

### Copper-free specifications

The fluid contacting section is copper-free and the standard type can be used as it is.

## Cylinder Speed Chart

Use as a guide for selection.  
Please confirm the actual conditions with SMC Sizing Program.

### Base Mounted

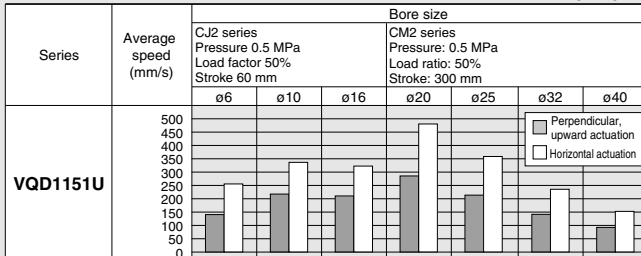

\* It is when the cylinder is extending that is meter-out controlled by speed controller which is directly connected with cylinder, and its needle valve with being fully open.  
 \* The average velocity of the cylinder is what the stroke is divided by the total stroke time.  
 \* Load factor: ((Load weight x 9.8)/Theoretical force) x 100%

### Conditions

	Base mounted	CJ2 series	CM2 series
VQD1151U	Tube bore x Length	TU0425 x 1m	
	Speed controller	AS1201F-M5-04	AS2201F-Q2-04
	Silencer	AN120-M5	

VV061

VV100

V100

S070

VQD

VQD-V

VK

VT

# 4 Port Solenoid Valve Direct Operated Poppet Type

# VQD1000 Series



## How to Order Valves

VQD1 1 5 1 - 5 L - - -

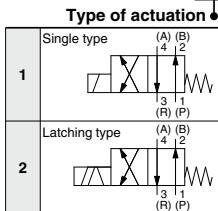

**Body type**

2	Body ported (Single unit)
3	Body ported (Manifold)
5	Base mounted

Note) Latching type: Base mounted type only.

**Valve option**

Nil	Standard
V	Vacuum
U	For large flow <sup>(1)</sup>
W	For large flow, vacuum <sup>(1)</sup>

Note 1) Latching type: U and W only  
Note 2) Latching type (-COM): NU and NW

**Rated voltage**

5	24 VDC
6	12 VDC

Note) Latching type: 24 VDC only

**CE-compliant**

Nil	—
Q	CE-compliant

**Made to Order**

X16 Fluid-contact part: Oil-free

**Port size**

Body ported	M5	M5 thread (Single unit, Manifold)
Base mounted	Nil	Without sub-plate (Manifold)
	M5	M5 thread (Single unit)

\* Fittings with a 10 mm or more width across flats may cause interference.

**Electrical entry**

<b>L:</b> Plug lead type L plug connector, With lead wire With light/surge voltage suppressor	
<b>LO:</b> Plug lead type L plug connector, Without connector With light/surge voltage suppressor	
<b>M:</b> Plug lead type M plug connector, With lead wire With light/ surge voltage suppressor	
<b>MO:</b> Plug lead type M plug connector, Without connector With light/surge voltage suppressor	

Note) When you expect to energize the unit for extended periods of time, refer to page 3 for details.

## Standard Specifications

Item	Type	Standard single type	Large-flow single type	Large-flow latching type
<b>Valve specifications</b>	<b>Valve construction</b>	4 port direct operated poppet valve		
	<b>Fluid</b>	Air		
	<b>Maximum operating pressure</b>	0.7 MPa		
	<b>Minimum operating pressure/Vacuum</b>	0 MPa / -101.2 kPa		
	<b>Response time<sup>(1)</sup></b>	ON: 4ms±1, OFF: 2ms±1		10ms or less
	<b>Ambient and fluid temperature</b>	-10 to 50°C <sup>(2)</sup>		
	<b>Lubrication</b>	Not required		
	<b>Manual override</b>	Non-locking push type		Locking type
	<b>Impact/Vibration resistance<sup>(3)</sup></b>	150/30 m/s <sup>2</sup>		
	<b>Mounting position</b>	Unrestricted		
	<b>Enclosure</b>	Dust tight		
	<b>Electricity specifications</b>	<b>Weight</b>		34 g
<b>Coil rated voltage</b>		DC	24 V, 12 V	24 DC
<b>Allowable voltage fluctuation</b>		±10% of rated voltage		
<b>Coil insulation type</b>		Class B or equivalent		
<b>Power consumption</b>		DC	2 W	3.2 W (Energy saving type) (Inrush: 3.2 W, Holding: 1.0 W) <sup>(4)</sup>
<b>Electrical entry</b>	L plug connector, M plug connector (With indicator light and surge voltage suppressor)			

Note 1) Based on response time measurement, JIS B8419: 2010. (Coil temperature: 20°C, pressure: 0.5 MPa, at rated voltage, with light and surge suppressor, valve at operation excluding restart period) The period immediately after a restart may be delayed for about 1 msec depending on operating conditions.

Note 2) Operating the valve at low temperatures may cause condensate to form, therefore dry air must be used.

Note 3) Impact resistance: No malfunction occurred when it is tested with a drop tester in the axial direction and at the right angles to the main valve and armature in both energized and de-energized states every once for each condition. (Values at the initial period)

Vibration resistance: No malfunction occurred in a one-sweep test between 45 and 2000 Hz. Test was performed at both energized and de-energized states in the axial direction and at the right angles to the main valve and armature. (Values at the initial period)

Note 4) For the start-up time, refer to the energy saving type's electrical power waveform on page 1399 "Wiring Specifications".



L plug connector  
Base mounted



L plug connector  
Body ported



M plug connector  
Base mounted



M plug connector  
Body ported

# 4 Port Solenoid Valve Direct Operated Poppet Type **VQD1000 Series**

## Flow Rate Characteristics

Valve model		Port size	Flow rate characteristics					
			1 → 4/2 (P → A/B)			4/2 → 5/3 (A/B → EA/EB)		
			C [dm <sup>3</sup> /(s·bar)]	b	Cv	C [dm <sup>3</sup> /(s·bar)]	b	Cv
Body ported	VQD1121-□ <sub>h</sub> -M5	M5 x 0.8	0.22	0.16	0.05	0.19	0.31	0.05
	VQD1121 <sup>U</sup> <sub>W</sub> -□ <sub>L</sub> -M5		0.27	0.24	0.07	0.28	0.28	0.07
Base mounted (With sub-plate)	VQD1151-□ <sub>h</sub> -M5		0.22	0.10	0.05	0.22	0.31	0.06
	VQD1151 <sup>U</sup> <sub>W</sub> -□ <sub>L</sub> -M5		0.27	0.25	0.07	0.27	0.28	0.07

## Construction

### Symbol

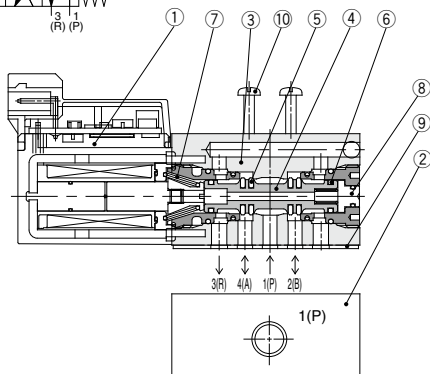
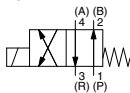

### Component Parts (Single Type)

No	Description	Material	Note
1	Solenoid coil assembly	—	
2	Sub-plate	Aluminum	VQD1000-S-M5 (Base mounted only)
3	Body	ZDC	
4	Spool valve	Aluminum	
5	Poppet	HNBR	
6	Guide ring	Resin	
7	Return spring	Stainless steel	
8	Manual override	Aluminum	
9	Gasket	HNBR	
10	Round head combination screw	Steel	

Note) Body cannot be disassembled.

## Valve Single Unit Option

### Piping plate assembly VQD1000-20A

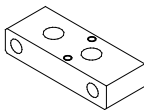

Manifold type (VQD1131) can be changed to single unit type (VQD1121) by mounting plate assembly.

Note) Plate should be mounted with manifold mounting screws (M1.7 x 20).  
Proper tightening torque of thread: 0.18 to 0.25 N·m

VV061

VV100

V100

S070

**VQD**

VQD-V

VK

VT

# VQD1000 Series

## Dimensions/Body Ported

L plug connector: VQD1121□-□L-M5

M plug connector: VQD1121□-□M-M5

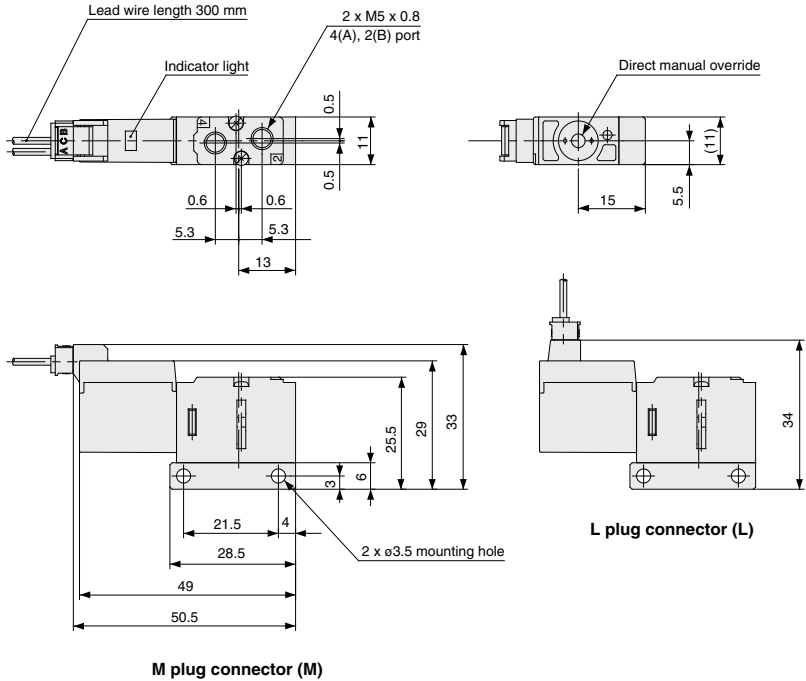

# 4 Port Solenoid Valve Direct Operated Poppet Type **VQD1000 Series**

## Dimensions/Base Mounted

L plug connector: VQD1151□-□L-M5

M plug connector: VQD1151□-□M-M5

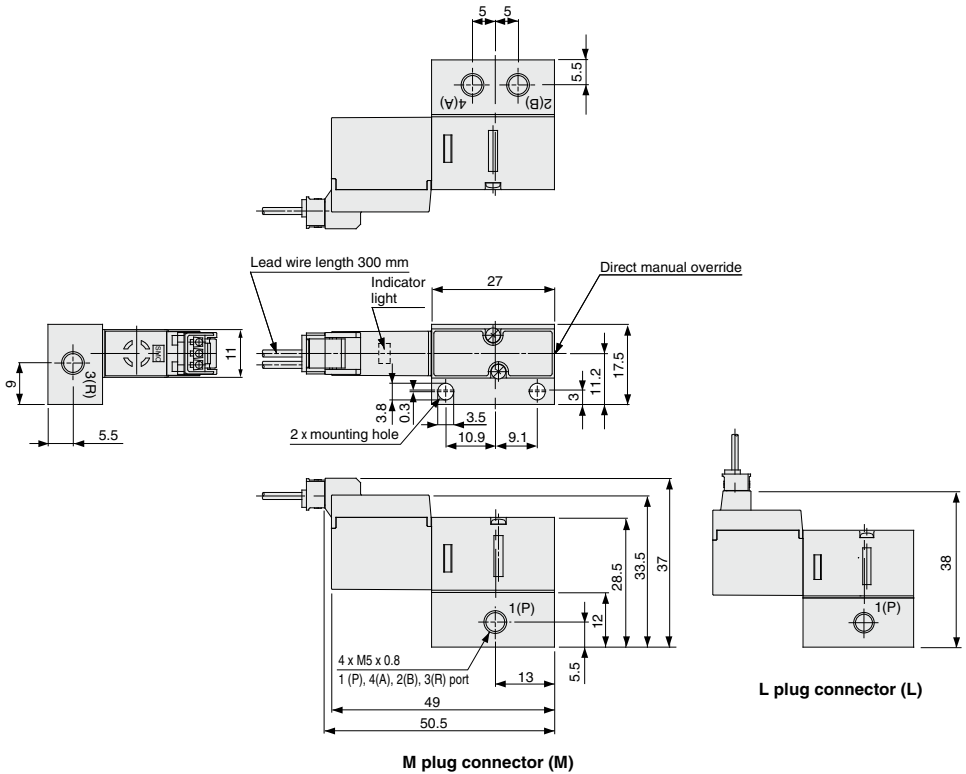

VV061
VV100
V100
S070
<b>VQD</b>
VQD-V
VK
VT

# VQD1000 Series

## Dimensions/Base Mounted

L plug connector: VQD1251□-□L-M5

M plug connector: VQD1251□-□M-M5

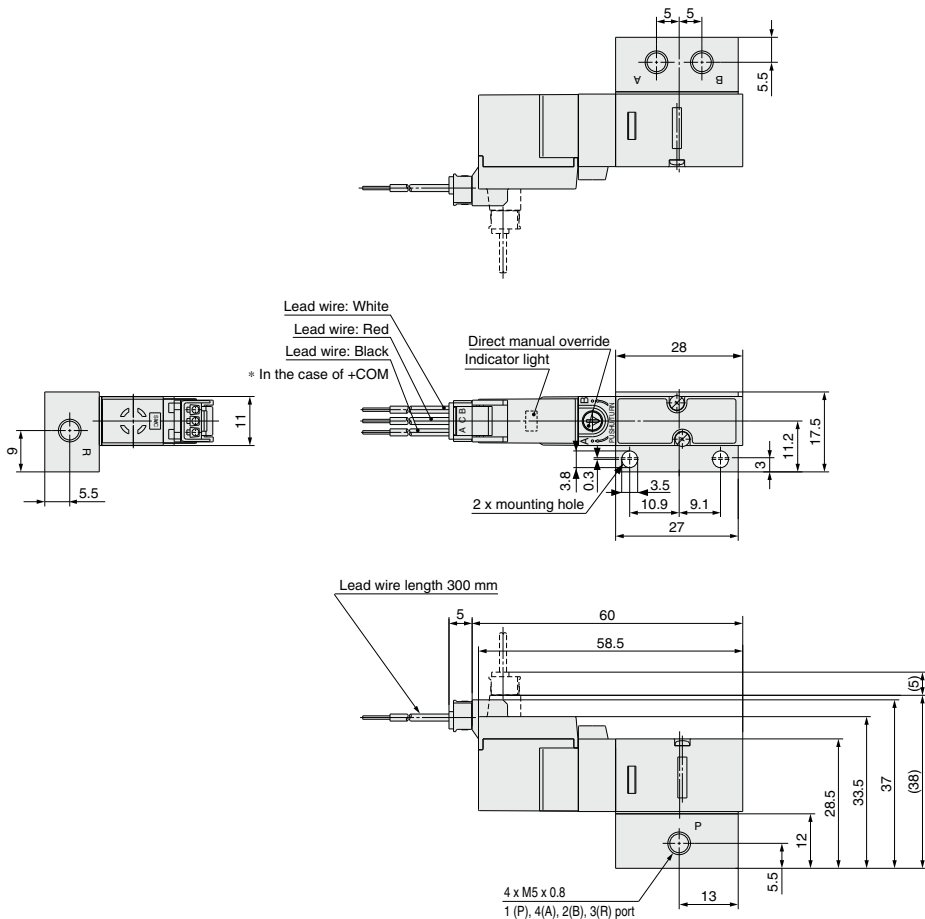

• The dashed line indicates L plug connector.

# 4 Port Solenoid Valve Direct Operated Poppet Type **VQD1000 Series**



## How to Order Manifold

[Option]

## How to Order Valves

[Option]

### Plug lead unit manifold

**VV4QD1** 5 - [ ] - [ ] - [ ]

**Manifold**

2	Body ported
5	Base mounted

**CE-compliant**

Nil	—
Q	CE-compliant

**Valve station**

02	2 stations
⋮	⋮
20	20 stations (Max.)

**Port size(Cylinder port)**

Nil	Body ported	M5 thread
M5	Base mounted	M5 thread
C4		One-touch fitting for ø4

1(P), 3(R) port: Rc 1/8

**VQD1** 1 5 1 [ ] - 5 L - [ ] - [ ]

**Type of actuation**

1	Single type
2	Latching type

**Body type**

3	Body ported
5	Base mounted

Note) Latching type: Base-mounted type only.

**Valve option**

Nil	Standard
V	Vacuum
U <sup>Note)</sup>	For large flow
W <sup>Note)</sup>	For large flow, vacuum

Note 1) Latching type: U and W only  
Note 2) Latching type (-COM): NU and NW

**Rated voltage**

5	24 VDC
6	12 VDC

Note) Latching type: 24 VDC only

**Electrical entry**

<b>L:</b> Plug lead type L plug connector, With lead wire With light/surge voltage suppressor	
<b>LO:</b> Plug lead type L plug connector, Without connector With light/surge voltage suppressor	
<b>M:</b> Plug lead type M plug connector, With lead wire With light/surge voltage suppressor	
<b>MO:</b> Plug lead type M plug connector, Without connector With light/surge voltage suppressor	

**Port size (Body ported only)**

Nil	Base mounted	—
M5	Body ported	M5 thread

**CE-compliant**

Nil	—
Q	CE-compliant

## How to Order Manifold Assembly

Specify the part numbers for valves and options together beneath the manifold base part number.

<Example>

- VV4QD15-05M5.....1 set — Manifold base part no.
- \*VVQD1000-10A-5.....1 set — Blanking plate part no. (1st station)
- \*VQD1151-5L.....4 sets — Valve part no. (2 to 5th station)

Prefix the asterisk to the part nos. of the solenoid valve, etc.

Enter in order starting from the first station on the D side.←

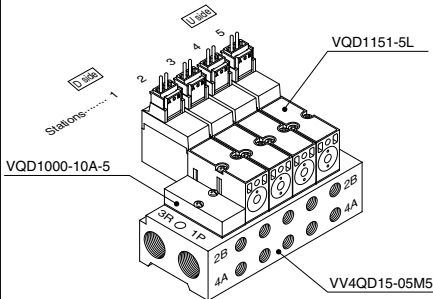

VV061

VV100

V100

S070

**VQD**

VQD-V

VK

VT

# VQD1000 Series

## Manifold Options

### Blanking plate assembly/Body ported

#### VVQD1000-10A-2

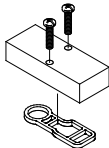

Blanking plate assembly includes 2 screws and gasket

### Blanking plate assembly/Base mounted

#### VVQD1000-10A-5

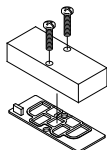

Blanking plate assembly includes 2 screws and gasket

### Individual SUP spacer/Base mounted

#### VVQD1000-P-M5-5

Mount the individual SUP spacer on the manifold base, and thus making it possible to have supply port individually for each valve.

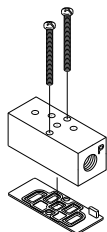

Individual SUP spacer with screw (2 pcs.) and gasket

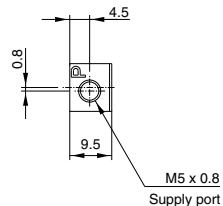
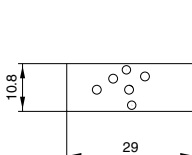

### Individual EXH spacer/Base mounted

#### VVQD1000-R-M5-5

Mount the individual EXH spacer on the manifold base, and thus making it possible to have exhaust port individually for each valve. (Common EXH type)

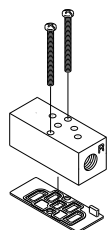

Individual EXH spacer with screw (2 pcs.) and gasket

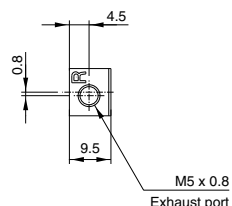
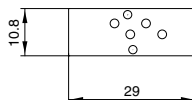



# 4 Port Solenoid Valve Direct Operated Poppet Type **VQD1000 Series**

## Dimensions/Body Ported

### Plug lead unit manifold(VV4QD12-□)

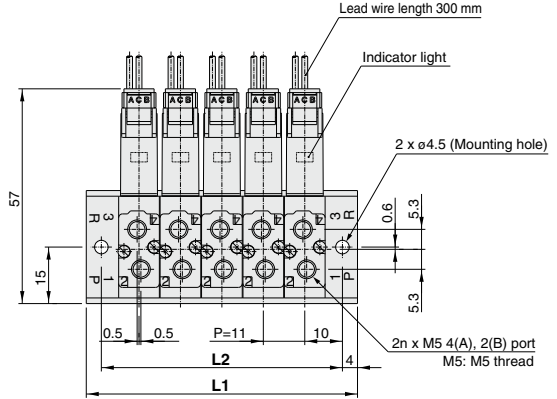
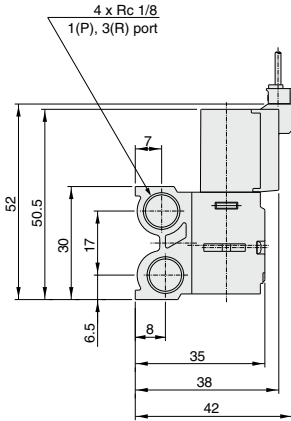

**M plug connector (M)**

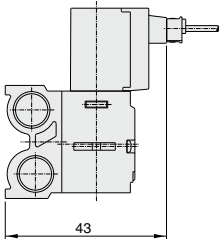

**L plug connector (L)**

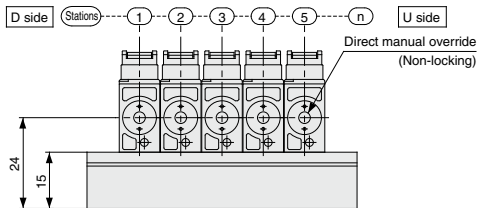

### Dimensions

L	n	n: Stations																		
		2	3	4	5	6	7	8	9	10	11	12	13	14	15	16	17	18	19	20
<b>L1</b>		39	50	61	72	83	94	105	116	127	138	149	160	171	182	193	204	215	226	237
<b>L2</b>		31	42	53	64	75	86	97	108	119	130	141	152	163	174	185	196	207	218	229

VV061

VV100

V100

S070

**VQD**

VQD-V

VK

VT

# VQD1000 Series

## Dimensions/Base Mounted

### Plug lead manifold unit (VV4QD15-□)

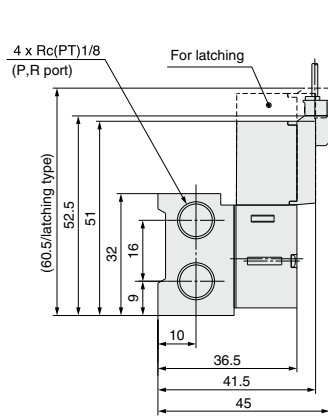

**M plug connector (M)**

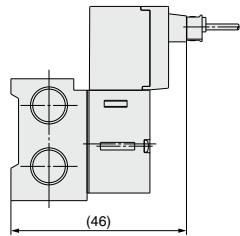
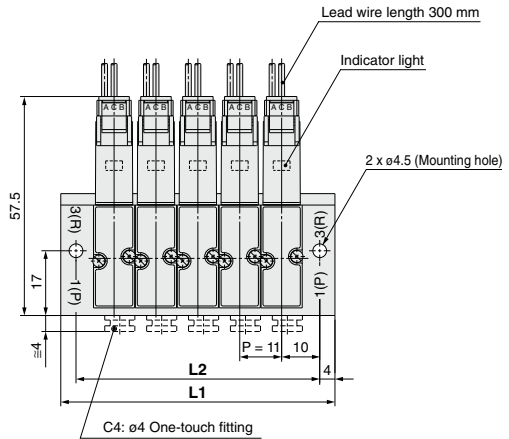

**L plug connector (L)**

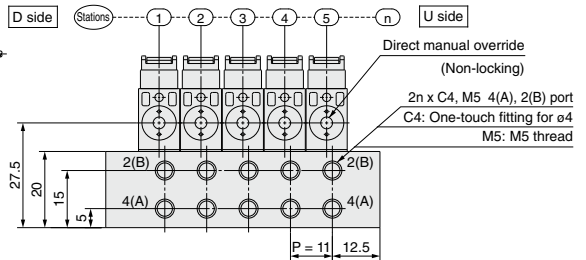

## Dimensions

n: Stations

L \ n	2	3	4	5	6	7	8	9	10	11	12	13	14	15	16	17	18	19	20
<b>L1</b>	39	50	61	72	83	94	105	116	127	138	149	160	171	182	193	204	215	226	237
<b>L2</b>	31	42	53	64	75	86	97	108	119	130	141	152	163	174	185	196	207	218	229



# VQD1000 Series Specific Product Precautions 1

Be sure to read this before handling the products.  
Refer to back page 50 for Safety Instructions and pages 3 to 9 for 3/4/5 Port Solenoid Valve Precautions.

## Manual Override Operation

### ⚠ Warning

Connected actuator is started by manual operation. Use the manual override after confirming that there is no danger.

■ Single type: Non-locking push type (Tool required)

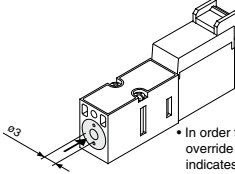

• In order to turn it ON, push down the manual override button in the direction the arrow (→) indicates until it stops (approx. 0.5 mm), and release it to turn it OFF.

■ Latching type: Locking type (Tool required)

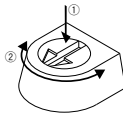
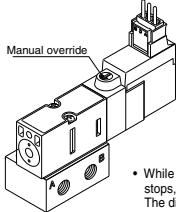

• While pushing down the manual override until it stops, turn it by 90° and stop the arrow at A or B. The direction can be changed as desired.  
(A: Flow path: P → A, B: Flow path: P → B)  
• The manual override is in the locked state when it is released.  
• The locking will be released and the manual override will return, when it is returned to the free position.  
(Note) Be sure to release the locking before starting the normal operation.



Manual override-free position

## Continuous Energization

### ⚠ Warning

- Coil temperature may get high due to ambient temperature or energizing duration. Do not touch the valve by hand directly. When there is such a dangerous case to be touched by hands directly, install a protective cover.
- When you expect to energize the single type for extended periods of time, refer to page 3 for details.
- The latching type should not be energized over 30 seconds. Be sure to wait more than you energize the unit (both A and B should be turned off.) before you move on to the next operation.

## Mounting of Valves

### ⚠ Caution

- After confirming the gasket is correctly placed under the valve, securely tighten the bolts with the proper torque shown in the table below.

Proper tightening torque (N·m)
0.18 to 0.25

## Mounting of Valves

### ⚠ Caution

- When piping and mounting valves, clamp the body part in place to avoid applying force to the coil. If you apply force over 120 N to coil, connection pins deform, which may cause malfunction. (Latching: 50 N or more)

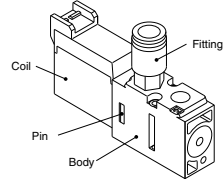

## Wiring Specifications

### ⚠ Caution

- Single type (Standard: 2 W)

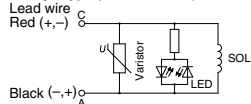

(Note) Coil surge voltage generated when OFF is about 60 V. Please consult with SMC when you need to reduce the surge voltage.

- Single type (Large flow: 3.2 W)

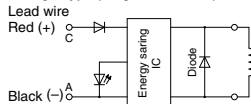

3.2 W type (Energy saving type) reduces current consumption at holding which reduces the overall power consumption using the circuit shown in the left figure. Refer to the energy saving type's electrical power waveform below.

<Energy saving type's electrical power waveform>  
(Rated voltage: 24 VDC)

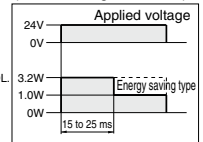

- Latching solenoid type

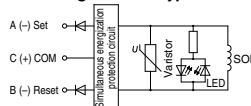

- Positive common

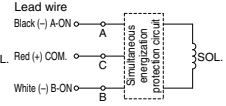

- How to order connector assembly

• Single

AXT661-14A-

• Latching, Positive common

AXT661-13A-

• Latching, Negative common

AXT661-13AN-

Connector and socket (3 pcs.) only

AXT661-12A

- Negative common

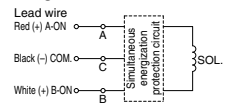

### Lead wire length

Nil	300 mm
6	600 mm
10	1000 mm
20	2000 mm
30	3000 mm

- Plug connector lead wire length

Lead wire length of plug connector valve with lead wire is 300 mm. When ordering a valve with a lead wire of 600 mm or longer, be sure to indicate the model number of the valve without connector and connector assembly.

VV061

VV100

V100

S070

VQD

VQD-V

VK

VT



# VQD1000 Series Specific Product Precautions 2

Be sure to read this before handling the products.  
Refer to back page 50 for Safety Instructions and pages 3 to 9 for 3/4/5 Port Solenoid Valve Precautions.

## Latching

### ⚠ Caution Latching Type

The latching is equipped with a self-holding mechanism, which permits a movable iron core in the solenoid to hold the set (A-ON) and reset (B-ON) positions during momentary energization (50 ms or longer). Therefore, there is no need to energize continuously.

#### < Special Cautions for Latching >

1. Use in a circuit that does not have simultaneous energization of A-ON and B-ON signals.
2. The minimum energization time required for self-holding is 50 ms.
3. Although there is no problem for normal operations and environments, please consult SMC when operating in an environment with vibration (10G or more) or strong magnetic fields.
4. When there is the magnetic body at the valve side, it may cause malfunction.  
Allow a space over 10 mm between the valve and magnetic body.
5. Even though this valve is held on to B-ON position (passage: P → B), it may switch to the set position during transportation or due to impact when mounting valves, etc.  
Therefore, check the initial position by means of power supply or manual override prior to use.

Energization		Passage		Light color
A-ON (Set)	A (-) Black	C (+) Red	P → A (B → R)	Orange
B-ON (Reset)	B (-) White	C (+) Red	P → B (A → R)	Green

Note) For positive common

## How to Use Plug Connector

### ⚠ Caution

#### Attaching and detaching connectors

- To attach a connector, hold the lever and connector unit between your fingers and insert straight onto the pins of the solenoid valve so that the lever's pawl is pushed into the groove and locks.
- To detach a connector, remove the pawl from the groove by pushing the lever downward with your thumb, and pull the connector straight out.

Note) Gently pull the lead wire, otherwise it may cause contact failure or disconnection.

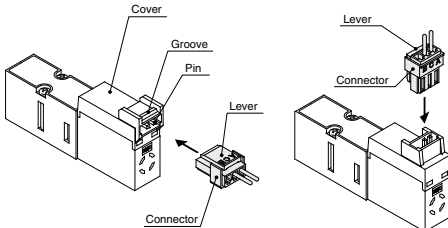

## How to Use the Valve for Vacuum Applications (When used as a 3 port valve)

### ⚠ Caution

Application example of "VQD1 $\frac{1}{2}$  $\frac{3}{4}$ W"

(Symbols used are typical examples.)

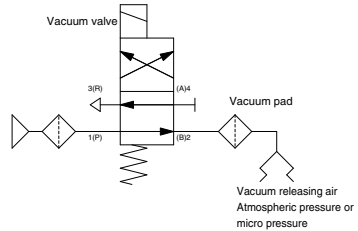

- Use a VQD1 $\frac{1}{2}$  $\frac{3}{4}$ W valve for vacuum applications.  
Connect the vacuum source to the 3(R) port.  
\* Air pressure cannot be applied to the 3(R) port.
- When used as a 3 port valve, conversion from N.O. to N.C. and vice versa is possible by plugging either port 4(A) or 2(B).  
\* Cannot be used as 2 port valve.

## How to Calculate the Flow Rate

For obtaining the flow rate, refer to front matter.