

# Actuator Position Sensor

The actuator stroke position is output with an analog signal.



## Repeatability

# 0.1 mm

Refer to the Specific Product Precautions (pages 9 and 10).

**New** Now with a greater number of models!

- CQS Series Compact Cylinder
- MXH Series Compact Slide
- MXS and MXQ□ Series Air Slide Tables
- MHZ, MHZL2, MHL2, and MHF2 Series Parallel Type Air Grippers

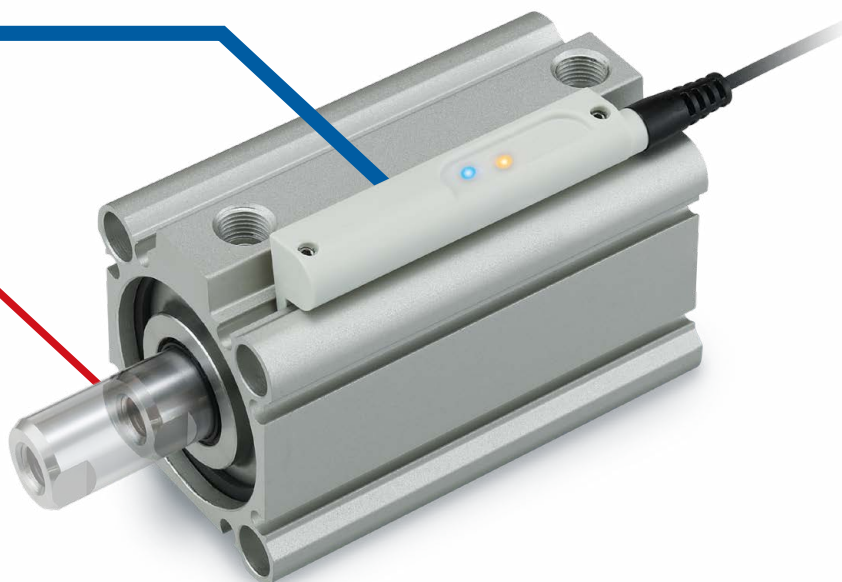

## Analog output

- Voltage output (0 to 10 [V]),  
Current output (4 to 20 [mA])

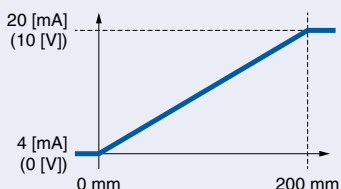

\* For the 0 – 200 mm measurement range

## 4 measurement ranges



## Switch output

- Normal output and reversed output
- 4 measurement modes
- PNP/NPN outputs
- Settable ON/OFF positions

## IO-Link compatible

- Periodic transmission of ON/OFF signal (4 outputs) and position measurement value using one communication line
- Reading of the component information and parameter batch settings with digital communication



## D-MP□ Series



CAT.ES20-257B

## Analog output function

- Measurement range settings can be changed.
- The entire measurement range can be reset using the reset function.
- Analog current output and analog voltage output can be selected.
- Analog output can be reversed.

Example) 4-20 mA → 20-4 mA  
0-10 V → 10-0 V

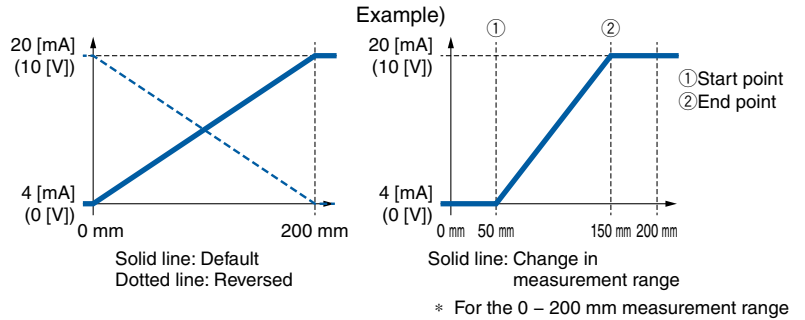

## Operation display



### Teach pad

Setting is possible by simply touching the touch pad.  
(Refer to the list of functions on page 3.)

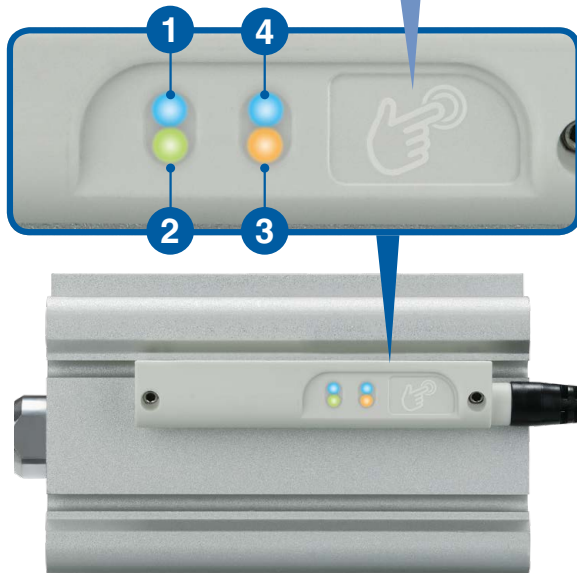

The analog output mode, switch output mode, switch point, and setting stroke range can be set.

Indicator light position	Light indication	Indicator light	Mode
1	Blue light is ON.		Analog current output
2	Green light is ON.		Analog voltage output
	Green light flashes.		IO-Link connection
3	Orange light is ON.		Within the measurement range
	Orange light is OFF.		Outside of the measurement range
	Orange light flashes.		Error - Sensor not ready for operation - Reduced magnetic field strength detected
4	Blue light is ON.		Switch output: High
	Blue light is OFF.		Switch output: Low
	Blue light flashes.		Excessive load on the switch output

## Direct mounting is possible.

Can be mounted directly into the auto switch mounting groove on the cylinder

Applicable cylinders Refer to page 7.

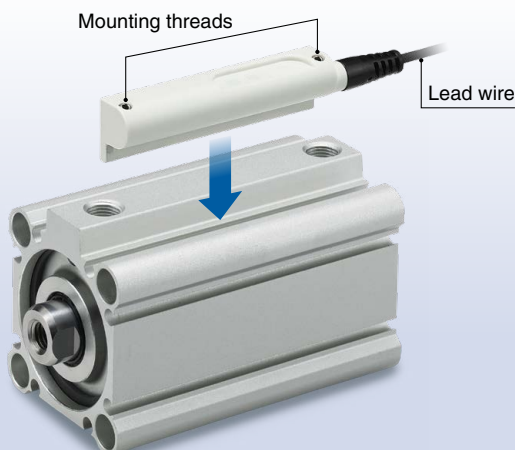

## Lead wire connection



4 switch modes can be selected for the switch output.

**1 Single-point Mode** The output switches when passing through set point 1.

Normal output

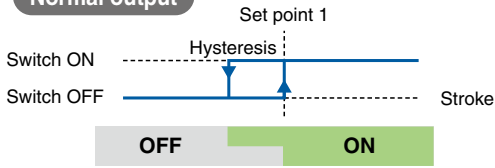

Reversed output

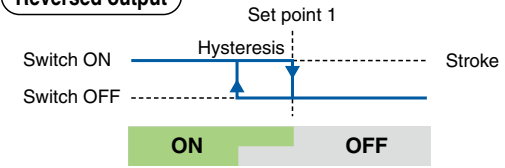

**2 Auto Switch Mode** Set point 1 is at the center of the operating range (the range is approx. 3 mm).

Normal output

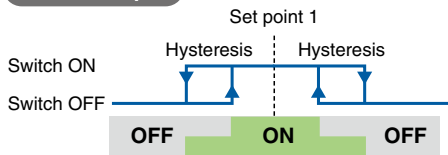

Reversed output

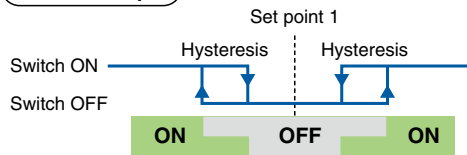

**3 Window Mode** The operating range can be changed by setting set points 1 and 2.

Normal output

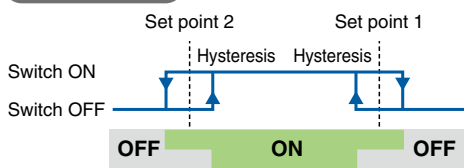

Reversed output

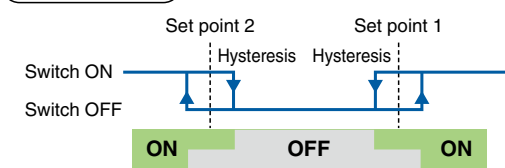

**4 2-Point Mode** Setting is only available in IO-Link mode. Setting of set points 1 and 2 can change the ON and OFF positions.

Normal output

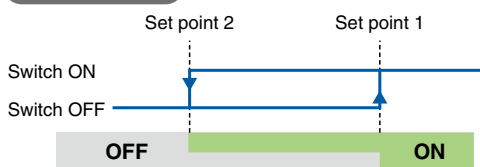

Reversed output

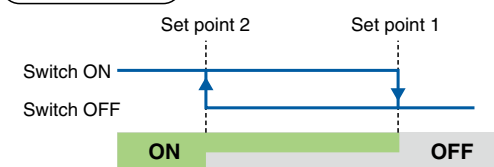

Application examples

For length/width discrimination

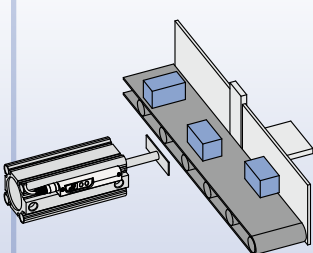

For the detection of the lifter position

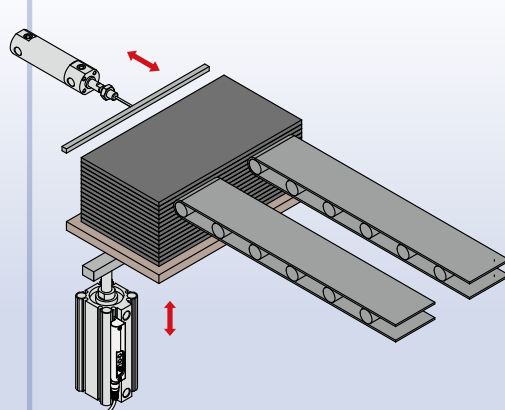

For the inspection of machined holes

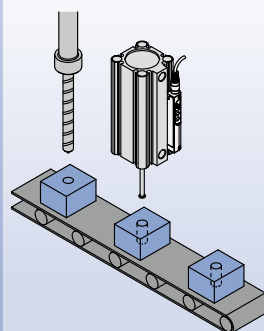

For the measurement of dimensions

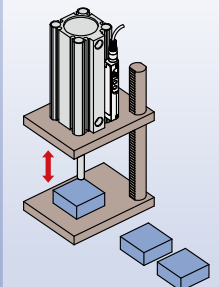

**IO-Link compatible**

**Visualization of operation/equipment status/Remote monitoring and control by communication**

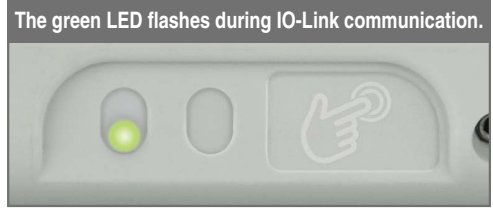
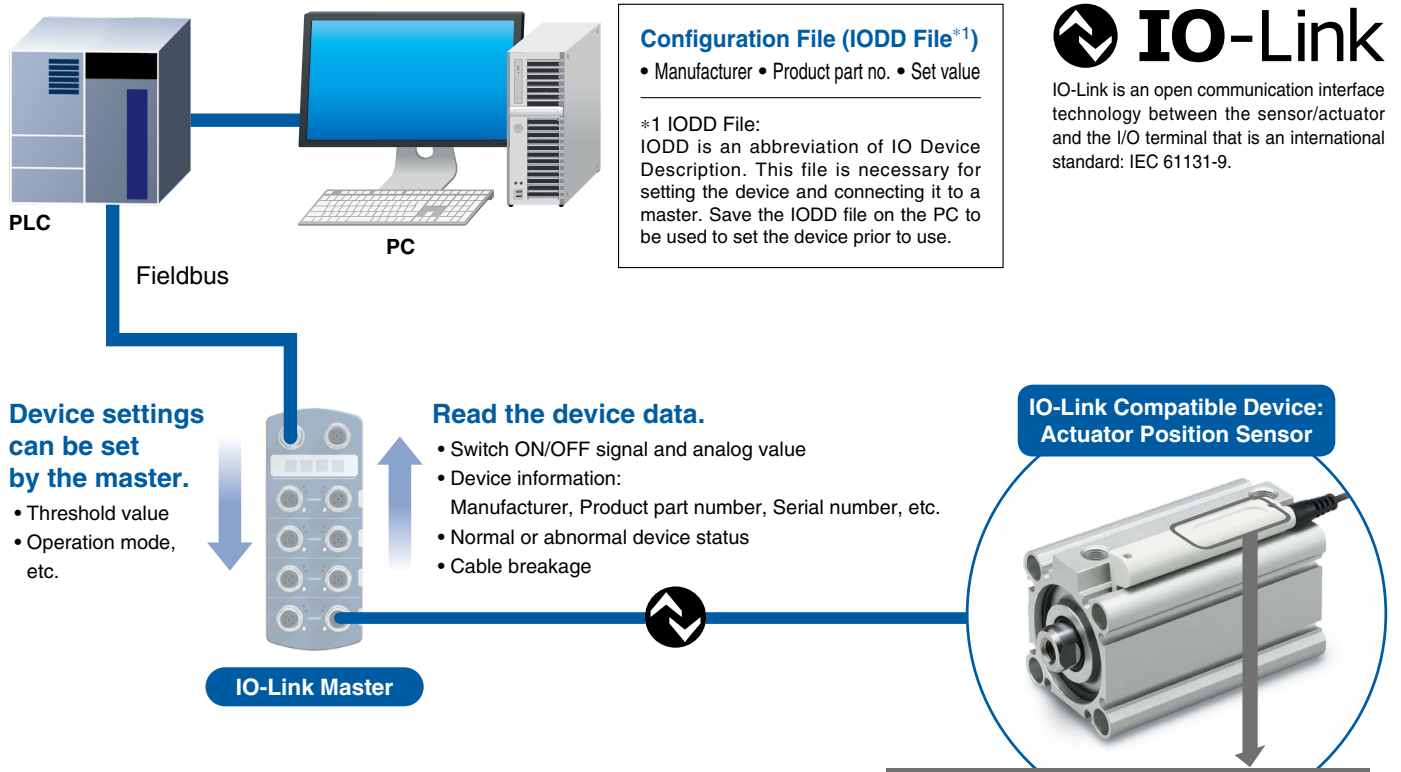

**Actuator position sensor IO-Link specifications**

IO-Link version: V1.1  
 Communication speed: 230.4 [kbps] (COM3)  
 Shortest data update cycle: 1 [ms]

**Process Data**

Bit offset	Item	Note
0	OUT1 output	0: OFF 1: ON
1	OUT2 output	0: OFF 1: ON
2	OUT3 output	0: OFF 1: ON
3	OUT4 output	0: OFF 1: ON
4 to 15	Position measurement value	Unsigned 12 bit

Process data is the data which is exchanged periodically between the master and device. This product process data consists of the switch output status and the position measurement value.

Single-point mode, auto switch mode, window mode, 2-point mode, and normal/reversed output can be individually set at any position for each output (OUT1 to OUT4).

Bit offset	15	14	13	12	11	10	9	8	7	6	5	4	3	2	1	0
Item	Position measurement value												OUT4	OUT3	OUT2	OUT1

**Diagnostics/ Status Monitoring Function**

Internal error
Abnormal internal temperature
Reduced magnetic field strength

**List of Functions**

Function	Teach pad setting	IO-Link setting
Measurement range change	●	●
Measurement range reset	●	●
Analog output mode change	●	●
Reverse analog output	●	●
Single-point mode setting	●	●
Auto switch mode setting	●	●
Window mode setting	●	●
2-point mode setting	×	●
Switch point reset	●	●
Reverse switch output	●	●
Hysteresis setting	×	●



# Actuator Position Sensor

## D-MP Series



### Specifications

Model		D-MP025	D-MP050	D-MP100	D-MP200
<b>Measuring range</b>		25 mm ±1 mm	50 mm ±1 mm	100 mm ±1 mm	200 mm ±1 mm
<b>Power supply voltage</b>		15 to 30 VDC, Ripple (p-p) 10% or less (with power supply polarity protection)			
<b>Current consumption</b>		48 mA or less (when no load is applied)			
<b>Repeatability</b> *1, *2		0.1 mm (Ambient temperature: 25°C)			
<b>Resolution</b>		0.05 mm			
<b>Linearity</b> *2		±0.3 mm (Ambient temperature: 25°C)			
<b>Switch output</b>		NPN or PNP 1 output (push-pull)			
<b>Maximum load current</b>		40 mA			
<b>Internal voltage drop</b>		2 V or less			
<b>Leakage current</b>		NPN: 0.5 mA or less at load resistance 3 kΩ, 1.5 mA or less at load resistance 750 Ω PNP: 0.1 mA or less			
<b>Short-circuit protection</b>		Yes			
<b>Analog current output</b> *3	Output current	4 to 20 mA			
	Maximum load resistance	500 Ω			
<b>Analog voltage output</b> *3	Output voltage	0 to 10 V			
	Minimum load resistance	2 kΩ			
<b>Lead wire</b>		PUR 4 cores ø2.6 0.08 mm <sup>2</sup>			
<b>Standards</b>		CE marking (EMC directive/RoHS directive), UL			
<b>Impact resistance</b>		300 m/s <sup>2</sup>			
<b>Insulation resistance</b>		50 MΩ or more (500 VDC measured via megohmmeter)			
<b>Withstand voltage</b>		1000 VAC for 1 minute			
<b>Ambient temperature</b>		-10 to 60°C			
<b>Enclosure</b>		IEC60529 Standard IP67			
<b>IO-Link</b>	Version	V1.1			
	Communication speed	COM3 (230.4 kbps)			
	Process data size	Input: 2 bytes, Output: 0 byte			
	Minimum cycle time	1 ms			
	Device ID	125 hex	126 hex	127 hex	128 hex
	Vendor ID	83 hex			

\*1 Repeatability of magnetic movement in one direction

\*2 Refer to the Specific Product Precautions (pages 9 and 10).

\*3 Switching between analog voltage/current can be set.

### Lead Wire Specifications

Model		D-MP
<b>Sheath</b>	Outside diameter [mm]	ø2.6
<b>Insulator</b>	Number of cores	4 (Brown/Blue/Black/White)
	Outside diameter [mm]	ø0.57
<b>Conductor</b>	Effective area [mm <sup>2</sup> ]	0.08
<b>Minimum bending radius [mm] (Reference values)</b>		13

### Weight

Model		D-MP025	D-MP050	D-MP100	D-MP200
<b>Lead wire length</b>	2 m (A)	29	31	37	51
	0.3 m (B)	17	19	25	39
	0.3 m (C)	25	27	33	47

### How to Order

**D-MP 025 A**

#### Measuring range

Symbol	Specifications
<b>025</b>	25 mm
<b>050</b>	50 mm
<b>100</b>	100 mm
<b>200</b>	200 mm

#### Lead wire

Symbol	Specifications
<b>A</b>	Separate line, 2.0 m
<b>B</b>	M8-4 pin, 0.3 m
<b>C</b>	M12-4 pin, 0.3 m

# D-MP□ Series

## Internal Circuits and Wiring Examples

### SIO mode

#### NPN output

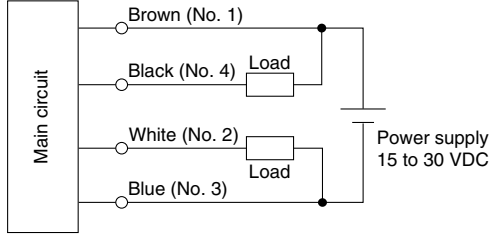

#### PNP output

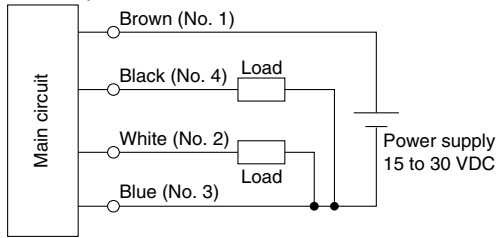

### IO-Link mode

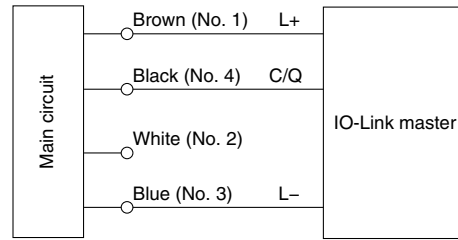

Connector pin numbers are shown in parentheses.

Analog output (white) is disabled when the IO-Link mode is selected.

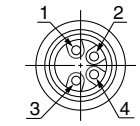

M8 connector pin assignment

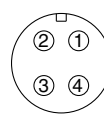

M12 connector pin assignment

Wiring		Meaning
Connector pin number	Wiring color	
1	Brown	Power supply DC(+)
2	White	Analog current output/ Analog voltage output
3	Blue	Power supply DC(-)
4	Black	IO-Link/Switch output

## Dimensions

### D-MP□A

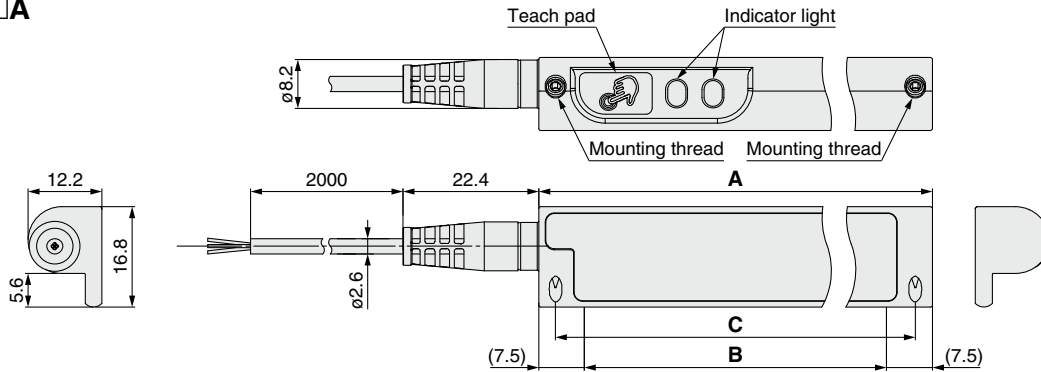

[mm]

Model	A	B	C
		Detectable range	
D-MP025□	40.5	25	35.0
D-MP050□	64.9	50	59.3
D-MP100□	114.9	100	109.3
D-MP200□	214.7	200	209.1

### D-MP□B

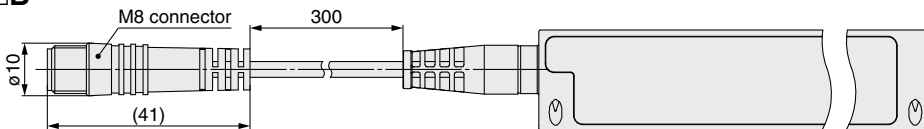



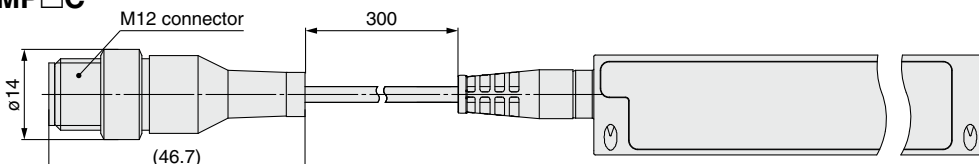







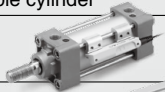









### D-MP□C



# Actuator Position Sensor Mounting

## Applicable Actuators

The actuator position sensor cannot be ordered with the cylinder model number. It must be ordered separately. Refer to page 4 for how to order the actuator position sensor.

Applicable cylinder	Series	6	8	10	12	15	16	20	25	32	40	50	63	80	100	125
Air Cylinder 	MB									●	●	●	●	●	●	●
Compact Cylinder/Compact Type 	CQS				●		●	●	●							
Compact Cylinder 	CQ2				●		●	●	●	●	●	●	●	●		
Compact Cylinder/Plate Type 	CQU							●	●	●	●					
Compact Slide 	MXH	●		●			●	●								
Air Slide Table 	MXS*3	●	●		●		●	●	●							
Air Slide Table 	MXQ*3	●	●		●		●	●	●							
Air Slide Table 	MXQA*3	●	●		●		●	●	●							
Air Slide Table 	MXQB*3	●	●		●		●	●								
Air Slide Table 	MXQC*3		●		●											
Air Slide Table 	MXQ*3 (Height interchangeable type)	●	●		●		●	●	●							
Compact Guide Cylinder 	MGP				●		●	●	●	●	●	●	●	●		
Dual Rod Cylinder 	CXSJ	●*2		●		●		●	●	●						
Parallel Type Air Gripper 	MHZ2*4							●	●	●	●	●				
Parallel Type Air Gripper/ Long Stroke Type 	MHZL2*4							●	●	●						
Low-profile Air Gripper 	MHF2-X7050*4		●		●		●	●								
Wide Type Parallel Style Air Gripper 	MHL2-Z*4			●			●	●	●	●	●					
ISO Cylinder (ISO standard) 	CP96-X3031*1									●	●	●	●	●	●	
ISO Cylinder (ISO standard) 	C96									●	●	●	●	●	●	●
Compact Cylinder (ISO standard) 	C55								●	●	●	●	●	●		

\*1 The mounting position differs when mounted on a CP96 series ISO cylinder (ISO Standards compliant). For more information, refer to the CP96 mounting specifications on page 8.

\*2 Can only be used with the CXSJM

\*3 For slide tables

① When a buffer mechanism is provided, the table may not be able to follow the piston rod depending on the load and speed. Depending on the operating conditions, etc., a delay of about 10 ms may occur.

② When the standard body option is selected, use the symmetrical type (L type) for the following models or the position sensor may protrude from the mounting surface (body bottom surface).  
MXS (ø6, ø8), MXQ (ø6, ø8), MXQB (ø6, ø8), MXQC (ø8), and MXQ Height interchangeable type (ø6, ø8)

③ The MXQA (ø6 and ø8) can only be mounted on the axial piping type.

\*4 For air grippers

① Due to the construction, the linearity specifications may not be satisfied. Please contact SMC for more information.

② The ø6 and the ø10 of the MHZ2 and the ø10 of the MHZL2 cannot be used because the mounting dimensions are too short.

③ When the sensor is mounted to the MHF2 series, the cylinder model number will be different from the standard type.

For more information, refer to the MHF2 mounting specifications on page 8.

Example) MXQ6

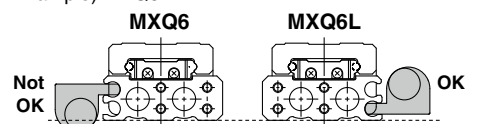

## Mounting

### Direct Mount Type

Applicable cylinder	Series
Compact Cylinder/Compact Type	<b>CQS</b>
Compact Cylinder	<b>CQ2</b>
Compact Cylinder/Plate Type	<b>CQU</b>
Compact Slide	<b>MXH</b>
Air Slide Table	<b>MXS</b>
Air Slide Table	<b>MXQ</b>
Air Slide Table	<b>MXQA</b>
Air Slide Table	<b>MXQB</b>
Air Slide Table	<b>MXQC</b>
Air Slide Table	<b>MXQ</b> (Height interchangeable type)
Compact Guide Cylinder	<b>MGP</b>
Dual Rod Cylinder	<b>CXSJ</b>
Parallel Type Air Gripper	<b>MHZ2</b>
Parallel Type Air Gripper/Long Stroke Type	<b>MHZL2</b>
Low Profile Air Gripper	<b>MHF2</b>
Wide Type Parallel Style Air Gripper	<b>MHL2</b>
ISO Cylinder (ISO standard)	<b>CP96</b>
Compact Cylinder (ISO standard)	<b>C55</b>

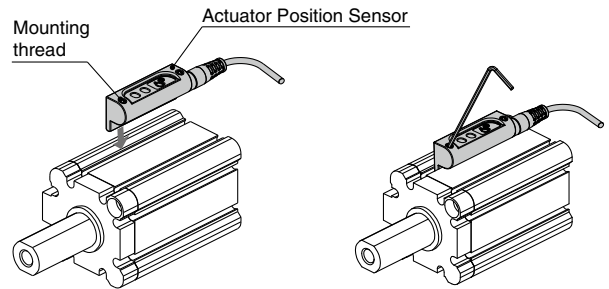

- \* When tightening mounting screws, use a suitable hexagon wrench (1.5). The tightening torque should be 0.2 to 0.4 N·m.
- \* Tighten the mounting screws evenly.

### Tie-rod Mounting Type

Applicable cylinder	Series
Air Cylinder	<b>MB</b>
ISO Cylinder (ISO standard)	<b>C96</b>

### How to Mount and Move the Actuator Position Sensor

1. Fit the mounting bracket to the tie rod, and ensure that the bottom of the mounting bracket is in firm contact with the cylinder tube. As there are two mounting screws for the actuator position sensor, two mounting brackets should be used for 1 actuator position sensor.
2. Fix it to the detecting position with a set screw (M4).\*1 (Use a hexagon wrench.)
3. Insert the actuator position sensor into the mounting groove of the mounting bracket and set it at approximately the set position.
4. Once the detection position is confirmed, tighten the mounting screws provided to fix the actuator position sensor.\*2
5. When changing the detecting position, carry out in the state of ③.

\*1 Set the tightening torque of a hexagon socket head set screw (M4) to be 1 to 1.2 N·m.

\*2 Tightening torque for mounting thread should be 0.2 to 0.4 N·m.

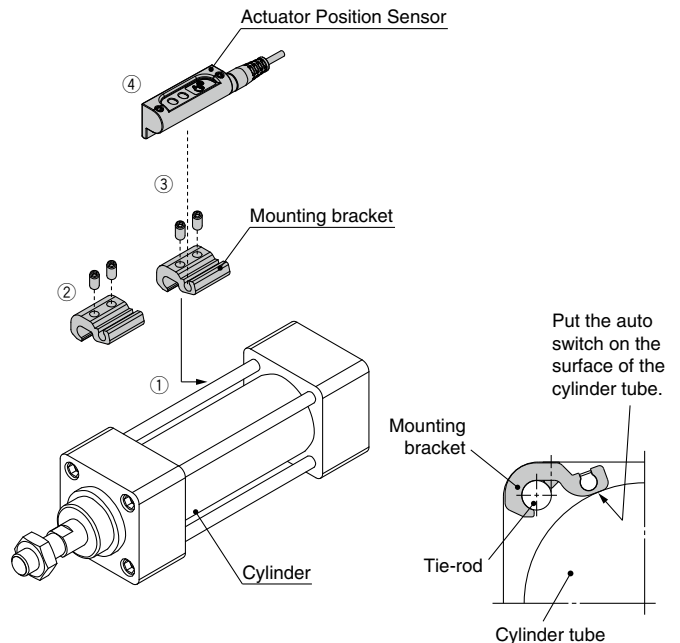

### Mounting Bracket Part No. (Order separately)

Cylinder Series	Applicable bore size [mm]						
	32	40	50	63	80	100	125
<b>MB, C96</b>	BMB5-032	BMB5-032	BA7-040	BA7-040	BA7-063	BA7-063	BA7-080

\* Two mounting brackets are required for each actuator position sensor. Therefore specify "2" when ordering.



## Mounting Specifications/CP96 Series

### How to Order

Standard model no.	- X3031
--------------------	---------

● Change in the actuator position sensor mounting groove position specification

### Cylinder Specifications

Actuator position sensor mounting groove	Change in the cylinder tube mounting groove position
Specifications other than the above	Same as those of the standard type

Cylinder dimensions: Same as those of the standard type

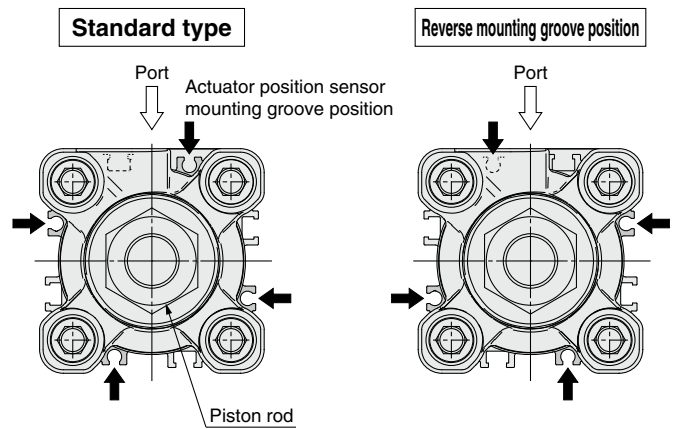

The mounting groove is reversed so that the actuator position sensor lead wire is not in line with the piston rod.

## Mounting Specifications/MHF2 Series

### How to Order

Standard model no.	- X7050
--------------------	---------

● Single magnet on each side of the piston specification

### Stroke

Stroke	Bore size			
	ø8	ø12	ø10	ø20
Short stroke	—	●	●	●
Medium stroke	●	●	●	●
Long stroke	●	●	●	●

\* A short stroke cannot be used for the ø8 because the mounting dimension is too short.

### Air Gripper Specifications

Stroke	See above.
Magnet	Single magnet on each side of the piston (2 in total)
Specifications other than the above	Same as those of the standard type

Air gripper dimensions: Same as those of the standard type



## D-MP□ Series

# Actuator Position Sensor/Specific Product Precautions 1

Be sure to read this before handling the products. Refer to the back cover for safety instructions. For actuator and auto switch precautions, refer to the “Handling Precautions for SMC Products” and the “Operation Manual” on the SMC website: <https://www.smcworld.com>

### Design and Selection

#### Caution

##### 1. Take precautions when multiple cylinders/actuators are used close together.

When multiple built-in magnet cylinders/actuators are used in close proximity, magnetic field interference may cause the actuator position sensors to malfunction. Maintain a minimum cylinder separation of 40 mm. (When the allowable interval is specified for each cylinder series, use the indicated value.)

The accuracy of the actuator position sensor might be reduced and a malfunction may occur due to magnetic field interference.

##### 2. Detectable position limitations

There are positions and surfaces (bottom surface of the foot bracket, etc.) where the actuator position sensor cannot be mounted due to physical interference from the cylinder/actuator mounting position or mounting brackets.

Select an appropriate mounting position where the actuator position sensor does not interfere with the cylinder/actuator mounting brackets (trunnion or reinforcing ring) or fittings after a thorough check.

Depending on the cylinder bore size and stroke, the actuator position sensor might protrude from the cylinder and mounting may not be possible.

When the position is to be measured over the full stroke of the cylinder, use a cylinder with a stroke 5 mm shorter than the sensor range.

Use a stroke reading cylinder when the full stroke cannot be detected by the actuator position sensor.

##### 3. The wiring length should be kept to 20 m or less.

When long wires are required, we recommend attaching ferrite cores to both ends of the cable to prevent excess noise.

##### 4. Output operation of the actuator position sensor is not stable for 150 [ms] after being powered ON.

In the output operation immediately after being powered ON, the input device (PLC, relay, etc.) may judge the ON position as OFF output or the OFF position as ON output.

Please set the equipment so that the input judgement signal is disabled for 150 [ms] immediately after being powered ON.

##### 5. Install a rotation stopper to the actuator piston rod.

Use a guide or select an SMC product with a rotation-stopping function.

The accuracy may decrease without a rotation stopper.

With some cylinders, the magnet may rotate even when the piston rod does not rotate. The magnet inside some cylinders with a guide may rotate. Please contact SMC for details.

##### 6. If power is supplied outside of the measurement range, the analog output will indicate the lower limit value.

(The analog current is 4 [mA], the analog voltage is 0 [V], and the switch output is ON for NPN output and OFF for PNP output.)

Analog output and switch output will operate properly after operating the cylinder at full stroke more than once.

### Design and Selection

#### Caution

##### 7. Accuracy may decrease under the following operating conditions.

Accuracy may decrease when the warm-up time is inadequate (10 – 15 mins), when there is play (due to mechanical factors, floating joints, etc.), or when the operating environment contains magnetic parts (iron screws) or other magnetic disturbances that may affect the product.

It is recommended that non-magnetic materials be used for surrounding parts.

### Mounting/Adjustment

#### Caution

##### 1. Do not drop or bump.

Do not drop, bump, or apply excessive impact (300 m/s<sup>2</sup> or more) while handling the actuator position sensor. Doing so may cause the actuator position sensor to break or malfunction.

##### 2. Be sure to tighten within the recommended tightening torque when mounting the actuator position sensor.

When an actuator position sensor is tightened beyond the recommended tightening torque range (0.2 to 0.4 N·m), the cylinder/actuator body, mounting screws, mounting brackets, or the actuator position sensor body itself may be damaged.

On the other hand, tightening below the range may allow the actuator position sensor to slip out of position.

##### 3. Check the actual actuation status and adjust the actuator position sensor mounting position accordingly.

According to the installation environment, the cylinder/actuator may not operate even when mounted appropriately.

Even when set at the middle of the stroke, check the actuation status and make adjustments accordingly.

If it does not work properly, it may be improved by restarting the power supply or operating the piston for several strokes.



## D-MP□ Series

# Actuator Position Sensor/Specific Product Precautions 2

Be sure to read this before handling the products. Refer to the back cover for safety instructions. For actuator and auto switch precautions, refer to the “Handling Precautions for SMC Products” and the “Operation Manual” on the SMC website: <https://www.smcworld.com>

### Operating Environment

#### Warning

**1. Never use in atmospheres containing explosive gases.**

Actuator position sensors are not designed to be explosion proof. Therefore, the product may be an explosion hazard.

#### Caution

**1. Do not use in areas where magnetic fields are generated.**

The actuator position sensor will malfunction or its accuracy will be decreased.

**2. Do not use in environments where the actuator position sensor will be continually exposed to water or condensation.**

Although actuator position sensors satisfy IEC Standard IP construction, do not use actuator position sensors in applications where they will be continually exposed to water splash or spray. Doing so may result in a malfunction or insulation problems.

**3. Do not use in environments where oil or chemicals are present.**

If actuator position sensors are used in environments containing coolant, cleaning solvent, oils, or chemicals, even for a short period of time, they may be adversely affected, resulting in improper insulation, malfunction due to the swelling of potting resin, or the hardening of lead wires.

**4. Do not use the product in welding environments.**

The actuator position sensor will malfunction or its accuracy will be decreased.

### Maintenance

#### Warning

**1. Perform the following maintenance and inspection periodically in order to prevent possible dangers due to unexpected actuator position sensor malfunction.**

1) Secure and tighten the actuator position sensor mounting screws.

If the screws become loose or the product is out of position, retighten them after readjusting the mounting position.

2) Confirm that there is no damage to the lead wires.

To prevent faulty insulation, replace actuator position sensors or repair lead wires if damage is discovered.

3) The analog output of the position sensor may fluctuate due to wear or the deformation of air gripper fingers or jigs when used long term. Periodic maintenance is recommended.

## Safety Instructions

These safety instructions are intended to prevent hazardous situations and/or equipment damage. These instructions indicate the level of potential hazard with the labels of “**Caution**,” “**Warning**” or “**Danger**.” They are all important notes for safety and must be followed in addition to International Standards (ISO/IEC)\*1), and other safety regulations.

 **Caution:** **Caution** indicates a hazard with a low level of risk which, if not avoided, could result in minor or moderate injury.

 **Warning:** **Warning** indicates a hazard with a medium level of risk which, if not avoided, could result in death or serious injury.

 **Danger :** **Danger** indicates a hazard with a high level of risk which, if not avoided, will result in death or serious injury.

\*1) ISO 4414: Pneumatic fluid power – General rules relating to systems.  
ISO 4413: Hydraulic fluid power – General rules relating to systems.  
IEC 60204-1: Safety of machinery – Electrical equipment of machines.  
(Part 1: General requirements)  
ISO 10218-1: Manipulating industrial robots – Safety.  
etc.

### Warning

#### 1. The compatibility of the product is the responsibility of the person who designs the equipment or decides its specifications.

Since the product specified here is used under various operating conditions, its compatibility with specific equipment must be decided by the person who designs the equipment or decides its specifications based on necessary analysis and test results. The expected performance and safety assurance of the equipment will be the responsibility of the person who has determined its compatibility with the product. This person should also continuously review all specifications of the product referring to its latest catalog information, with a view to giving due consideration to any possibility of equipment failure when configuring the equipment.

#### 2. Only personnel with appropriate training should operate machinery and equipment.

The product specified here may become unsafe if handled incorrectly. The assembly, operation and maintenance of machines or equipment including our products must be performed by an operator who is appropriately trained and experienced.

#### 3. Do not service or attempt to remove product and machinery/equipment until safety is confirmed.

1. The inspection and maintenance of machinery/equipment should only be performed after measures to prevent falling or runaway of the driven objects have been confirmed.
2. When the product is to be removed, confirm that the safety measures as mentioned above are implemented and the power from any appropriate source is cut, and read and understand the specific product precautions of all relevant products carefully.
3. Before machinery/equipment is restarted, take measures to prevent unexpected operation and malfunction.

#### 4. Contact SMC beforehand and take special consideration of safety measures if the product is to be used in any of the following conditions.

1. Conditions and environments outside of the given specifications, or use outdoors or in a place exposed to direct sunlight.
2. Installation on equipment in conjunction with atomic energy, railways, air navigation, space, shipping, vehicles, military, medical treatment, combustion and recreation, or equipment in contact with food and beverages, emergency stop circuits, clutch and brake circuits in press applications, safety equipment or other applications unsuitable for the standard specifications described in the product catalog.
3. An application which could have negative effects on people, property, or animals requiring special safety analysis.
4. Use in an interlock circuit, which requires the provision of double interlock for possible failure by using a mechanical protective function, and periodical checks to confirm proper operation.

### Caution

#### 1. The product is provided for use in manufacturing industries.

The product herein described is basically provided for peaceful use in manufacturing industries.  
If considering using the product in other industries, consult SMC beforehand and exchange specifications or a contract if necessary.  
If anything is unclear, contact your nearest sales branch.

### Limited warranty and Disclaimer/ Compliance Requirements

The product used is subject to the following “Limited warranty and Disclaimer” and “Compliance Requirements”.

Read and accept them before using the product.

#### Limited warranty and Disclaimer

1. The warranty period of the product is 1 year in service or 1.5 years after the product is delivered, whichever is first.\*2)  
Also, the product may have specified durability, running distance or replacement parts. Please consult your nearest sales branch.
2. For any failure or damage reported within the warranty period which is clearly our responsibility, a replacement product or necessary parts will be provided.  
This limited warranty applies only to our product independently, and not to any other damage incurred due to the failure of the product.
3. Prior to using SMC products, please read and understand the warranty terms and disclaimers noted in the specified catalog for the particular products.

##### \*2) Vacuum pads are excluded from this 1 year warranty.

A vacuum pad is a consumable part, so it is warranted for a year after it is delivered.  
Also, even within the warranty period, the wear of a product due to the use of the vacuum pad or failure due to the deterioration of rubber material are not covered by the limited warranty.

#### Compliance Requirements

1. The use of SMC products with production equipment for the manufacture of weapons of mass destruction (WMD) or any other weapon is strictly prohibited.
2. The exports of SMC products or technology from one country to another are governed by the relevant security laws and regulations of the countries involved in the transaction. Prior to the shipment of a SMC product to another country, assure that all local rules governing that export are known and followed.

### Caution

#### SMC products are not intended for use as instruments for legal metrology.

Measurement instruments that SMC manufactures or sells have not been qualified by type approval tests relevant to the metrology (measurement) laws of each country. Therefore, SMC products cannot be used for business or certification ordained by the metrology (measurement) laws of each country.

#### Revision History

**Edition B** \* Now with a greater number of models!  
\* The CQS, CQU, MXH, MXS, MXQ□, MHZ2, MHZL2, MHL2, and MHF2 series have been added.

ZS

## Safety Instructions

Be sure to read the “Handling Precautions for SMC Products” (M-E03-3) and “Operation Manual” before use.