

Direct Mount Type

REBR Series

ø15, ø25, ø32

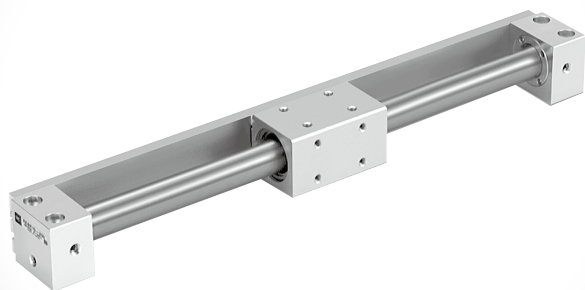

REA

REB

REC

Smooth

Low
Speed

MQ

RHC

RZQ

D-□

-X□

REBR Series Model Selection

F_n: Allowable driving force (N)
M_b: Maximum allowable moment when connection fitting, etc., is directly loaded (N·m)
P_v: Maximum operating pressure for vertical operation (MPa)
W_{max}: Maximum load mass when loaded directly on the body (kg)
W_v: Allowable load mass for vertical operation (kg)

Operating Conditions

- **W**: Load mass (kg)
- **W_b**: Connection fitting mass (kg)
- **μ**: Guide's coefficient of friction
- **L_o**: Distance from cylinder shaft center to workpiece point of application (cm)
- **L₁**: Distance from the cylinder shaft center to the center of the gravity of connection fitting, etc. (mm)
- Presence of switches
- **P**: Operating pressure (MPa)
- **U**: Maximum speed (mm/s)
- Stroke (mm)
- Mode of operation (horizontal, inclined, vertical)

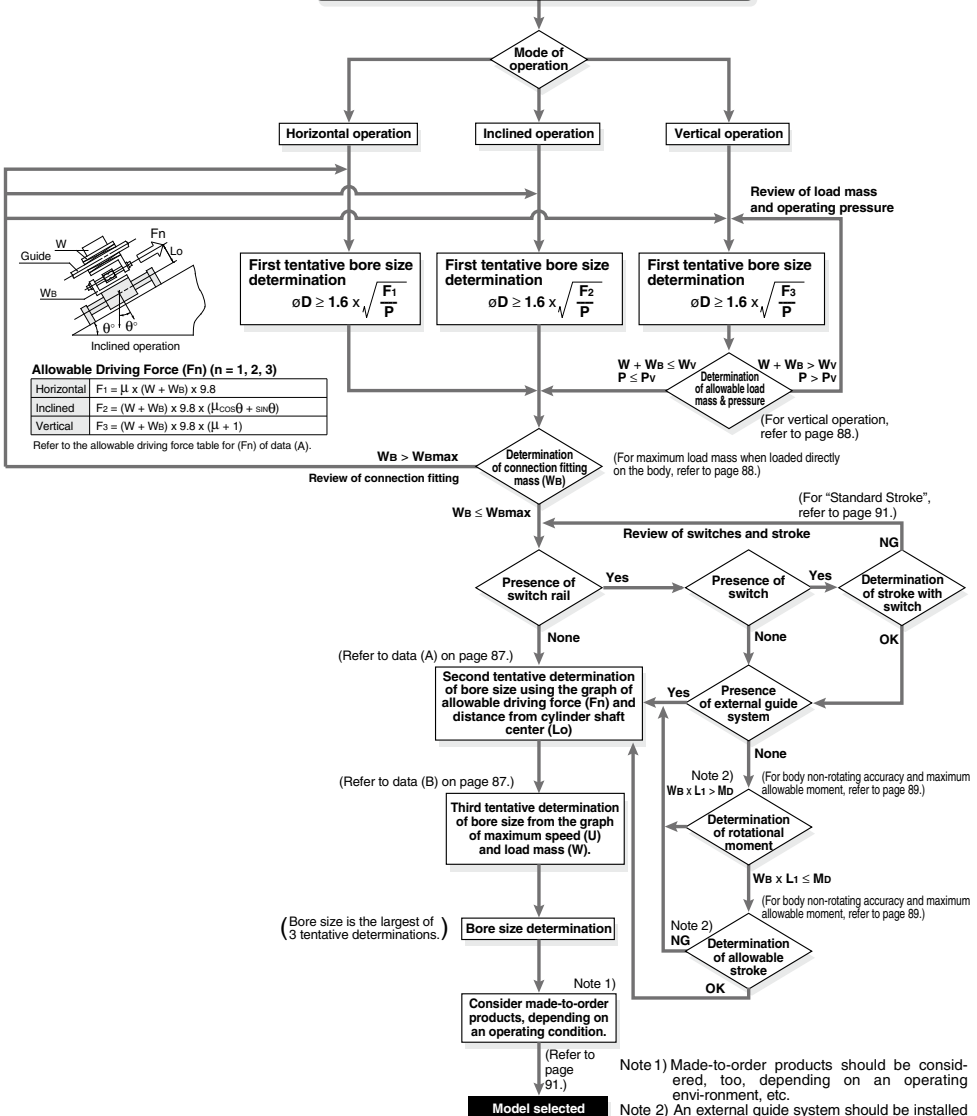

Note 1) Made-to-order products should be considered, too, depending on an operating environment, etc.
 Note 2) An external guide system should be installed when it is used beyond specifications.

Caution on Design 1

Selection Method

<Data (A): Distance from Cylinder Shaft Center — Allowable Driving Capacity>

Selection Procedures

- ① Find the drive resisting force F_n (N) when moving the load horizontally.
- ② Find the distance L_o (cm) from the point of the load where driving force is applied, to the center of the cylinder shaft.
- ③ Select a bore size from L_o and F_n in Data A.

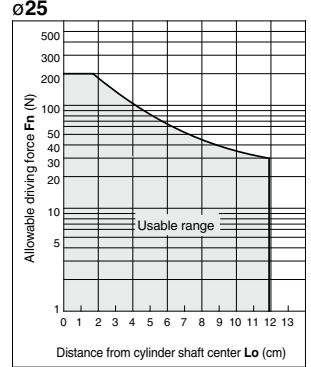
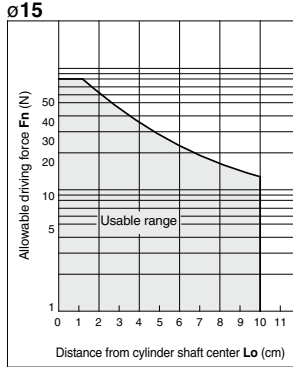
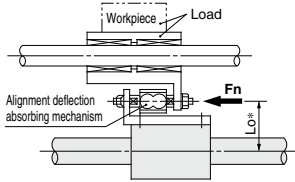

Selection Example

Given a load drive resisting force of $F_n = 100$ (N) and a distance from the cylinder shaft center to the load application point of $L_o = 8$ cm, find the intersection point by extending upward from the horizontal axis of data (A) where the distance from the shaft center is 8 cm, and then extending to the side, find the allowable driving force on the vertical axis. Models suitable to satisfy the requirement of 100 (N) are **REBR32**.

* Distance from cylinder shaft center, L_o , is the moment working point between the cylinder and the load.

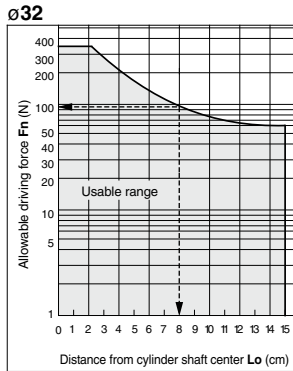

<Data (B): Maximum Speed — Load mass Chart>

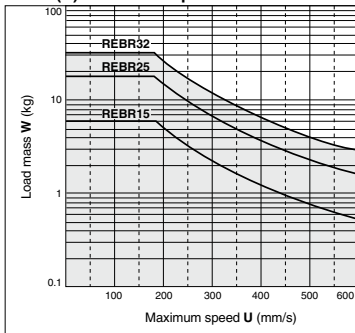

- REA
- REB
- REC
- Smooth
- Low Speed
- MQ
- RHC
- RZQ

- D-□
- X□

Caution on Design 2

Cylinder Self-weight Deflection

When the cylinder is mounted horizontally, deflection appears due to its own weight as shown in the data, and the longer the stroke, the greater the amount of variation in the shaft centers. Therefore, a connection method should be considered which allows for this variation as shown in the drawing.

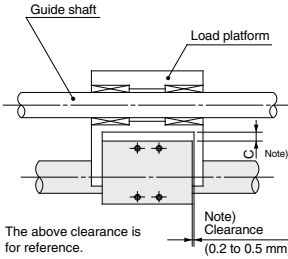

Note) Referring to the self-weight deflection in the graph below, provide clearance so that the cylinder does not touch the mounting surface or the load section, and is able to operate smoothly within the minimum operating pressure range for a full stroke.

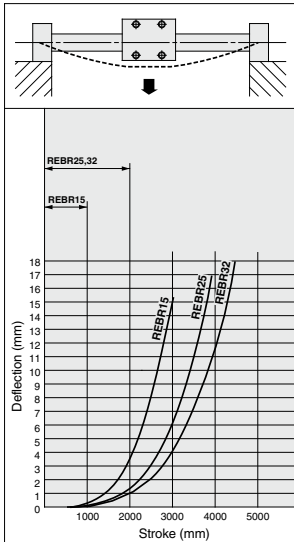

* The above deflection data indicate values when the external slider has moved to the middle of the stroke.

Vertical Operation

The load should be guided by a ball type bearing (LM guide, etc.). If a slide bearing is used, sliding resistance will increase due to the load mass and moment, and this can cause malfunction.

When the cylinder is mounted vertically or sidelong, sliders may move downwards due to the self-weight or workpiece mass. If an accurate stopping position is required at the stroke end or the middle-stroke, use an external stopper to secure accurate positioning.

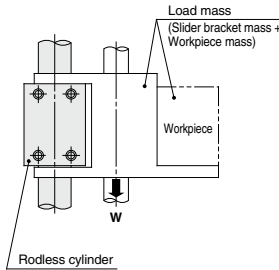

Bore size (mm)	Model	Allowable load mass W_v (kg)	Maximum operating pressure P_v (MPa)
15	REBR15	7.0	0.65
25	REBR25	18.5	0.65
32	REBR32	30.0	0.65

Note) Use caution, since the magnetic coupling may be dislocated if it is used over the maximum operating pressure.

Maximum Load Mass when Loaded Directly on Body

When the load is applied directly to the body, it should be no greater than the maximum values shown in the table below.

Model	Maximum load mass W_{max} (kg)
REBR15	1.0
REBR25	1.2
REBR32	1.5

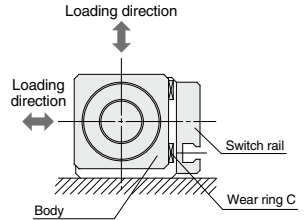

Caution on Design 3

Body Non-rotating Accuracy and Max. Allowable Moment (With switch rail) (Reference values)

Intermediate Stop

The cushion effect (smooth start-up, soft stop) exists only before the stroke end in the stroke ranges indicated in the table below.

The cushion effect (smooth start-up, soft stop) cannot be obtained in an intermediate stop or return from an intermediate stop using an external stopper, etc.

Cushion Stroke

Model	Stroke (mm)
REBR15	25
REBR25	30
REBR32	30

Reference values for non-rotating accuracy and maximum allowable moment at stroke end are indicated below.

Bore size (mm)	Non-rotating accuracy (°)	Maximum allowable moment M _a (N·m)	Note 2) Allowable stroke (mm)
15	4.5	0.15	200
25	3.7	0.25	300
32	3.1	0.40	400

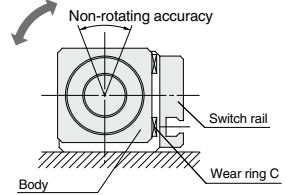

Note 1) Avoid operations where rotational torque (moment) is applied. In such a case, the use of an external guide is recommended.

Note 2) The above reference values will be satisfied within the allowable stroke ranges. However, caution is necessary because as the stroke becomes longer the inclination (rotation angle) within the stroke can be expected to increase.

Note 3) When a load is applied directly to the body, the loaded mass should be no greater than the allowable load mass on page 88.

- REA
- REB
- REC
- Smooth
- Low Speed
- MQ
- RHC
- RZQ

- D-□
- X□

Sine Rodless Cylinder / Direct Mount Type

REBR Series

ø15, ø25, ø32

How to Order

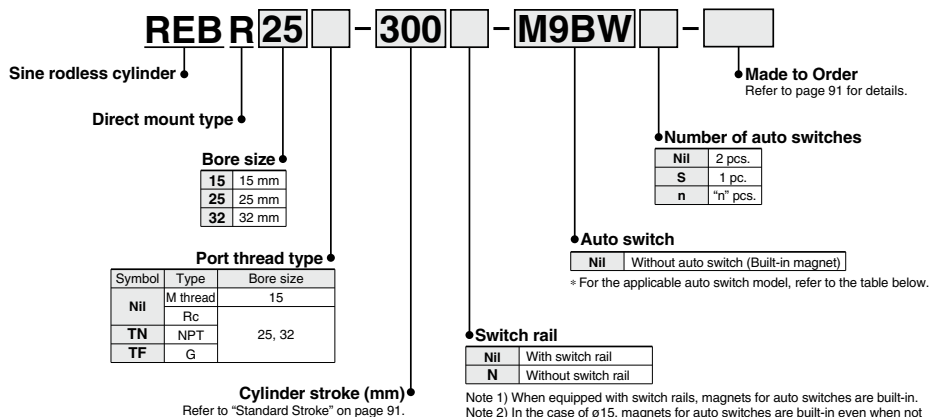

Applicable Auto Switches

Refer to pages 941 to 1067 for further information on auto switches.

Type	Special function	Electrical entry	Indicator light	Wiring (Output)	Load voltage		Auto switch model	Lead wire length (m)				Pre-wired connector	Applicable load	
					DC	AC		0.5 (Nil)	1 (M)	3 (L)	5 (Z)			
Solid state auto switch	—	Grommet	Yes	3-wire (NPN)	24 V	5 V, 12 V	—	M9N	●	●	○	○	IC circuit	Relay, PLC
				3-wire (PNP)				M9P	●	●	○	○		
				2-wire				M9B	●	●	○	○		
	3-wire (NPN)			5 V, 12 V	M9NW	●		●	○	○	IC circuit			
	3-wire (PNP)				M9PW	●		●	○	○				
	2-wire				M9BW	●		●	○	○				
	Water resistant (2-color indicator)	Grommet	No	3-wire (NPN)	24 V	5 V, 12 V		M9NA*1	○	○	○	○	IC circuit	
				3-wire (PNP)				M9PA*1	○	○	●	○		
				2-wire				M9BA*1	○	○	●	○		
Reed auto switch	—	Grommet	No	3-wire (NPN equivalent)	24 V	5 V	A96	●	—	—	—	IC circuit	—	
				2-wire			100 V	A93	●	●	●	—		—
					100 V or less		A90	●	—	—	—	IC circuit		

*1 Water resistant type auto switches can be mounted on the above models, but in such case SMC cannot guarantee water resistance. Consult with SMC regarding water resistant types with the above model numbers.

* Lead wire length symbols: 0.5 m..... Nil (Example) M9NW
 1 m..... M (Example) M9NWM
 3 m..... L (Example) M9NWL
 5 m..... Z (Example) M9NWLZ

* Solid state auto switches marked with "○" are produced upon receipt of order.

* Since there are other applicable auto switches than listed, refer to page 94 for details.
 * For details about auto switches with pre-wired connector, refer to pages 1014 and 1015.
 * Auto switches are shipped together (not assembled).

Sine Rodless Cylinder Direct Mount Type **REBR Series**

Specifications



Symbol

Air cushion
(Magnet type)

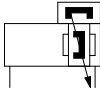

Made to Order Specifications
[Click here for details](#)

Symbol	Specifications
-XC57	With Floating Joint

Bore size (mm)	10	15	32
Fluid	Air		
Proof pressure	1.05 MPa		
Maximum operating pressure	0.7 MPa		
Minimum operating pressure	0.18 MPa		
Ambient and fluid temperature	-10 to 60°C (No freezing)		
Piston speed (Max.) ^(Note)	50 to 600 mm/s		
Lubrication	Not required (Non-lube)		
Stroke length tolerance (mm)	0 to 250 st: $^{+1.0}_0$, 251 to 1000 st: $^{+1.4}_0$, 1001 st and up to: $^{+1.8}_0$		
Handling force (N)	137	363	588

Note) Piston speed above indicates the maximum speed. It takes approximately 0.5 seconds (for one side) after the body moves from the stroke end until it goes through the cushion stroke, while it takes approximately 1 second for both sides.

Standard Stroke

Bore size (mm)	Standard stroke (mm)	Maximum manufacturable stroke (mm)	Maximum stroke with switch (mm)
15	150, 200, 250, 300, 350, 400, 450, 500	1000	750
25	200, 250, 300, 350, 400, 450	2000	1500
32	500, 600, 700, 800		

Note) Intermediate stroke is available in 1 mm increments.

Weight

Item	Bore size (mm)	(kg)		
		15	25	32
Basic weight (for 0 st)	REBR□ (with switch rail)	0.277	0.660	1.27
	REBR□-□N (without switch rail)	0.230	0.580	1.15
Additional weight per each 50 mm of stroke (when equipped with switch rail)		0.045	0.083	0.113
Additional weight per each 50 mm of stroke (when not equipped with switch rail)		0.020	0.050	0.070

Calculation: (Example) REBR25-500 (with switch rail)

- Basic weight 0.660 (kg)
- Additional weight 0.083 (kg/50 st)
- Cylinder stroke 500 (st)
- 0.660 + 0.083 x 500 + 50 = 1.49 kg

REA

REB

REC

Smooth

Low Speed

MQ

RHC

RZQ

D-□

-X□

REBR Series

Construction: $\varnothing 15, \varnothing 25, \varnothing 32$

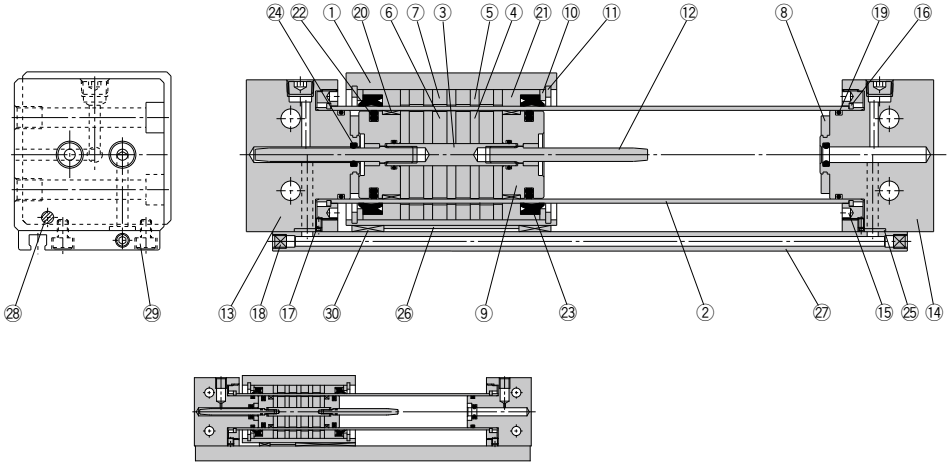

REBR15

Component Parts

No.	Description	Material	Note
1	Body	Aluminum alloy	Hard anodized
2	Cylinder tube	Stainless steel	
3	Shaft	Stainless steel	
4	Piston side yoke	Roller steel plate	Zinc chromated
5	External slider side yoke	Roller steel plate	Zinc chromated
6	Magnet A	—	
7	Magnet B	—	
8	Bumper	Urethane rubber	Except REBR15
9	Piston	Aluminum alloy	Chromated
10	Spacer	Roller steel plate	Nickel plated
11	Retaining ring	Carbon tool steel	Phosphate coated
12	Cushion ring	Stainless steel	REBR15, 25
		Brass	REBR32
13	End cover A	Aluminum alloy	Hard anodized
14	End cover B	Aluminum alloy	Hard anodized
15	Attachment ring	Aluminum alloy	Hard anodized
16	Type C retaining ring for axis	Hard steel wire material	Nickel plated (REBR15)
		Stainless steel	REBR25, 32
17	Hexagon socket head set screw	Chromium steel	Nickel plated
18	Hexagon socket head plug	Chromium steel	Nickel plated
19	Cylinder tube gasket	NBR	

Component Parts

No.	Description	Material	Note
20	Wear ring A	Special resin	
21	Wear ring B	Special resin	
22	Piston seal	NBR	
23	Scraper	NBR	
24	Cushion seal	NBR	
25	Switch rail gasket	NBR	
26	Magnetic shielding plate	Roller steel plate/Chromated	
27	Switch rail	Aluminum alloy/Clear anodized	
28	Magnet	—	
29	Hexagon socket head cap screw	Chromium steel/Nickel plated	
30	Wear ring C	Special resin	

Replacement Parts: Seal Kit

Bore size (mm)	Kit no.	Contents
15	REBR15-PS	A set of 19, 20, 21, 22, 23, 24, 25, 30 listed above
25	REBR25-PS	
32	REBR32-PS	

Note) Cushion seal 24 may be difficult to be replaced.

* Seal kit includes a grease pack (10 g).

Order with the following part number when only the grease pack is needed.

Grease pack part no.: GR-S-010 (10 g)

Switch Rail Accessory Kit

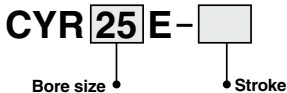

Switch Rail Accessory Kit

Bore size (mm)	Kit no.	Contents
15	CYR15E-□	Above nos. 26, 27, 28, 29, 30
25	CYR25E-□	
32	CYR32E-□	

Note 1) □ indicates the stroke.

Note 2) $\varnothing 15$ has internal magnets in the body.

Sine Rodless Cylinder Direct Mount Type **REBR Series**

Dimensions: $\varnothing 15, \varnothing 25, \varnothing 32$

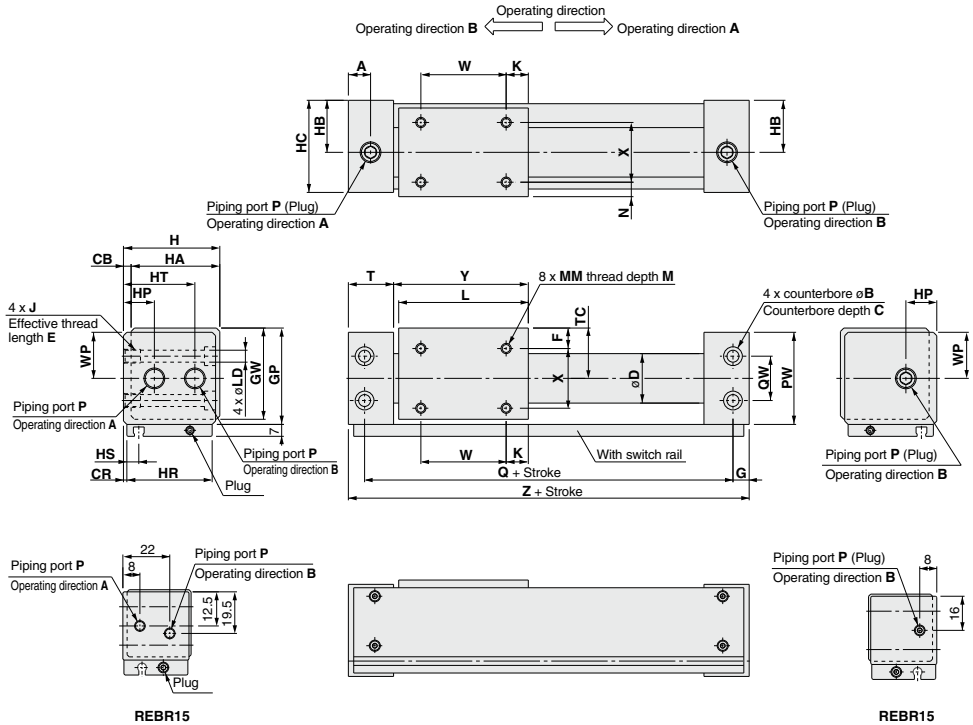

- REA
- REB**
- REC
- Smooth
- Low Speed
- MQ
- RHC
- RZQ

REBR15

REBR15

Model	A	B	C	CB	CR	D	F	G	GP	GW	H	HA	HB	HC	HP	HR	HS	HT
REBR15	12	8	4.2	2	0.5	17	8	7	33	31.5	32	30	17	31	—	30	8.5	—
REBR25	12.5	9.5	5.2	3	1	27.8	8.5	10	44	42.5	44	41	23.5	43	14.5	41	6.5	33.5
REBR32	19.5	11	6.5	3	1.5	35	10.5	16	55	53.5	55	52	29	54	20	51	7	39

Model	J x E	K	L	LD	M	MM	N	P	PW	Q	QW	T	TC	W	WP
REBR15	M5 x 0.8 x 7	14	53	4.3	5	M4 x 0.7	6	M5 x 0.8	32	84	18	21	17	25	—
REBR25	M6 x 1 x 8	15	70	5.6	6	M5 x 0.8	6.5	1/8	43	105	20	25.5	22.5	40	21.5
REBR32	M8 x 1.25 x 10	13	76	7	7	M6 x 1	8.5	1/8	54	116	26	33	28	50	27

Model	X	Y	Z
REBR15	18	54.5	98
REBR25	28	72	125
REBR32	35	79	148

- D-
- X

Auto Switch Mounting

Auto Switch Proper Mounting Position (Detection at Stroke End)

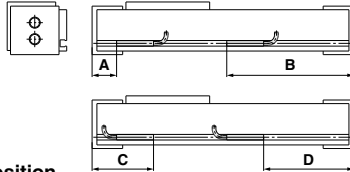

Auto Switch Proper Mounting Position ø15, ø25, ø32

Auto switch model Bore size	A		B		C		D	
	D-A9□	D-M9□ D-M9□W D-M9□A	D-A9□	D-M9□ D-M9□W D-M9□A	D-A9□	D-M9□ D-M9□W D-M9□A	D-A9□	D-M9□ D-M9□W D-M9□A
15	19.5	23.5	78.5	74.5	—	—	58.5	62.5
25	23	27	102	98	46	42	79	83
32	31.5	35.5	116.5	112.5	54.5	50.5	93.5	87.5

Note 1) Auto switches cannot be installed in Area C in the case of ø15.
Note 2) Adjust the auto switch after confirming the operating conditions in the actual setting.

ø25, ø32 (mm)

Auto switch model Bore size	A	B	C	D
	D-Z7□ D-Z80 D-Y59□ D-Y7P D-Y7□W D-Y7BA	D-Z7□ D-Z80 D-Y59□ D-Y7P D-Y7□W D-Y7BA	D-Z7□ D-Z80 D-Y59□ D-Y7P D-Y7□W D-Y7BA	D-Z7□ D-Z80 D-Y59□ D-Y7P D-Y7□W D-Y7BA
25	22	103	47	78
32	30.5	117.5	55.5	92.5

Note) Adjust the auto switch after confirming the operating conditions in the actual setting.

Operating Range

Auto switch model	Bore size (mm)		
	15	25	32
D-A9□	8	7.5	8
D-M9□W D-M9□ D-M9□A	4.5	5.5	4.5
D-Z7□/Z80	—	9	9
D-Y5□/Y7P/Y7□W/Y7BA	—	7	6

* Since this is a guideline including hysteresis, not meant to be guaranteed.
(assuming approximately ±30% dispersion)
There may be the case it will vary substantially depending on an ambient environment.

Auto Switch Specifications

Auto switch model	Bore size (mm)	
	ø25, ø32	
D-A9□ D-M9□ D-M9□W D-M9□A	BMG2-012	

D-A9□/M9□/M9□W/M9□A

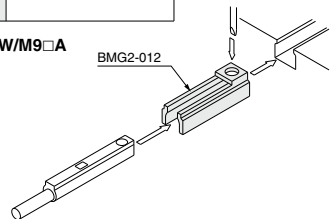

Other than the models listed in “How to Order”, the following auto switches are applicable.
For detailed specifications, refer to pages 941 to 1067.

Auto switch type	Model	Electrical entry (Fetching direction)	Features	Applicable bore size
Reed	D-Z73, Z76	Grommet (In-line)	—	ø25, ø32
	D-Z80		Without indicator light	
Solid state	D-Y59A, Y59B, Y7P	Grommet (In-line)	—	
	D-Y7NW, Y7PW, Y7BW		Diagnostic indication (2-color indicator)	
	D-Y7BA		Water resistant (2-color indicator)	

* For solid state auto switches, auto switches with a pre-wired connector are also available. Refer to pages 1014 and 1015 for details.
* Normally closed (NC = b contact) solid state auto switches (D-F9G/F9H/Y7G/Y7H types) are also available. Refer to pages 959 and 961 for details.



REBR Series Specific Product Precautions

Be sure to read this before handling the products.

Refer to back page 50 for Safety Instructions and pages 3 to 12 for Actuator and Auto Switch Precautions.

Mounting

⚠ Caution

- Take care to avoid nicks or other damage on the outside surface of the cylinder tube.**
This can lead to a damage of the scraper and the wear ring, which in turn can cause malfunction.
- Use caution to the rotation of the external slider.**
Rotation should be controlled by connecting it to another shaft (linear guide, etc.).
- Do not operate with the magnetic coupling out of position.**
If the magnetic coupling is out of position, push the external slider by hand (or the piston slider with air pressure) back to the proper position at the stroke end.
- The cylinder is mounted with bolts through the mounting holes in the end covers. Be sure they are tightened securely.**
- Be sure that both end covers are secured to the mounting surface before operating the cylinder.**
Avoid operation with the external slider secured to the surface.
- Do not apply a lateral load to the external slider.**
When a load is mounted directly to the cylinder, variations in the alignment of each shaft center cannot be offset, which results in the generation of a lateral load that can cause malfunction. The cylinder should be operated using a connection method which allows for shaft alignment variations and deflection due to the cylinder's own mass. A drawing of a recommended mounting is shown in Fig. (2).

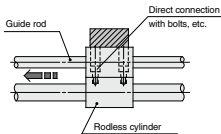

Variations in the load and cylinder shaft alignment cannot be offset and may result in a malfunction.

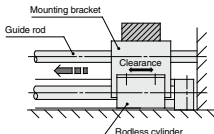

Shaft alignment variations are offset by providing clearance between the mounting bracket and cylinder. Moreover, the mounting bracket is extended above the cylinder shaft center, so that the cylinder is not subjected to moment.

Fig. (1) Incorrect mounting

Fig. (2) Recommended mounting

- Use caution regarding the allowable load mass when operating in a vertical direction.**

The allowable load mass when operating in a vertical direction (reference values on page 88) is determined by the model selection method. However, if a load greater than the allowable value is applied, the magnetic coupling may break and there is a possibility of dropping the load. When using this type of application, please contact SMC regarding the operating conditions (pressure, load, speed, stroke, frequency, etc.).

Disassembly and Maintenance

⚠ Caution

- Special tools are necessary for disassembly.

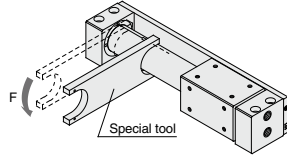

Special Tool Number

Part no.	Applicable bore size (mm)
CYRZ-V	15
CYRZ-W	25, 32

REA

REB

REC

Smooth

Low Speed

MQ

RHC

RZQ

D-□

-X□

Linear Guide Type Single Axis/Double Axes

REBH/REBHT Series

Single Axis: $\varnothing 15$, $\varnothing 25$

Double Axes: $\varnothing 25$, $\varnothing 32$



REA

REB

REC

Smooth

Low
Speed

MQ

RHC

RZQ

D-

-X

REBH Series Model Selection

P_v : Maximum operating pressure for vertical operation (MPa)

W_v : Allowable load mass for vertical operation (kg)

α : Load factor

$$\Sigma\alpha = \frac{\text{Load mass (W)}}{\text{Max. load mass (Wmax)}} + \frac{\text{Static moment (M)}}{\text{Allowable static moment (Mmax)}} + \frac{\text{Dynamic moment (Me)}}{\text{Allowable dynamic moment (Memax)}}$$

Operating Conditions

- W: Load mass (kg)
- U: Maximum speed (mm/s)
- P: Operating pressure (MPa)
- Stroke (mm)
- Position of workpiece center of gravity (m)
- Mode of operation (horizontal, inclined, vertical)

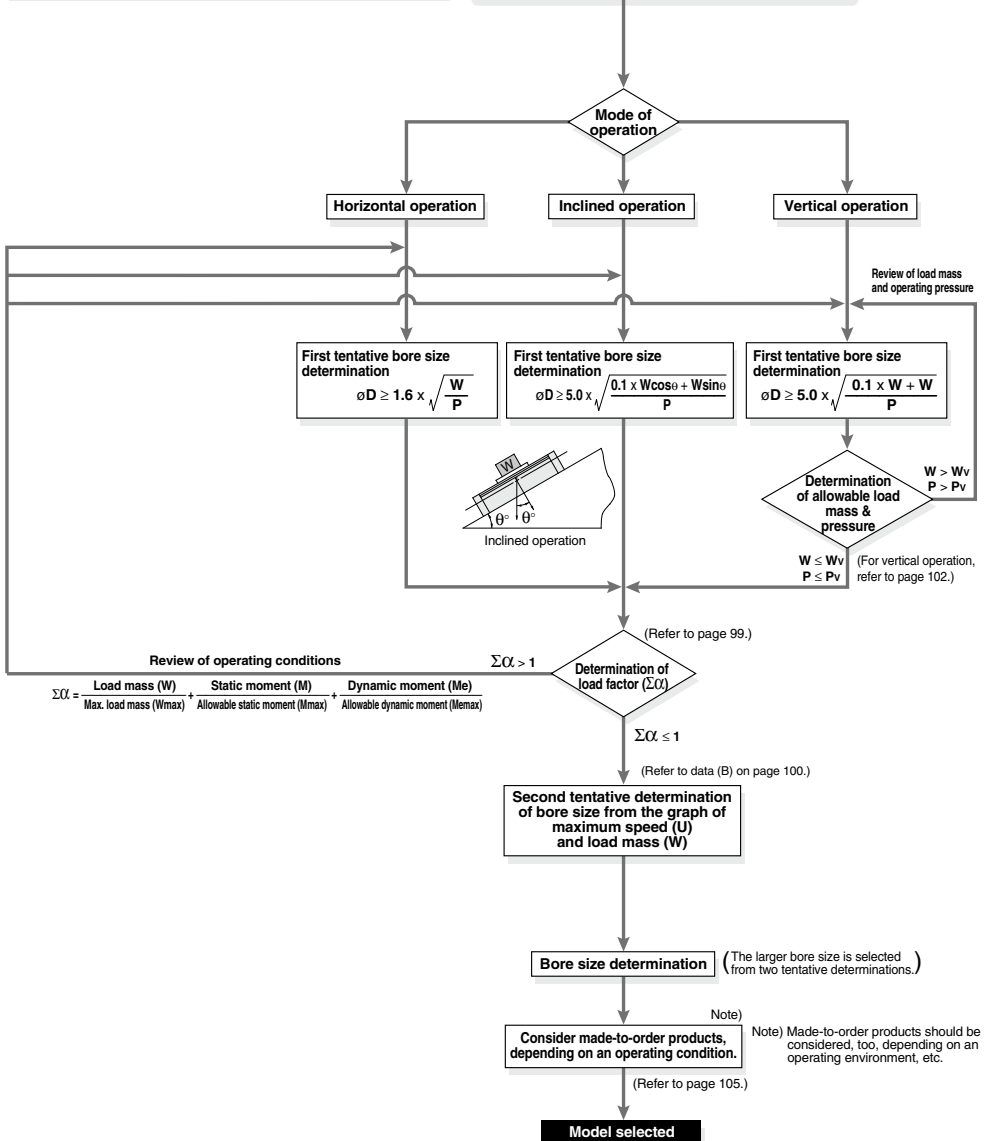

Caution on Design 1

The load mass allowable moment differs depending on the workpiece mounting method, cylinder mounting orientation and piston speed. In making a determination of usability, do not allow the sum ($\sum \alpha_n$) of the load factors (α_n) for each mass and moment to exceed "1".

$$\sum \alpha_n = \frac{\text{Load mass (W)}}{\text{Maximum load mass (Wmax)}} + \frac{\text{Static moment (M)}}{\text{Allowable static moment (Mmax)}} + \frac{\text{Dynamic moment (Me)}}{\text{Allowable dynamic moment (Memax)}} \leq 1$$

Caution on Design 2

Load Mass

Maximum Load Mass (kg)

Model	W _{max}
REBH15	9
REBH25	25
REBHT25	
REBHT32	40

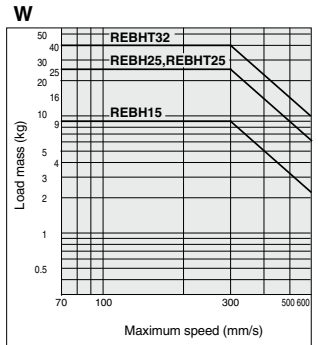
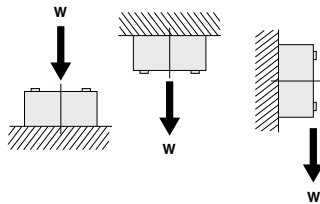

<Graph (1)>

Moment

Allowable Moment (Static moment/Dynamic moment) (N·m)

Model	M ₁	M ₂	M ₃
REBH15	10	16	10
REBH25	28	26	28
REBHT25	56	85	56
REBHT32	64	96	64

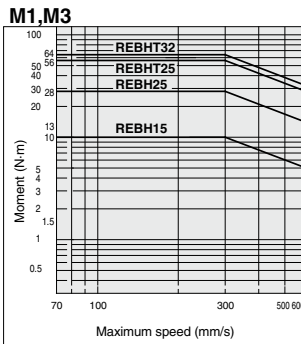
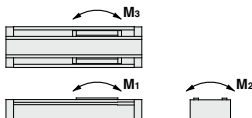

<Graph (2)>

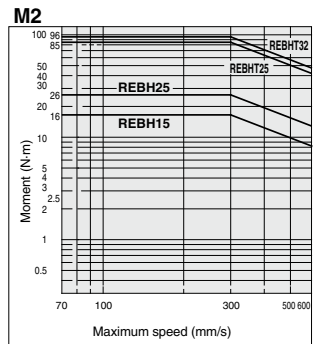

<Graph (3)>

REA

REB

REC

Smooth

Low

Speed

MQ

RHC

RZQ

D-□

-X□

REBH Series

Static Moment

Moment generated by the workpiece mass even when the cylinder is stopped

- Pitch moment
 $M_1 = W \cdot L$

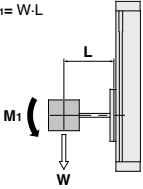

- Roll moment
 $M_2 = W \cdot L$

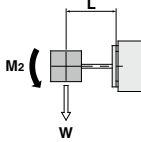

- Yaw moment
 $M_3 = W \cdot (L - A)$

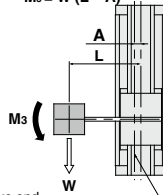

(mm)

Model	A
REBH15	17.5
REBH25	23.5
REBH25	0°
REBH32	0°

* Since there are 2 guides, the guides' central axis and the cylinder's central axis are the same.

Dynamic Moment

Moment generated by the load equivalent to impact at the stroke end

$$W_e = 5 \times 10^{-3} \cdot W \cdot g \cdot U$$

- W_e : Load equivalent to impact [N]
- W : Load mass [kg]
- U : Maximum speed [mm/s]
- g : Gravitational acceleration (9.8 m/s²)

- Pitch moment
 $Me_1 = 1/3 \cdot W_e \cdot L$

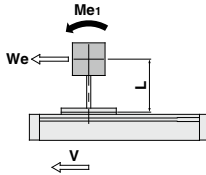

- Yaw moment
 $Me_3 = 1/3 \cdot W_e \cdot (L - A)$

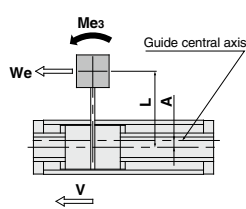

(mm)

Model	A
REBH15	17.5
REBH25	23.5
REBH25	0°
REBH32	0°

* Since there are 2 guides, the guides' central axis and the cylinder's central axis are the same.

<Data (B): Maximum speed—Load Mass Chart>

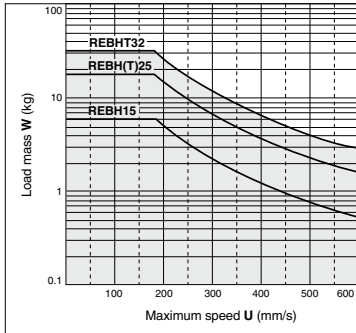

Selection Calculation

The selection calculation finds the load factors (α_n) of the items below, where the total ($\sum\alpha_n$) does not exceed 1.

$$\sum\alpha_n = \alpha_1 + \alpha_2 + \alpha_3 \leq 1$$

Item	Load factor α_n	Note
1. Max. load mass	$\alpha_1 = W/W_{max}$	Review W. W _{max} is the maximum load mass.
2. Static moment	$\alpha_2 = M/M_{max}$	Review M ₁ , M ₂ , M ₃ . M _{max} is the allowable moment.
3. Dynamic moment	$\alpha_3 = Me/M_{max}$	Review Me ₁ , Me ₃ . Me _{max} is the allowable moment.

U: Maximum speed

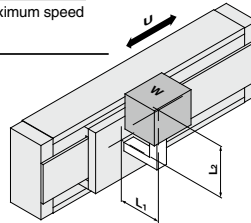

Calculation Example

Operating Conditions

Cylinder: REBH15
 Mounting: Horizontal wall mounting type
 Maximum speed: U = 500 [mm/s]
 Load mass: W = 1 [kg] (excluding mass of arm section)
 L₁ = 200 [mm]
 L₂ = 200 [mm]

Item	Load factor α_n	Note
1. Maximum load mass 	$\alpha_1 = W/W_{max}$ $= 1/3$ $= 0.111$ $= 0.333$	Examine W. (For W _{max} , find the value in <Graph (1)> when U = 500 mm/s.)
2. Static moment 	$M_2 = W \cdot L_1$ $= 10 \cdot 0.2$ $= 2 \text{ [N}\cdot\text{m]}$ $\alpha_2 = M_2/M_{2max}$ $= 2/16$ $= 0.125$	Examine M ₂ . Since M ₁ & M ₃ are not generated, investigation is unnecessary.
3. Dynamic moment 	$W_e = 5 \times 10^{-3} \cdot W \cdot g \cdot U$ $= 5 \times 10^{-3} \cdot 1 \cdot 9.8 \cdot 500$ $= 25 \text{ [N]}$ $M_{e3} = 1/3 \cdot W_e \cdot (L_2 - A)$ $= 1/3 \cdot 25 \cdot 0.182$ $= 1.52 \text{ [N}\cdot\text{m]}$ $\alpha_3 = M_{e3}/M_{e3max}$ $= 1.52/6$ $= 0.25$	Examine Me ₃ . (For Me _{max} , find the value in <Graph (2)> when U = 500 mm/s.)
	$M_{e1} = 1/3 \cdot W_e \cdot L_1$ $= 1/3 \cdot 25 \cdot 0.2$ $= 1.6 \text{ [N}\cdot\text{m]}$ $\alpha_4 = M_{e1}/M_{e1max}$ $= 1.6/6$ $= 0.27$	Examine Me ₁ . (For Me _{max} , find the value in <Graph (2)> when U = 500 mm/s.)

$$\begin{aligned} \sum\alpha_n &= \alpha_1 + \alpha_2 + \alpha_3 + \alpha_4 \\ &= 0.333 + 0.125 + 0.25 + 0.27 \\ &= 0.978 \leq 1 \end{aligned}$$

And it is possible to use.

REA

REB

REC

Smooth

Low Speed

MQ

RHC

RZQ

D-

-X

REBH Series

Caution on Design 2

Table Deflection Amount

Displacement of Table due to Pitch Moment Load

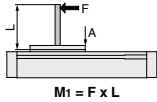

REBH15,25

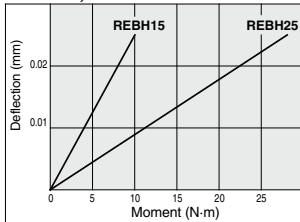

Displacement of Table due to Roll Moment Load

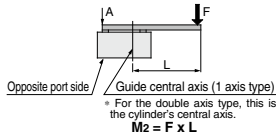

REBH15,25

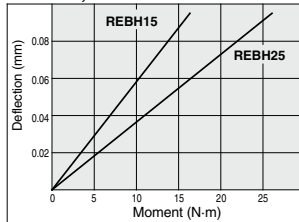

Displacement of Table due to Yaw Moment Load

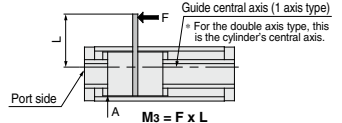

REBH15,25

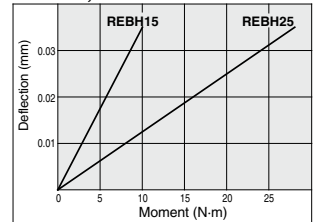

REBHT25,32

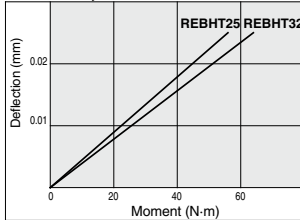

REBHT25,32

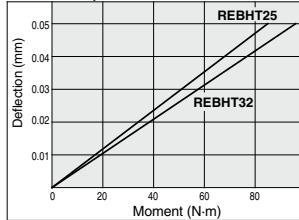

REBHT25,32

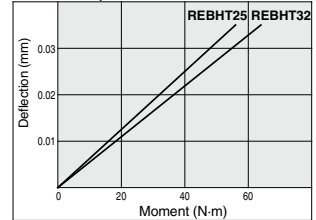

Note) Deflection when a moment other than the above is applied can be specified by extending the lines in the graphs above.

Vertical Operation

When using in vertical operation, prevention of workpiece dropping due to breaking of the magnetic coupling should be considered. The allowable load mass and maximum operating pressure should be as shown in the table below. When the cylinder is mounted vertically or sidelong, sliders may move downwards due to the self-weight or workpiece mass. If an accurate stopping position is required at the stroke end or the middle-stroke, use an external stopper to secure accurate positioning.

Model	Allowable load mass Wv (kg)	Maximum operating pressure Pv (MPa)
REBH15	7.0	0.65
REBH25	18.5	0.65
REBH25	18.5	0.65
REBHT32	30.0	0.65

Intermediate Stop

The cushion effect (smooth start-up, soft stop) exists only before the stroke end in the stroke ranges indicated in the table below. The cushion effect (smooth start-up, soft stop) cannot be obtained in an intermediate stop or a return from an intermediate stop using an external stopper, etc.

Cushion Stroke

Model	Stroke (mm)
REBH15	25
REBH25	30
REBHT25	30
REBHT32	30

Stroke Adjustment

The adjusting bolt is adjusted to the optimum position for smooth acceleration and deceleration at the time of shipment, and should be operated at the full stroke. When stroke adjustment is necessary, the maximum amount of adjustment on one side is 2 mm. (Do not adjust more than 2 mm, as it will not be possible to obtain smooth acceleration and deceleration.) Do not adjust based on the stopper's movement, as this can cause cylinder damage.

Stroke adjustment method

Loosen the round head Phillips screws, and remove the top covers and dust covers (4 pcs.). Then loosen the hexagon nut, and after performing the stroke adjustment from the plate side with a hexagon wrench, retighten and secure the hexagon nut.

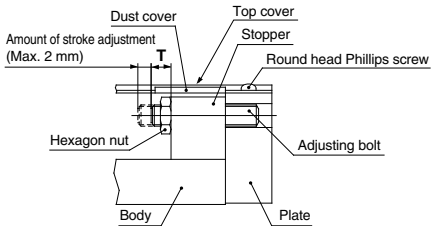

Adjusting Bolt Position (at the time of shipment), Hexagon Nut Tightening Torque

Model	T (mm)	Tightening torque (N·m)
REBH15	7	1.67
REBH25	9	3.14
REBHT25	9	
REBHT32	9	

After adjusting the stroke, replace the top covers and dust covers. Tighten the round head Phillips screws for securing the top covers with a torque of 0.58 N·m.

REA

REB

REC

Smooth

Low

Speed

MQ

RHC

RZQ

D-□

-X□

Sine Rodless Cylinder / Linear Guide Type

REBH Series

Single Axis: $\varnothing 15, \varnothing 25$ / Double Axes: $\varnothing 25, \varnothing 32$

How to Order

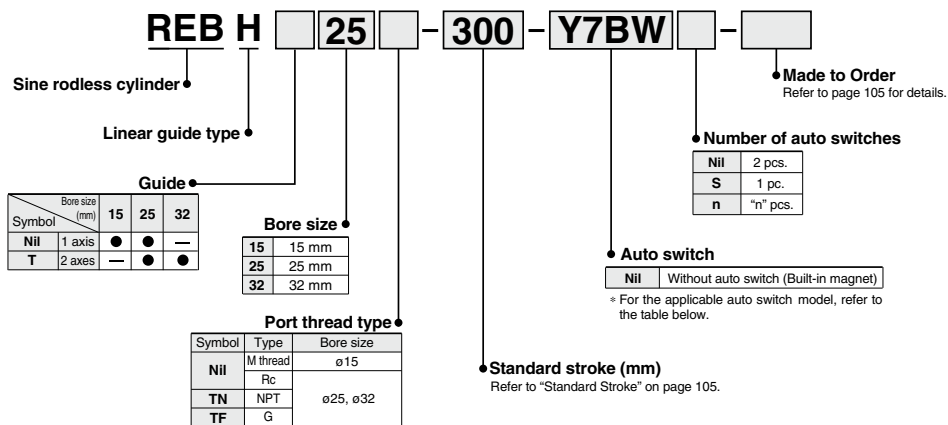

Applicable Auto Switches

Refer to pages 941 to 1067 for further information on auto switches.

Type	Special function	Electrical entry	Indicator light	Wiring (Output)	Load voltage		Auto switch model		Lead wire length (m)*			Pre-wired connector	Applicable load		
					DC	AC	Perpendicular	In-line	0.5 (Nil)	3 (L)	5 (Z)				
														Y69A	Y59A
Solid state auto switch	—	Grommet	Yes	3-wire (NPN)	5 V, 12 V	—	Y69A	Y59A	●	●	○	○	IC circuit	Relay, PLC	
				3-wire (PNP)			12 V	Y7PV	Y7P	●	●	○			○
	2-wire			24 V	Y69B		Y59B	●	●	○	○	—			
	3-wire (NPN)			5 V, 12 V	Y7NWV		Y7NW	●	●	○	○	IC circuit			
	3-wire (PNP)			12 V	Y7PWV		Y7PW	●	●	○	○	—			
Reed auto switch	Water resistant (2-color indicator)	Grommet	Yes	3-wire (NPN equivalent)	5 V	—	—	Z76	●	●	—	—	IC circuit	—	
				2-wire	24 V	12 V	100 V	—	Z73	●	●	●	—	—	Relay, PLC
					5 V, 12 V	100 V or less	—	Z80	●	●	—	—	IC circuit		
				—	—	—	—	—	—	—	—	—	—	—	—

** Water resistant type auto switches can be mounted on the above models, but in such case SMC cannot guarantee water resistance. Consult with SMC regarding water resistant types with the above model numbers.

* Lead wire length symbols: 0.5 m Nil (Example) Y59A
 3 m L (Example) Y59AL
 5 m Z (Example) Y59AZ

* Solid state auto switches marked with "○" are produced upon receipt of order.

• Since there are other applicable auto switches than listed, refer to page 110 for details.
 • For details about auto switches with pre-wired connector, refer to pages 1014 and 1015.
 * Auto switches are shipped together (not assembled).

Specifications



Symbol

Air cushion
(Magnet type)



Made to Order: Individual Specifications
(For details, refer to page 112.)

Symbol	Specifications
-X168	Helical insert thread specifications

Made to Order Specifications

[Click here for details](#)

Symbol	Specifications
-XB10	Intermediate stroke (Using exclusive body)

Bore size (mm)	15	25	32
Fluid	Air		
Maximum operating pressure	0.7 MPa		
Minimum operating pressure	0.2 MPa		
Proof pressure	1.05 MPa		
Ambient and fluid temperature	-10 to 60°C (No freezing)		
Piston speed (Max.) ^{Note)}	70 to 600 mm/s		
Lubrication	Not required (Non-lube)		
Stroke length tolerance	0 to 1.8 mm		
Piping	Centralized piping type		
Piping port size	M5 x 0.8	Rc 1/8	
Holding force (N)	137	363	588

Note) Piston speed above indicates the maximum speed. It takes approximately 0.5 seconds (for one side) after the slide table moves from the stroke end until it goes through the cushion stroke, while it takes approximately 1 second for both sides.

Standard Stroke

Bore size (mm)	Number of axes	Standard stroke (mm)	Maximum manufacturable stroke (mm)
15	1 axis	150, 200, 300, 400, 500	750
25		200, 300, 400, 500, 600, 800	
25	2 axes	200, 300, 400, 500, 600, 800, 1000	1200
32			1500

Note 1) Stroke exceeding the standard stroke will be available upon request for special.

Note 2) Intermediate strokes other than made-to-order (refer to -XB10) are available as special.

Weight

Model	Standard stroke (mm)							
	150	200	300	400	500	600	800	1000
REBH15	2.5	2.7	3.2	3.6	4.1	—	—	—
REBH25	—	5.3	6.0	6.6	7.3	8.0	9.4	—
REBHT25	—	6.2	7.3	8.3	9.4	10.4	12.5	14.6
REBHT32	—	9.6	10.7	11.9	13.0	14.2	16.5	18.8

Theoretical Output

Bore size (mm)	Piston area (mm ²)	Operating pressure (MPa)					
		0.2	0.3	0.4	0.5	0.6	0.7
15	176	35	52	70	88	105	123
25	490	98	147	196	245	294	343
32	804	161	241	322	402	483	563

Note) Theoretical output (N) = Pressure (MPa) x Piston area (mm²)

REA

REB

REC

Smooth

Low Speed

MQ

RHC

RZQ

D-□

-X□

REBH Series

Construction: $\varnothing 15, \varnothing 25$

Single axis type: REBH

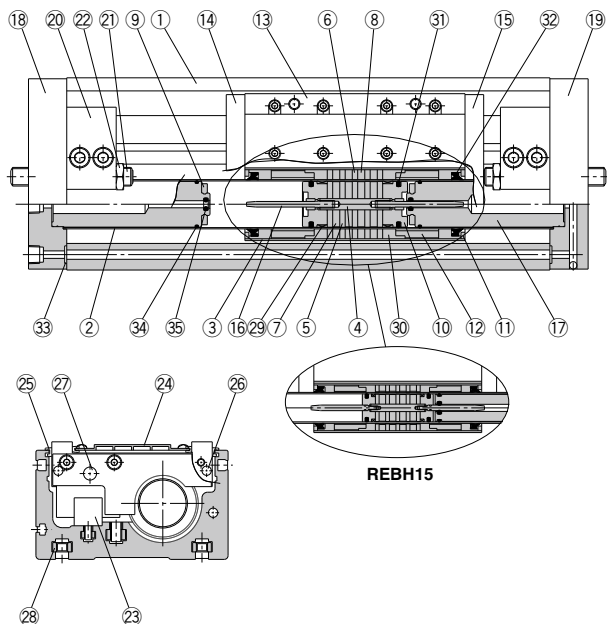

Component Parts

No.	Description	Material	Note
1	Body	Aluminum alloy	Hard anodized
2	Cylinder tube	Stainless steel	
3	External slider tube	Aluminum alloy	
4	Shaft	Stainless steel	
5	Piston side yoke	Rolled steel plate	Zinc chromated
6	External slider side yoke	Rolled steel plate	Zinc chromated
7	Magnet A	—	
8	Magnet B	—	
9	Bumper	Urethane rubber	Except REBH15
10	Piston	Aluminum alloy	Chromated
11	Spacer	Rolled steel plate	Nickel plated
12	Space ring	Aluminum alloy	Chromated
13	Slide table	Aluminum alloy	Hard anodized
14	Side plate A	Aluminum alloy	Hard anodized
15	Side plate B	Aluminum alloy	Hard anodized
16	Cushion ring	Stainless steel	Compound electroless nickel plated
17	Internal stopper	Aluminum alloy	Anodized
18	Plate A	Aluminum alloy	Hard anodized

Component Parts

No.	Description	Material	Note
19	Plate B	Aluminum alloy	Hard anodized
20	Stopper	Aluminum alloy	Anodized
21	Adjusting bolt	Chromium molybdenum steel	Nickel plated
22	Hexagon nut	Carbon steel	Nickel plated
23	Linear guide		
24	Top cover	Aluminum alloy	Hard anodized
25	Dust cover	Special resin	
26	Magnet (for auto switch)	—	
27	Parallel pin	Carbon steel	Nickel plated
28	Square nut for body mounting	Carbon steel	Nickel plated (Accessory)
29	Wear ring A	Special resin	
30	Wear ring B	Special resin	
31	Piston seal	NBR	
32	Scraper	NBR	
33	O-ring	NBR	
34	O-ring	NBR	
35	Cushion seal	NBR	

Note) Square nut for body mounting ⑳: 4 pieces

Replacement Parts/Seal Kit

Bore size (mm)	Kit no.	Contents
15	REBH15-PS	Set of nos. above ㉑, ㉒, ㉓, ㉔, ㉕, ㉖, ㉗, ㉘, ㉙, ㉚, ㉛, ㉜, ㉝, ㉞, ㉟, ㊱, ㊲, ㊳, ㊴, ㊵, ㊶, ㊷, ㊸, ㊹, ㊺, ㊻, ㊼, ㊽, ㊾, ㊿
25	REBH25-PS	㉑, ㉒, ㉓, ㉔, ㉕, ㉖, ㉗, ㉘, ㉙, ㉚, ㉛, ㉜, ㉝, ㉞, ㉟, ㊱, ㊲, ㊳, ㊴, ㊵, ㊶, ㊷, ㊸, ㊹, ㊺, ㊻, ㊼, ㊽, ㊾, ㊿

Note) Cushion seal ㉞ may be difficult to be replaced.

* Seal kit includes a grease pack (10 g).

Order with the following part number when only the grease pack is needed.

Grease pack part no.: GR-S-010 (10 g)

Construction: $\varnothing 25, \varnothing 32$

Double axis type: REBHT

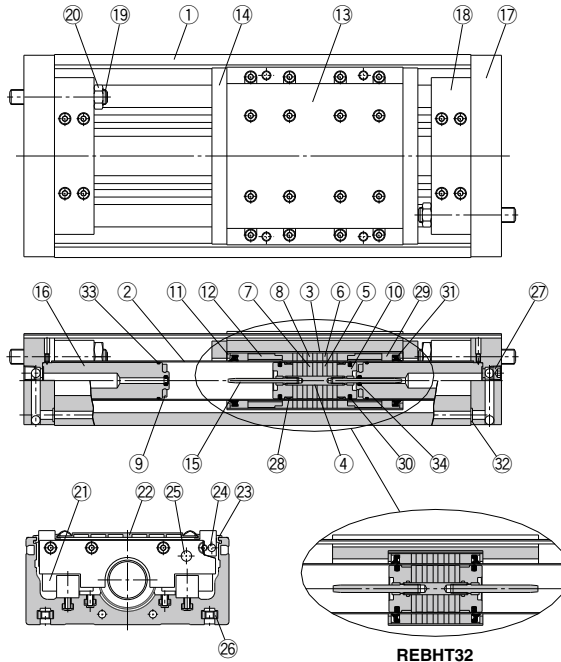

REBHT32

Component Parts

No.	Description	Material	Note
1	Body	Aluminum alloy	Hard anodized
2	Cylinder tube	Stainless steel	
3	External slider tube	Aluminum alloy	
4	Shaft	Stainless steel	
5	Piston side yoke	Rolled steel plate	Zinc chromated
6	External slider side yoke	Rolled steel plate	Zinc chromated
7	Magnet A	—	
8	Magnet B	—	
9	Bumper	Urethane rubber	
10	Piston	Aluminum alloy	Chromated
11	Spacer	Rolled steel plate	Nickel plated
12	Space ring	Aluminum alloy	Chromated (Except REBHT32)
13	Slide table	Aluminum alloy	Hard anodized
14	Side plate	Aluminum alloy	Hard anodized (Except REBHT32)
15	Cushion ring	Stainless steel	REBHT25 Compound electroless nickel plated
		Brass	REBHT32
16	Internal stopper	Aluminum alloy	Anodized
17	Plate	Aluminum alloy	Hard anodized

Component Parts

No.	Description	Material	Note
18	Stopper	Aluminum alloy	Anodized
19	Adjusting bolt	Chromium molybdenum steel	Nickel plated
20	Hexagon nut	Carbon steel	Nickel plated
21	Linear guide		
22	Top cover	Aluminum alloy	Hard anodized
23	Dust cover	Special resin	
24	Magnet (for auto switch)	—	
25	Parallel pin	Carbon steel	Nickel plated
26	Square nut for body mounting	Carbon steel	Nickel plated (Accessory)
27	Hexagon socket head taper plug	Carbon steel	Nickel plated
28	Wear ring A	Special resin	
29	Wear ring B	Special resin	
30	Piston seal	NBR	
31	Scraper	NBR	
32	O-ring	NBR	
33	O-ring	NBR	
34	Cushion seal	NBR	

Note) Square nut for body mounting 26: 4 pieces

Replacement Parts/Seal Kit

Bore size (mm)	Kit no.	Contents
25	REBHT25-PS	Set of nos. above 28, 29, 30, 31, 32, 33, 34
32	REBHT32-PS	

Note) Cushion seal 34 may be difficult to be replaced.

* Seal kit includes a grease pack (10 g).

Order with the following part number when only the grease pack is needed.

Grease pack part no.: GR-S-010 (10 g)

- REA
- REB**
- REC
- Smooth
- Low Speed
- MQ
- RHC
- RZQ

- D-□
- X□

REBH Series

Dimensions: $\varnothing 15, \varnothing 25$

Single axis type: REBH

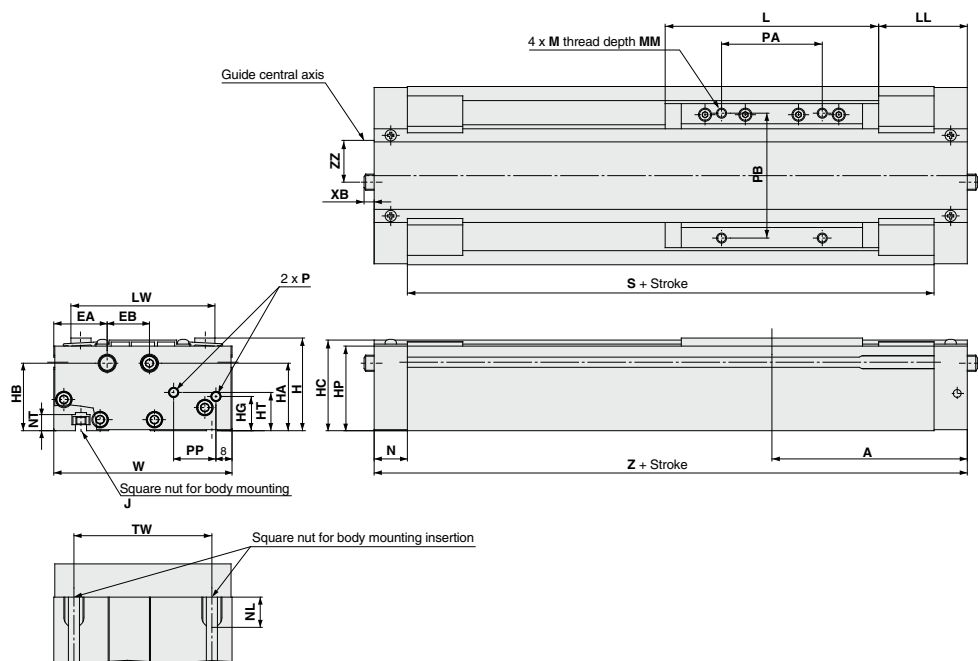

Model	A	EA	EB	H	HA	HB	HC	HG	HP	HT	J	L	LL	LW	M	MM
REBH15	97	26.5	21	46	33.5	33.5	45	17	42	19	M5 x 0.8	106	44	71.5	M5 x 0.8	8
REBH25	125	29	24	63	46	46	61.5	25	58.5	28	M6 x 1.0	138	56	86	M6 x 1.0	10

Model	N	NL	NT	P	PA	PB	PP	S	TW	W	XB	Z	ZZ
REBH15	16.5	15	8	M5 x 0.8	50	62	21	161	65	88.5	—	194	17.5
REBH25	20.5	18	9	1/8	65	75	27	209	75	103	9.5	250	23.5

Dimensions: $\varnothing 25$, $\varnothing 32$

Double axis type: REBHT

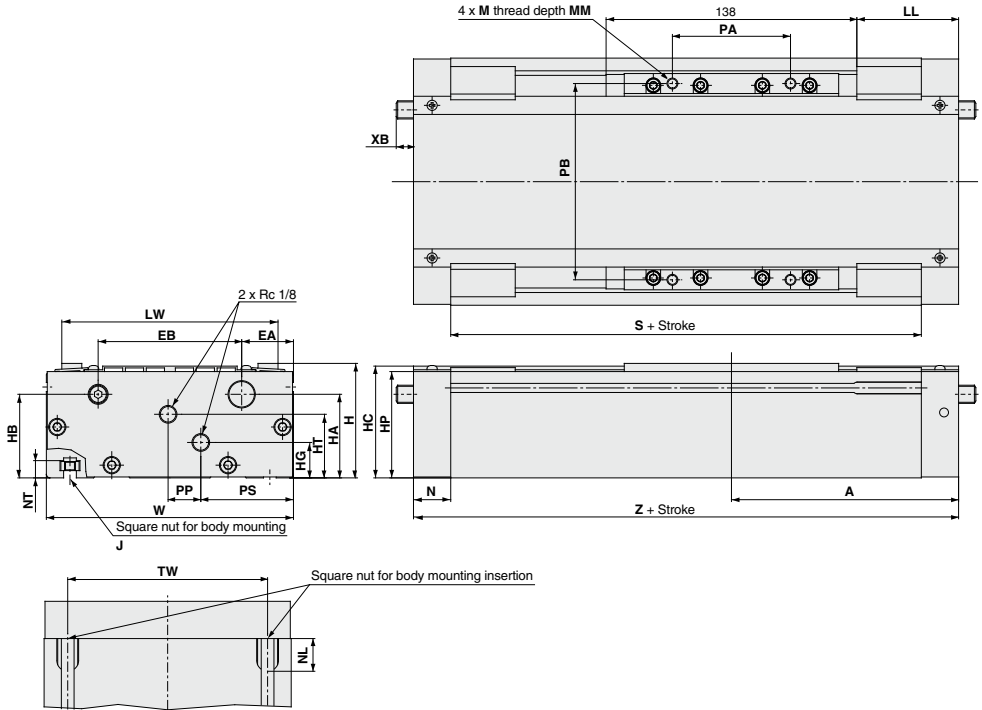

- REA
- REB**
- REC
- Smooth
- Low Speed
- MQ
- RHC
- RZQ

Model	A	EA	EB	H	HA	HB	HC	HG	HP	HT	J	LL	LW	M	MM	N
REBHT25	125	28.5	79	63	46	46	61.5	19.5	58.5	35	M6 x 1.0	56	119	M6 x 1.0	10	20.5
REBHT32	132.5	30	90	75	52.5	57.5	72.5	25	69.5	43	M8 x 1.25	63.5	130	M8 x 1.25	12	23

Model	NL	NT	PA	PB	PP	PS	S	TW	W	XB	Z
REBHT25	18	9	65	108	18	51	209	110	136	9.5	250
REBHT32	22.5	12	66	115	14	61	219	124	150	2	265

- D-
- X

REBH Series Auto Switch Mounting

Proper Auto Switch Mounting Position (Detection at stroke end)

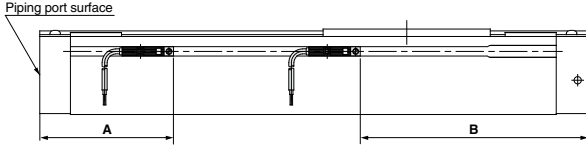

Proper Auto Switch Mounting Position

Auto switch model Cylinder model	A dimension			B dimension		
	D-Z7□ D-Z80	D-Y7□W D-Y7□WV	D-V5□ D-V6□ D-Y7P D-Y7PV	D-Z7□ D-Z80	D-Y7□W D-Y7□WV	D-V5□ D-V6□ D-Y7P D-Y7PV
REBH15		72			122	
REBH25		86			164	
REBHT25		86			164	
REBHT32		82			183	

Note) Adjust the auto switch after confirming the operating conditions in the actual setting.

Operating Range

Auto switch model	Bore size (mm)			
	REBH		REBHT	
	15	25	25	32
D-Z7□/Z8□	6	6	6	9
D-V5□/V6□/Y7□	5	5	5	6

* Since this is a guideline including hysteresis, not meant to be guaranteed. (assuming approximately ±30% dispersion)

There may be the case it will vary substantially depending on an ambient environment.

Auto Switch Lead Wire Containment Groove

On model REBH25 a groove is provided on the side of the body (one side only) to contain auto switch lead wires. This should be used for placement of wiring.

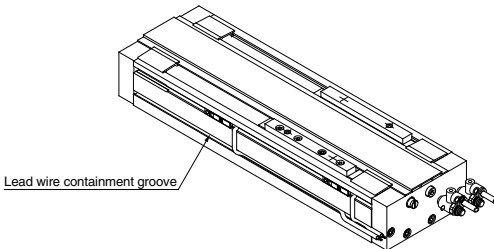

Other than the models listed in "How to Order", the following auto switches are applicable.

For detailed specifications, refer to pages 941 to 1067.

* Normally closed (NC = b contact) solid state auto switches (D-Y7G/Y7H types) are also available. Refer to page 961 for details.



REBH Series

Specific Product Precautions

Be sure to read this before handling the products.

Refer to back page 50 for Safety Instructions and pages 3 to 12 for Actuator and Auto Switch Precautions.

Mounting

⚠ Caution

1. The interior is protected to a certain extent by the top cover, however, when performing maintenance, etc., take care not to cause scratches or other damage to the cylinder tube, slide table or linear guide by striking them or placing objects on them.
Cylinder bores are manufactured to precise tolerances, so that even a slight deformation may cause faulty operation.
2. Because the slider is supported by precision bearings, take care not to apply strong impacts or excessive moments to the table when loading a workpiece.
3. Mounting of the cylinder body.
The body is mounted using the square nuts, which are included, in the two T-slots on the bottom of the body. Refer to the table below for mounting bolt dimensions and tightening torque.

Model		REBH15	REBH25	REBH25	REBHT32
Bolt dimensions	Thread size	M5 x 0.8	M6 x 1.0		M8 x 1.25
	Dimension t	L-8	L-9		L-12
Tightening torque	N·m	2.65	4.4		13.2

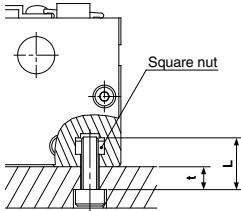

Operation

⚠ Caution

1. The unit can be used with a direct load within the allowable range, but when connecting to a load which has an external guide mechanism, careful alignment is necessary.
Since variation of the shaft center increases as the stroke becomes longer, a connection method should be devised which allows for this displacement.
2. Since the guide is adjusted at the time of shipment, unintentional movement of the adjustment setting should be avoided.
3. Please contact SMC before operating in an environment where there will be contact with cutting chips, dust (paper debris, lint, etc.) or cutting oil (gas oil, water, warm water, etc.).
4. Do not operate with the magnetic coupling out of position.

In case the magnetic coupling is out of position, push the external slider back into the correct position by hand at the end of the stroke (or correct the piston slider with air pressure).

REA

REB

REC

Smooth

Low Speed

MQ

RHC

RZQ

D-□

-X□

REA/REB Series

Made to Order: Individual Specifications 1

Please contact SMC for detailed dimensions, specifications and lead times.



1 Helical Insert Thread Specifications Symbol **-X168**

REA
REAS
REAL **Bore size** - **Stroke** - **X168**
REAH
REBH Helical insert thread specifications

The standard mounting threads have been changed to helical insert specifications.

Specifications

Applicable series	REA/REAS/REAL/REAH/REBH
Bore size	REA: ø25 to ø63 REAS/REAL: ø20 to ø40 REAH: ø20 to ø32 REBH: ø25, ø32

The mounting thread positions and size are the same as standard.

2 Additional Moving Element Mounting Taps Symbol **-X206**

REA **Bore size** - **Stroke** - **X206**

Additional moving element mounting taps

Mounting taps have been added on the surface opposite the standard positions.

Specifications

Applicable series	REA
Bore size	ø25 to ø63

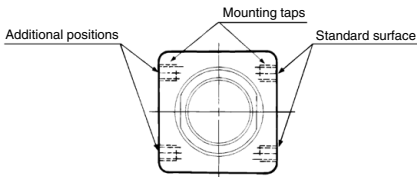

*Dimensions are the same as the standard product.

3 Non-lubricated Exterior Specifications Symbol **-X210**

REA
REAS **Bore size** - **Stroke** - **X210**

Non-lubricated exterior specifications

Suitable for environments where oil is not tolerated. A scraper is not installed. A separate version -X324 (with a felt dust seal) is available in cases in which dust, etc. is dispersed throughout the environment.

Specifications

Applicable series	REA/REAS	
Bore size	REA	ø25 to ø63
	REAS	ø10 to ø40

Construction

REA (Basic type)

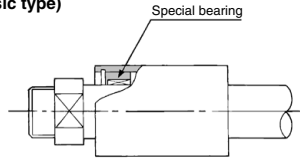

REAS (Slider type)

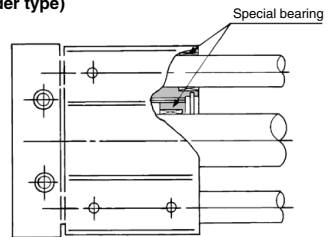

REA/REB Series

Made to Order: Individual Specifications 2

Please contact SMC for detailed dimensions, specifications and lead times.



4 Non-lubricated Exterior Specifications with Dust Seal **-X324**

REA **Bore size** - **Stroke** - **X324**
 REAS

Non-lubricated exterior specifications with dust seal

Non-lubricated exterior type with a felt dust seal on the cylinder body.

Specifications

Applicable series		REA/REAS
Bore size	REA	ø25 to ø63
	REAS	ø10 to ø40

Construction

REA (Basic type)

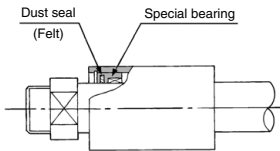

REAS (Slider type)

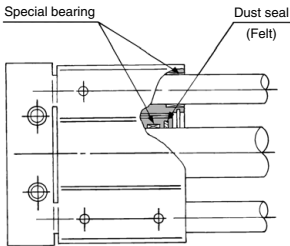

5 Auto Switch Rails on Both Side Faces (With 2 pcs.) **-X431**

REAS **Bore size** - **Stroke** - **X431**

Auto switch rails on both side faces (With 2 pcs.)

This auto switch is effective in the case of short strokes.

Specifications

Applicable series	REAS
Bore size	ø10 to ø40

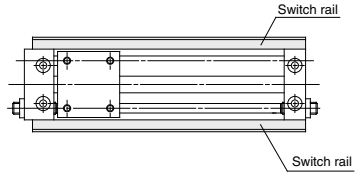

REA

REB

REC

Smooth

Low Speed

MQ

RHC

RZQ

D-□

-X□