

Low Friction Cylinders

MQ Series

Metal Seal Type

RoHS



Compact Low Friction Cylinder MQQ Series

P.322

Series	Bore size (mm)	Operating pressure range (MPa)	Actuation speed (mm/s)
MQQT Standard type	10	0.005 to 0.5	0.3 to 300
	16		
	20		
MQQL Lateral load resisting type (Built-in ball bushing)	25	0.005 to 0.7	0.5 to 500
	30		
	40		



Lateral Load Resisting Low Friction Cylinder MQM Series

P.331

Series	Bore size (mm)	Operating pressure range (MPa)	Actuation speed (mm/s)
MQML Standard type	6 (Standard only)	$\phi 6$: 0.02 to 0.7 $\phi 10$ to $\phi 25$: 0.005 to 0.7	0.5 to 1000
	10		
	16		
MQML □ □ H High speed/frequency	20	0.01 to 0.7	5 to 3000
	25		



Low Friction Cylinder (Single Acting) MQP Series

P.342

Series	Bore size (mm)	Operating pressure range (MPa)	Thrust control standard (N)
MQP	$\phi 4$	0.001 to 0.7 (Except for moving parts mass)	0.01 to 8
	$\phi 6$		0.03 to 19
	$\phi 10$		0.08 to 50
	$\phi 16$		0.20 to 140
	$\phi 20$		0.30 to 200

REA

REB

REC

Smooth

Low Speed

MQ

RHC

RZQ

D-□

-X□

Low pressure actuation

Minimal sliding resistance allows low pressure actuation at 0.005 MPa.
* Contact SMC regarding vacuum applications.

Low Friction Cylinders

MQQ Series

MQM Series

Metal seal structure with low sliding speed and an output control, which

Long service life

Long service life of 10,000 km or 100 million full cycles.

Low and uniform speed actuation

Smooth, uniform speed actuation ranges as low as 0.3 mm/s.

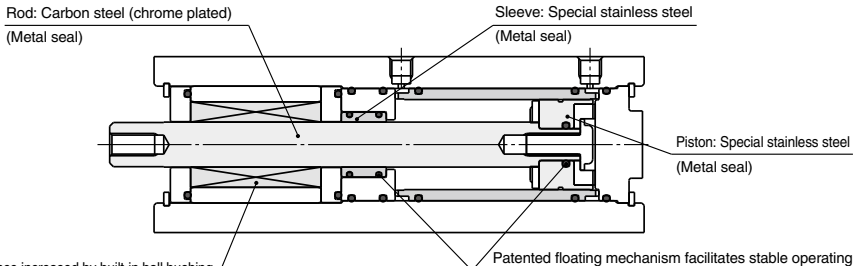

Lateral load resistance increased by built-in ball bushing
* MQQT type made of fluororesin.

Patented floating mechanism facilitates stable operating resistance without galling due to shaft slippage.

Low friction

Low sliding resistance and high stability allow force control as low as 0.05 N. (Based on cylinder Piston area x Pressure accuracy)
No increased sliding resistance after not operating for a long period of time.

Lateral load resistance

Lateral load resistance is increased by built-in ball bushing. (MQQL/MQML)

Series Variation

MQQ Series

Compact low friction cylinders designed for low pressure, low speed, uniform speed or low friction applications



Series	Bore size (mm)	Stroke (mm)								Operating pressure range (MPa)	Actuation speed (mm/s)
		10	20	30	40	50	60	75	100		
MQQT Standard type	10	●	●	●	●	●	●	●	●	0.005 to 0.5	0.3 to 300
	16	●	●	●	●	●	●	●	●		
	20	●	●	●	●	●	●	●	●		
MQQL Lateral load resisting type (Built-in ball bushing)	25	●	●	●	●	●	●	●	●	0.005 to 0.7	0.5 to 500
	30	●	●	●	●	●	●	●	●		
	40	●	●	●	●	●	●	●	●		

MQM Series

Lateral load resisting low friction cylinders for low pressure, low speed, uniform speed, low friction high pressure, high speed and high speed response (high frequency) actuation



Series	Bore size (mm)	Stroke (mm)					Operating pressure range (MPa)	Actuation speed (mm/s)
		15	30	45	60	75		
MQML Standard type	6 (standard only)	●	●	●	●	●	ø6: 0.02 to 0.7 ø10 to ø25: 0.005 to 0.7	0.5 to 1000
	10	●	●	●	●	●		
	16	●	●	●	●	●		
MQML□□H High speed/frequency	20	●	●	●	●	●	0.01 to 0.7	5 to 3000
	25	●	●	●	●	●		

(Metal Seal Type)

/ $\varnothing 10, \varnothing 16, \varnothing 20, \varnothing 25, \varnothing 30, \varnothing 40$

/ $\varnothing 6, \varnothing 10, \varnothing 16, \varnothing 20, \varnothing 25$

resistance enables to cover the range of a driving were not available with the general cylinder.

High speed, High frequency actuation

H type achieves speeds up to 3,000 mm/s (without fixed orifice), and continuous actuation up to 50 cycles per second. (MQML□□H)

*Refer to page 341 for kinetic energy.

Application Examples

For pressure controlling with fine pressure variations

Applicable models: MQQT/MQML

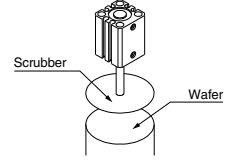

Polishing wafers

REA

REB

REC

Smooth

Low Speed

MQ

RHC

RZQ

For cutting glasses and lenses, requiring constant force

Applicable models: MQQL/MQML

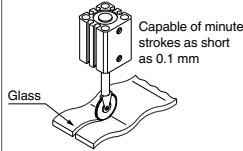

Cutting wavy surfaces

Tension controlling responding to very low pressure and minute pressure variations

Applicable models: MQQL/MQML

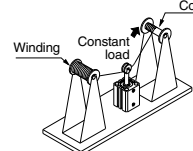

Coil winding

For transferring precision components, etc., that require low or uniform speed actuation

Applicable models: MQQT/MQML

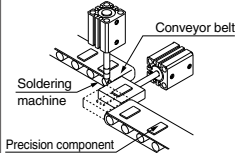

Transferring precision components

For eliminating non-conforming articles requiring high speed actuation

Applicable models: MQML/MQML□□H

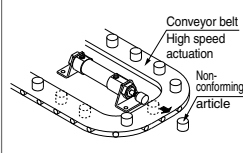

Eliminating non-conforming articles

For punching operations requiring high frequency actuation

Applicable models: MQML/MQML□□H

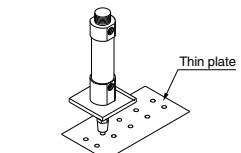

Punching

Recommended Circuit Examples

Example 1) Uniform & low speed actuation (no control of cylinder output)

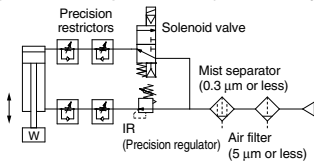

* When using a solenoid valve, use a metal seal type (VQ, VQZ, SQ series, etc.).

Example 3) High speed & high frequency actuation

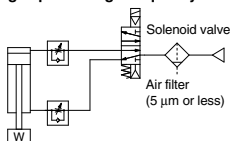

* When using a solenoid valve, use a metal seal type (VQ, VQZ, SQ series, etc.).

Example 2) Low speed with output control

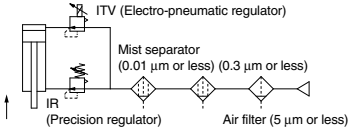

* When performing control of cylinder output, do not create a restriction circuit using a speed controller, etc. Pressure inside the cylinder will drop and control will become impossible. Always control actuation by means of pressure control. Besides, when using as pressing force or tension control (actuated by external force), air contained inside cylinder is discharged from a relief port on the regulator. When the pressure inside a cylinder is increased by displacement (stroke) or driving speed, etc., install an air tank.

Applications based on low friction specification

- 1) Operating resistance will vary with an offset load. Be sure to properly align the rod axis with the load and direction of movement when connecting. When an offset load is expected, provide a suitable mechanism such as a floating joint.
- 2) Use clean air (atmospheric pressure dew point temperature -10°C or less). Using the AM series mist separator (nominal filtration rating of 0.3 μm or less), or the AM + AMD series (nominal filtration rating of 0.01 μm or less) is recommended.

D-□

-X□

Low Friction Cylinder MQP Series



Fully covers a pressure force

No lurching

Even extremely small degree lurching such as 0.01 mm does not occur. A special air supply, such as for static bearings, is not required.

No piston

Sliding resistance is drastically decreased because the piston and the rod share the same shaft.

Special single acting/Piston retraction by external force

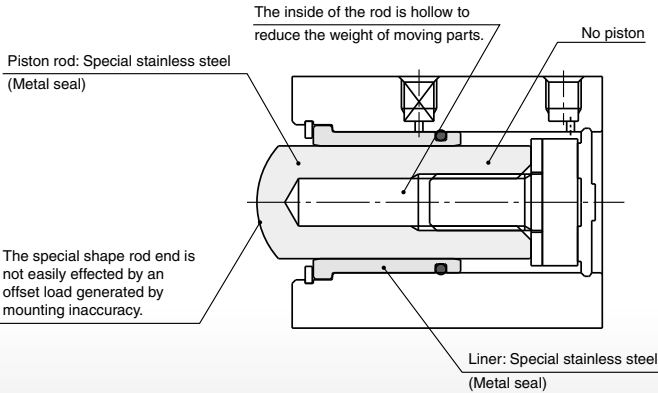
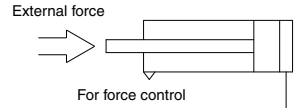

Reduced thrust dispersion

Dispersion of piston diameter: 3 μm or less
Readjusting thrust is not necessary when the cylinder is replaced.
Dispersion of thrust does not occur even more than one cylinder is connected to the same circuit, either. (Depends on the operation environment.)

Low friction and soft-touching

Possible to control the output in increments of 0.01 N. (Depends on the piston area of a cylinder x pressure accuracy)
In addition, sliding resistance does not change after periods of non-operation.

High-precision linear control

Delicate and precise linear movement control is possible.

MQP Series

Low friction cylinder suitable for low friction, force control.

Bore size [mm] (Pressure receiving diameter)	Stroke [mm]	Operating pressure range [MPa]	Mass of moving parts [g]	Thrust control standard [N]
$\phi 4$	10	0.001 to 0.7 (Excluding the mass of moving parts)	4	0.01 to 8
$\phi 6$			8	0.03 to 19
$\phi 10$			24	0.08 to 50
$\phi 16$			62	0.20 to 140
$\phi 20$			103	0.30 to 200

(Metal Seal Type/Single Acting)

/ø4, ø6, ø10, ø16, ø20

control range of 0.01 N to 200 N

Application Examples: For force control responding to a slight pressure fluctuation

Application examples for a single acting model

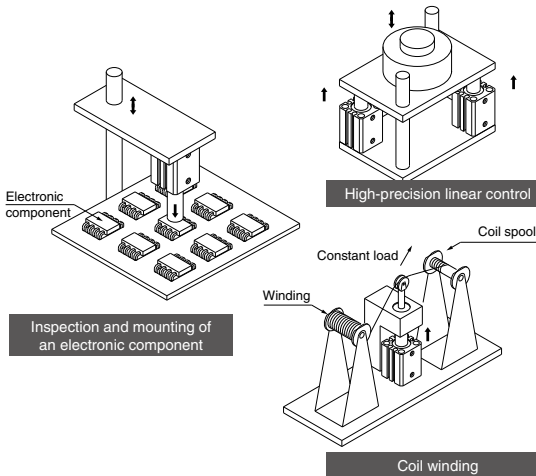

Application example for a double acting model

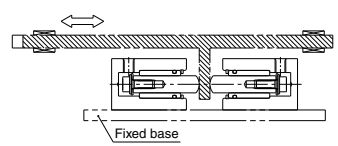

Using two MQP cylinders can improve the thrusting accuracy of an MQQ and/or MQM double acting metal cylinder. Additionally, equal strength of both extension and retracting thrust can be obtained.

Recommended Circuit Examples

Example 1) Normal operation

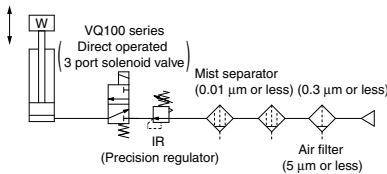

- 1) When using a solenoid valve, SMC recommends you use the VQ100 series in which the lubricant in the main valve will not flow out.
- 2) Do not use a speed controller in the circuit. If it is used, accurate thrust control may not be possible because the internal pressure of a cylinder will drop. Be sure to employ pressure control for control operations.

Example 2) Soft-touch operation

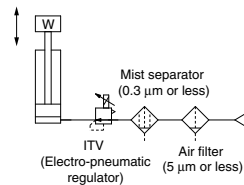

Made to Order

- Vacuum retraction cylinder
- Single acting, spring return type (Built-in springs)
- Tubing with a maximum of ø40 (I.D.) is available.

REA

REB

REC

Smooth

Low Speed

MQ

RHC

RZQ

Metal Seal

Compact Low Friction Cylinder

MQQ Series

ø10, ø16, ø20, ø25, ø30, ø40



How to Order

MQQ **T** **B** **10** **-** **10** **D**

Compact low friction specification

Type

T	Standard type
L	Lateral load resisting type (Built-in ball bushing)

Mounting

B	Through hole & Double end tapped (Standard)
L	Foot type
F	Rod side flange type
G	Head side flange type
D (Note)	Double clevis type

Note) Available with the MQQL□ only.
* Mounting brackets are included when shipped, but unassembled.

Bore size

10	10 mm
16	16 mm
20	20 mm
25	25 mm
30	30 mm
40	40 mm

Body option

Nil	Standard (Rod end female thread)
M (Note)	Rod end male thread

Note) A rod end thread adapter is attached.
* A rod end thread adapter is shipped being assembled.

Action

D	Double acting
---	---------------

Cylinder stroke

Bore size (mm)	Standard stroke (mm)
10	10, 20, 30, 40
16	10, 20, 30, 40, 50, 60
20	10, 20, 30, 40, 50, 60
25	10, 20, 30, 40, 50, 75, 100
30	10, 20, 30, 40, 50, 75, 100
40	10, 20, 30, 40, 50, 75, 100

* Strokes are available in 1 mm increments by installing a spacer in standard stroke cylinders.
Example: MQQTB10-15D
(5 mm width spacer is installed in MQQTB10-20D to adjust the stroke.)

Port thread type

Nil	M thread	ø10 to ø20
	Rc	
TN	NPT	ø25 to ø40
TF	G	

* The MQQ series is not auto switch capable.

Mounting Bracket Part No.

Bore size (mm)	Foot (Note 1)	Flange	Double clevis	Rod end thread adapter (with nut)
10	CQS-L016	CQS-F016	CQS-D016	MQ10-M
16	CQS-L020	CQS-F020	CQS-D020	MQ16-M
20	CQS-L025	CQS-F025	CQS-D025	MQ20-M
25	MQ-L032	MQ-F032	MQ-D032	MQ25-M
30	MQ-L040	MQ-F040	MQ-D040	MQ28-M
40	CQ-L050	CQ-F050	MQ-D050	

Note 1) When ordering a foot bracket, order 2 pcs. for each cylinder.

Note 2) The following parts are included with a bracket respectively.

Foot, Flange Body mounting bolts
Double clevis Clevis pin, C type retaining ring for shaft, Body mounting bolts

Specifications: Standard Type/MQQT



Bore size (mm)	10	16	20	25	30	40
Seal construction	Metal seal					
Action	Double acting, Single rod					
Fluid	Air					
Proof pressure	1.05 MPa					
Maximum operating pressure	0.5 MPa					
Minimum operating pressure <small>Note 1)</small>	0.005 MPa					
Ambient and fluid temperature	-10 to 80°C					
Cushion	Rubber bumper (Standard)					
Lubrication <small>Note 2)</small>	Not required (Non-lube)					
Rod end thread	Female thread					
Stroke length tolerance	+1.0 0					
Piston speed <small>Note 3)</small>	0.3 to 300 mm/s (Refer to page 340.)					
Total leakage <small>Note 4)</small>	Supply pressure 0.1 MPa	150 cm ³ /min	200 cm ³ /min	300 cm ³ /min	400 cm ³ /min	
	Supply pressure 0.3 MPa	800 cm ³ /min	1000 cm ³ /min	1200 cm ³ /min	1600 cm ³ /min	
	Supply pressure 0.5 MPa	1500 cm ³ /min	2000 cm ³ /min	3000 cm ³ /min	4000 cm ³ /min	

Note 1) Value when horizontal. (Use clean, dry, and nonfreezing air) However, as the stroke increases, it will likely be affected by the mass of its moving parts and the pressure will likely increase by approx. 0.003 to 0.005 MPa due to an offset load from the mass of the rod.

Note 2) Refer to precautions on page 339 regarding lubrication. This product uses turbine oil as an initial lubricant. Lubricant may seep out of the rod or the piping port.

Note 3) Control low speed actuation with differential pressure and a speed controller, etc. (Refer to recommended circuit examples on page 319 for further details.)

Note 4) The values are only for reference and are not guaranteed.

Symbol

Double acting, Single rod

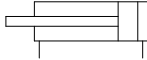

Specifications: Lateral Load Resisting Type/MQQL

Bore size (mm)	10	16	20	25	30	40
Seal construction	Metal seal					
Action	Double acting, Single rod					
Fluid	Air					
Proof pressure	1.05 MPa					
Maximum operating pressure	0.7 MPa					
Minimum operating pressure <small>Note 1)</small>	0.005 MPa					
Ambient and fluid temperature	-10 to 80°C					
Cushion	Rubber bumper (Standard)					
Lubrication <small>Note 2)</small>	Not required (Non-lube)					
Rod end thread	Female thread					
Stroke length tolerance	+1.0 0					
Piston speed <small>Note 3)</small>	0.5 to 500 mm/s (Refer to page 340.)					
Total leakage <small>Note 4)</small>	Supply pressure 0.1 MPa	150 cm ³ /min	200 cm ³ /min	300 cm ³ /min	400 cm ³ /min	
	Supply pressure 0.3 MPa	800 cm ³ /min	1000 cm ³ /min	1200 cm ³ /min	1600 cm ³ /min	
	Supply pressure 0.5 MPa	1500 cm ³ /min	2000 cm ³ /min	3000 cm ³ /min	4000 cm ³ /min	

Note 1) Value when horizontal. (Use clean, dry, and nonfreezing air) However, as the stroke increases, it will likely be affected by the mass of its moving parts and the pressure will likely increase by approx. 0.003 to 0.005 MPa due to an offset load from the mass of the rod.

Note 2) Refer to precautions on page 339 regarding lubrication. This product uses turbine oil as an initial lubricant. Lubricant may seep out of the rod or the piping port.

Note 3) Control low speed actuation with differential pressure and a speed controller, etc. (Refer to recommended circuit examples on page 319 for further details.)

Note 4) The values are only for reference and are not guaranteed.

Weight: Standard Type/MQQT

Bore size (mm)	Cylinder stroke (mm)							Unit: g
	10	20	30	40	50	60	75	
10	94	118	142	166	—	—	—	—
16	166	206	246	286	326	366	—	—
20	228	290	352	414	476	538	—	—
25	395	487	579	671	763	—	993	1223
30	479	567	655	743	831	—	1052	1272
40	728	846	964	1082	1200	—	1495	1790

Weight: Lateral Load Resisting Type/MQQL (Built-in Ball Bushing)

Bore size (mm)	Cylinder stroke (mm)							Unit: g
	10	20	30	40	50	60	75	
10	148	172	196	220	—	—	—	—
16	284	324	364	404	444	484	—	—
20	383	445	507	569	631	693	—	—
25	552	644	736	828	920	—	1150	1380
30	911	999	1087	1175	1263	—	1485	1705
40	1337	1455	1573	1691	1809	—	2104	2359

* Refer to page 340 for moving parts mass.

Theoretical Output (Guide)



Bore size (mm)	Rod size (mm)	Direction	Piston area (mm ²)	Operating pressure (MPa)						
				0.1	0.2	0.3	0.4	0.5	0.6	0.7
10	6	IN	50.3	5.0	10.1	15.1	20.1	25.2	30.2	35.2
		OUT	78.5	7.9	15.7	23.6	31.4	39.3	47.1	55.0
16 (15.8)	8	IN	145.8	14.9	29.2	43.7	58.3	72.9	87.5	102.1
		OUT	196.1	19.6	39.2	58.9	78.4	98.1	117.7	137.3
20	10	IN	235.6	23.6	47.1	70.7	94.2	117.8	141.4	164.9
		OUT	314.2	31.4	62.8	94.3	125.7	157.1	188.5	219.9
25	12	IN	377.8	37.8	75.6	113.3	151.1	188.9	226.7	262.5
		OUT	490.9	49.1	98.2	147.3	196.4	245.5	294.5	343.6
30	16	IN	505.8	50.6	101.2	151.8	202.4	253.0	303.6	354.2
		OUT	706.9	70.7	141.4	212.1	282.8	353.5	424.2	494.9
40	16	IN	1055.6	105.6	211.2	316.8	422.4	528.0	633.6	739.2
		OUT	1256.6	125.7	251.4	377.1	502.8	628.5	754.2	879.9

REA

REB

REC

Smooth

Low Speed

MQ

RHC

RZQ

D-□

X-□

MQQ Series

Construction

Standard type: MQQT

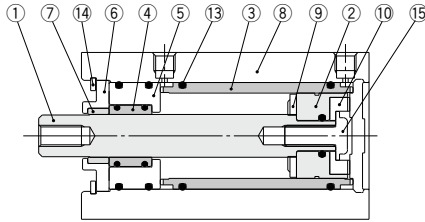

Lateral load resisting type: MQQL (Built-in ball bushing)

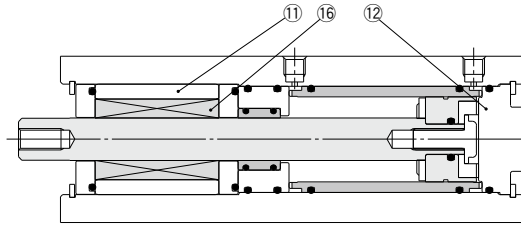

Component Parts

No.	Description	Material	Note
1	Rod	Carbon steel	Hard chrome plated
2	Piston	Special stainless steel	
3	Liner	Special stainless steel	
4	Sleeve	Special stainless steel	
5	Sleeve retainer	Aluminum alloy	
6	Plate	Aluminum alloy	Hard anodized
7	Guide	Fluororesin	
8	Cylinder tube	Aluminum alloy	Hard anodized
9	Bumper A	Polyurethane	
10	Bumper B	Polyurethane	
11	Bushing	Aluminum alloy	
12	Bottom plate	Aluminum alloy	Hard anodized
13	O-ring	NBR	
14	Retaining ring	Carbon tool steel	Phosphate coated
15	Bolt	Carbon tool steel	Chromated
16	Ball bushing		

Mounting

Mounting bolts

a) Mounting type A (when using the mounting plate threads)

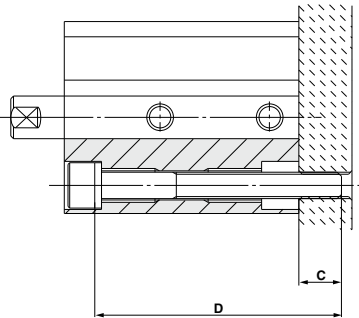

Note) Be sure to use a flat washer for the A type mounting.

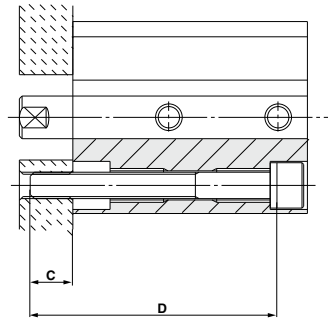

b) Mounting type B (when using the cylinder tube threads)

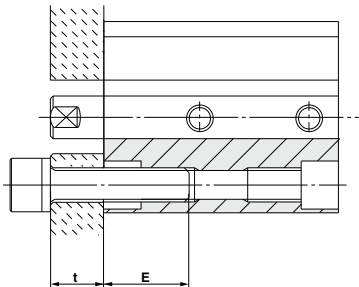
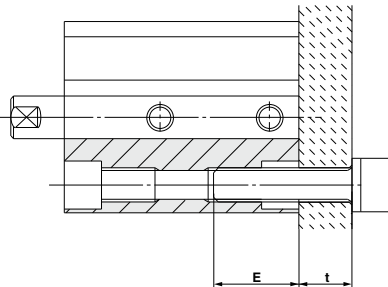

REA
REB
REC
Smooth
Low Speed
MQ
RHC
RZQ

Compatible Mounting Bolt Dimensions

Model	Mounting type A			Mounting type B		
	Mounting bolt size	C (mm)	D: Bolt length (mm)	Mounting bolt size	E (mm)	
Standard type MQQT	MQQT \square B10- \square D	M3 x 0.5	7	35 + Stroke	M4 x 0.7	8 to 11
	MQQT \square B16- \square D		7	35 + Stroke		
	MQQT \square B20- \square D	M5 x 0.8	8.5	40 + Stroke	M6 x 1	13 to 17
	MQQT \square B25- \square D		9	45 + Stroke		
	MQQT \square B30- \square D		7.5	50 + Stroke		
MQQT \square B40- \square D	M6 x 1	6	50 + Stroke	M8 x 1.25	16 to 22	
Lateral load resisting type MQQL (Built-in ball bushing)	MQQL \square B10- \square D	M3 x 0.5	7	65 + Stroke	M4 x 0.7	8 to 11
	MQQL \square B16- \square D		5.5	70 + Stroke		
	MQQL \square B20- \square D	M5 x 0.8	8	80 + Stroke	M6 x 1	13 to 17
	MQQL \square B25- \square D		6.5	85 + Stroke		
	MQQL \square B30- \square D		7	105 + Stroke		
	MQQL \square B40- \square D	M6 x 1	7	105 + Stroke	M8 x 1.25	16 to 22

\square : Stroke

D- \square
-X \square

MQQ Series

Dimensions

Standard type (Through hole & Double end tapped): MQQT B

ø10, ø16, ø20

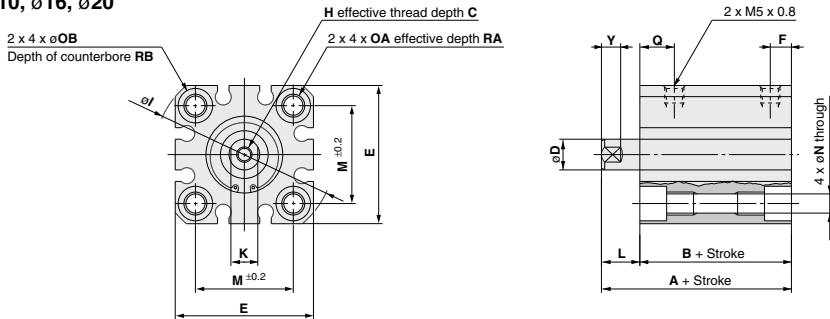

ø25, ø30, ø40

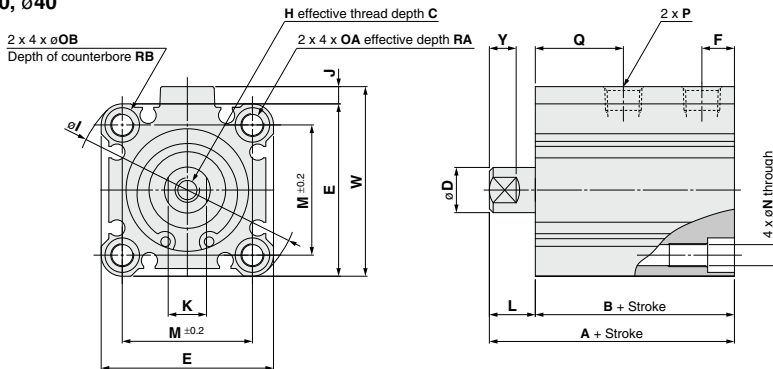

Bore size (mm)	Stroke range (mm)	A	B	C	D ^(Note)	E	F	H	I	J	K	L	M	N	OA	OB	P			Q	RA	RB	W	Y
																	—	TN	TF					
10	10 to 40	39.5	31.5	6	6 (5.8)	29	5.5	M3 x 0.5	38	—	5	8	20	3.5	M4 x 0.7	6.5	—	—	—	14.5	7	4	—	5
16	10 to 60	44	34	8	8 (7.8)	36	5.5	M4 x 0.7	47	—	7	10	25.5	5.4	M6 x 1.0	9	—	—	—	18	10	7	—	5
20	10 to 60	47.5	37.5	10	10 (9.8)	40	5.5	M5 x 0.8	52	—	8	10	28	5.4	M6 x 1.0	9	—	—	—	19.5	10	7	—	6
25	10 to 50, 75, 100	54	42	12	12 (11.8)	45	8.5	M6 x 1.0	60	4.5	10	12	34	5.5	M6 x 1.0	9	Rc 1/8	NPT 1/8	G 1/8	23	10	7	49.5	7
30	10 to 50, 75, 100	60.5	48.5	13	16 (15.8)	52	8.5	M8 x 1.25	69	5	14	12	40	5.5	M6 x 1.0	9	Rc 1/8	NPT 1/8	G 1/8	26	10	7	57	10
40	10 to 50, 75, 100	62	50	13	16 (15.8)	64	12	M8 x 1.25	86	7	14	12	50	6.6	M8 x 1.25	11	Rc 1/4	NPT 1/4	G 1/4	26	14	8	71	10

Note () : Rod end dimensions

With rod end male thread: MQQ□-□DM

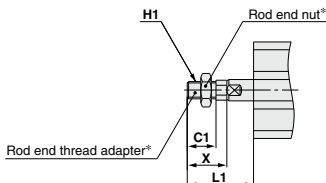

Bore size (mm)	L1	C1	H1	X
10	23.5	10.5	M5 x 0.8	15.5
16	26.5	11.5	M6 x 1.0	16.5
20	28.5	13.5	M8 x 1.25	18.5
25	34.5	16.5	M10 x 1.25	22.5
30	40.5	22.5	M14 x 1.5	28.5
40	40.5	22.5	M14 x 1.5	28.5

* Refer to page 330 for details regarding the rod end thread adapter and the rod end nut.

Foot type: MQQTL
ø10, ø16, ø20

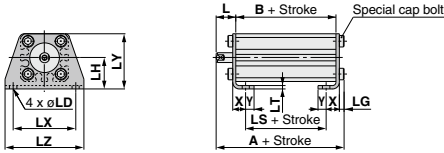

ø25, ø30, ø40

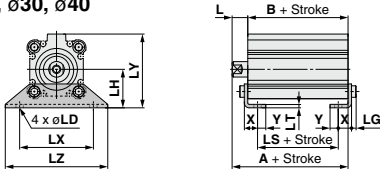

Bore size (mm)	Stroke range (mm)	A	B	L	LD	LG	LH
10	10 to 40	44.3	31.5	8	4.5	2.8	19
16	10 to 60	51.2	34	10	6.6	4	24
20	10 to 60	54.7	37.5	10	6.6	4	26
25	10 to 50,75,100	61.2	42	12	6.6	4	30
30	10 to 50,75,100	67.7	48.5	12	6.6	4	33
40	10 to 50,75,100	70.2	50	12	9	5	39

Bore size (mm)	LS	LT	LX	LY	LZ	X	Y
10	19.5	2	38	33.5	48	8	5
16	22	3.2	48	42	62	9.2	5.8
20	22.5	3.2	52	46	66	10.7	5.8
25	26	3.2	57	57	71	11.2	5.8
30	32.5	3.2	64	64	78	11.2	7
40	27	3.2	79	78	95	14.7	8

Rod side flange type: MQQTF
ø10, ø16, ø20

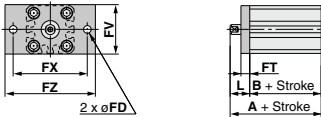

ø25, ø30, ø40

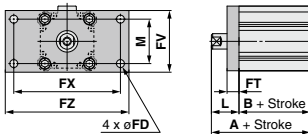

Bore size (mm)	Stroke range (mm)	A	B	FD	FT	FV	FX
10	10 to 40	49.5	31.5	4.5	5.5	30	45
16	10 to 60	54	34	6.6	8	39	48
20	10 to 60	57.5	37.5	6.6	8	42	52
25	10 to 50,75,100	64	42	5.5	8	48	56
30	10 to 50,75,100	70.5	48.5	5.5	8	54	62
40	10 to 50,75,100	72	50	6.6	9	67	76

Bore size (mm)	FZ	L	M
10	55	18	—
16	60	20	—
20	64	20	—
25	65	22	34
30	72	22	40
40	89	22	50

Head side flange type: MQQTG
ø10, ø16, ø20

ø25, ø30, ø40

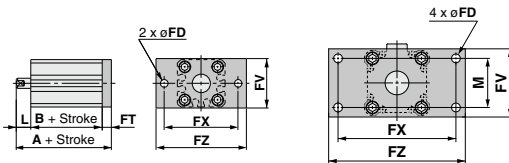

Bore size (mm)	Stroke range (mm)	A	L
10	10 to 40	45	8
16	10 to 60	52	10
20	10 to 60	55.5	10
25	10 to 50,75,100	62	12
30	10 to 50,75,100	68.5	12
40	10 to 50,75,100	70	12

(Dimensions other than A and L are the same as the rod side flange type.)

REA

REB

REC

Smooth

Low Speed

MQ

RHC

RZQ

MQQ Series

Dimensions

Lateral load resisting type (Through hole & Double end tapped): MQQLB

ø10, ø16, ø20

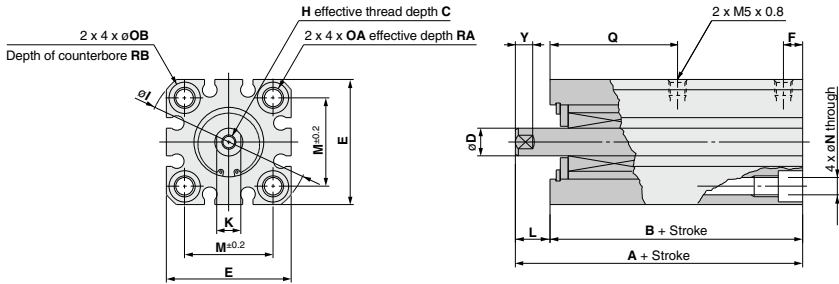

ø25, ø30, ø40

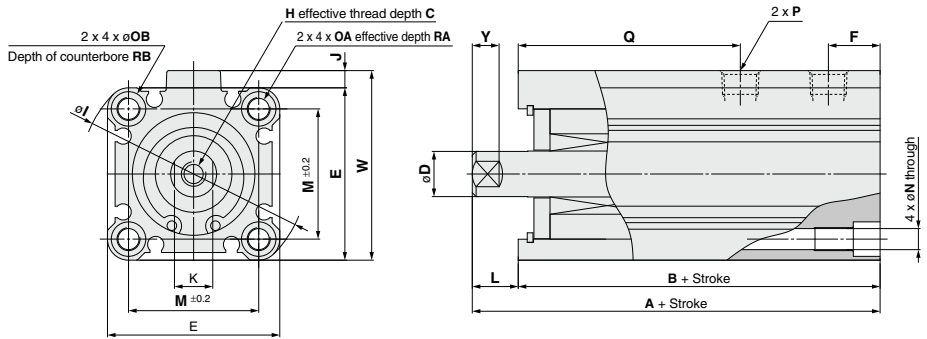

Bore size (mm)	Stroke range (mm)	A	B	C	D (Note)		E	F	H	I	J	K	L	M	N	OA	OB	P			Q	RA	RB	W	Y
					—	TN												TF							
10	10 to 40	69.5	61.5	6	6 (5.8)	29	9	M3 x 0.5	38	—	5	8	20	3.5	M4 x 0.7	6.5	—	—	—	39.5	7	4	—	5	
16	10 to 60	80.5	70.5	8	8 (7.8)	36	11	M4 x 0.7	47	—	7	10	25.5	5.4	M6 x 1.0	9	—	—	—	48.5	10	7	—	5	
20	10 to 60	89	79	10	10 (9.8)	40	11.5	M5 x 0.8	52	—	8	10	28	5.4	M6 x 1.0	9	—	—	—	55	10	7	—	6	
25	10 to 50, 75, 100	96.5	84.5	12	12 (11.8)	45	13.5	M6 x 1.0	60	4.5	10	12	34	5.5	M6 x 1.0	9	Rc 1/8	NPT 1/8	G 1/8	58	10	7	49.5	7	
30	10 to 50, 75, 100	116	104	13	16 (15.8)	52	17.5	M8 x 1.25	69	5	14	12	40	5.5	M6 x 1.0	9	Rc 1/8	NPT 1/8	G 1/8	71	10	7	57	10	
40	10 to 50, 75, 100	116	104	13	16 (15.8)	64	17.5	M8 x 1.25	86	7	14	12	50	6.6	M8 x 1.25	11	Rc 1/4	NPT 1/4	G 1/4	71	14	8	71	10	

Note () : Rod end dimensions

With rod end male thread: MQQ□-DM

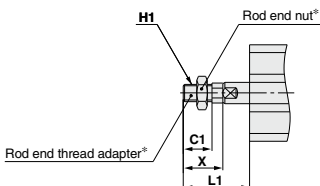

Bore size (mm)	(mm)			
	L1	C1	H1	X
10	23.5	10.5	M5 x 0.8	15.5
16	26.5	11.5	M6 x 1.0	16.5
20	28.5	13.5	M8 x 1.25	18.5
25	34.5	16.5	M10 x 1.25	22.5
30	40.5	22.5	M14 x 1.5	28.5
40	40.5	22.5	M14 x 1.5	28.5

* Refer to page 330 for details regarding the rod end thread adapter and the rod end nut.

Foot type: MQQLL
ø10, ø16, ø20

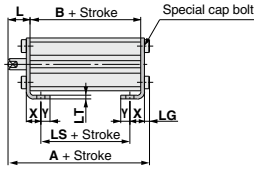
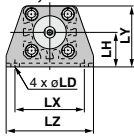

ø25, ø30, ø40

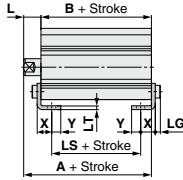
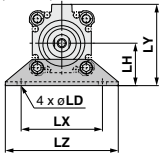

Rod side flange type: MQQLF
ø10, ø16, ø20

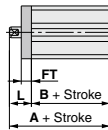
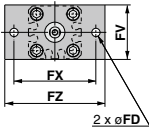

ø25, ø30, ø40

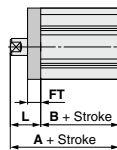
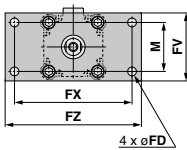

Head side flange type: MQQLG
ø10, ø16, ø20

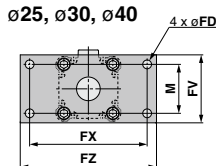
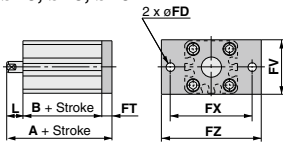

Double clevis type: MQQLD

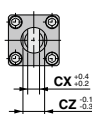
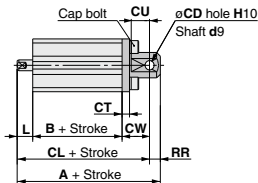

(mm)							
Bore size (mm)	Stroke range (mm)	A	B	L	LD	LG	LH
10	10 to 40	74.3	61.5	8	4.5	2.8	19
16	10 to 60	87.7	70.5	10	6.6	4	24
20	10 to 60	96.2	79	10	6.6	4	26
25	10 to 50,75,100	103.7	84.5	12	6.6	4	30
30	10 to 50,75,100	123.2	104	12	6.6	4	33
40	10 to 50,75,100	124.2	104	12	9	5	39

Bore size (mm)	LS	LT	LX	LY	LZ	X	Y
10	49.5	2	38	33.5	48	8	5
16	58.5	3.2	48	42	62	9.2	5.8
20	64	3.2	52	46	66	10.7	5.8
25	68.5	3.2	57	57	71	11.2	5.8
30	88	3.2	64	64	78	11.2	7
40	81	3.2	79	78	95	14.7	8

(mm)							
Bore size (mm)	Stroke range (mm)	A	B	FD	FT	FV	FX
10	10 to 40	79.5	61.5	4.5	5.5	30	45
16	10 to 60	90.5	70.5	6.6	8	39	48
20	10 to 60	99	79	6.6	8	42	52
25	10 to 50,75,100	106.5	84.5	5.5	8	48	56
30	10 to 50,75,100	126	104	5.5	8	54	62
40	10 to 50,75,100	126	104	6.6	9	67	76

Bore size (mm)	FZ	L	M
10	55	18	—
16	60	20	—
20	64	20	—
25	65	22	34
30	72	22	40
40	89	22	50

(mm)			
Bore size (mm)	Stroke range (mm)	A	L
10	10 to 40	75	8
16	10 to 60	88.5	10
20	10 to 60	97	10
25	10 to 50,75,100	104.5	12
30	10 to 50,75,100	124	12
40	10 to 50,75,100	124	12

(Dimensions other than A and L are the same as the rod side flange type.)

(mm)							
Bore size (mm)	Stroke range (mm)	A	B	CD	CL	CT	CU
10	10 to 40	90.5	61.5	5	84.5	4	10
16	10 to 60	107.5	70.5	8	98.5	5	12
20	10 to 60	119	79	10	109	5	14
25	10 to 50,75,100	126.5	84.5	10	116.5	5	14
30	10 to 50,75,100	148	104	10	138	6	14
40	10 to 50,75,100	158	104	14	144	7	20

Bore size (mm)	CW	CX	CZ	L	RR
10	15	6.5	12	8	6
16	18	8	16	10	9
20	20	10	20	10	10
25	20	18	36	12	10
30	22	18	36	12	10
40	28	22	44	12	14

REA

REB

REC

Smooth

Low Speed

MQ

RHC

RZQ

D-□

-X□

MQQ Series

Accessory Dimensions

Rod end thread adapter (With rod end nut shown in the right figure)

Rod end nut

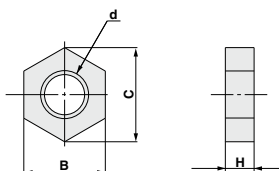
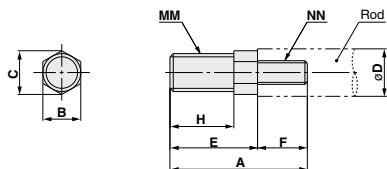

Material: Stainless steel

Part no.	Applicable bore size (mm)	A	B	C	D	E	F
MQ10-M	10	20.5	8	9.2	6	15.5	5
MQ16-M	16	22.5	8	9.2	8	16.5	6
MQ20-M	20	24.5	8	9.2	10	18.5	6
MQ25-M	25	33.5	10	11.5	12	22.5	11
MQ28-M	30, 40	40.5	14	16	16	28.5	12

Material: Carbon steel

Part no.	Applicable bore size (mm)	B	C	d	H	Weight
NTJ-015C	10	8	9.2	M5 x 0.8	4	1.5 g
NT-015A	16	10	11.5	M6 x 1.0	5	2.5 g
NT-02	20	13	15	M8 x 1.25	5	4.0 g
NT-03	25	17	19.6	M10 x 1.25	6	8.0 g
NT-04	30, 40	22	25.4	M14 x 1.5	8	17.0 g

Part no.	Applicable bore size (mm)	H	MM	NN	Weight (Note)
MQ10-M	10	10.5	M5 x 0.8	M3 x 0.5	5.5 g
MQ16-M	16	11.5	M6 x 1.0	M4 x 0.7	7.5 g
MQ20-M	20	13.5	M8 x 1.25	M5 x 0.8	11.5 g
MQ25-M	25	16.5	M10 x 1.25	M6 x 1.0	22.5 g
MQ28-M	30, 40	22.5	M14 x 1.5	M8 x 1.25	52.0 g

Note) Rod end nut is included

Clevis pin

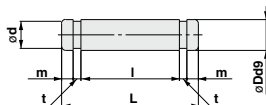

Material: Carbon steel

Part no.	Applicable bore size (mm)	Dd9	L	d	l	m	t	Applicable retaining ring
IY-J015	10	5 ^{-0.030} _{-0.040}	16.6	4.8	12.2	1.5	0.7	C type 5 for shaft
IY-G02	16	8 ^{-0.040} _{-0.076}	21	7.6	16.2	1.5	0.9	C type 8 for shaft
IY-G03	20	10 ^{-0.040} _{-0.076}	25.6	9.6	20.2	1.55	1.15	C type 10 for shaft
IY-G04	25, 30	10 ^{-0.040} _{-0.076}	41.6	9.6	36.2	1.55	1.15	C type 10 for shaft
IY-G05	40	14 ^{-0.050} _{-0.093}	50.6	13.4	44.2	2.05	1.15	C type 14 for shaft

* C-type retaining ring for shaft is included.

Metal Seal

Lateral Load Resisting Low Friction Cylinder

MQM Series

ø6, ø10, ø16, ø20, ø25



How to Order

MQML B 10 [] [] - 15 D

Lateral load resisting low friction specification

Type

L Lateral load resisting type (Built-in ball bushing)

Mounting

B	Basic type
L	Foot type
F	Rod side flange type
G	Head side flange type (Except for ø6)
C ^{Note 1)}	Single clevis type (Non-integrated type)
D ^{Note 2)}	Double clevis type

Note 1) Bore size: 20, 25 mm only

* Mounting brackets are included when shipped, but unassembled. (Except for clevis type.)

Note 2) ø6, ø10, ø16 Integrated type
ø20, ø25 Non-integrated type

Bore size

6	6 mm
10	10 mm
16	16 mm
20	20 mm
25	25 mm

Action

D Double acting

Cylinder stroke

Bore size (mm)	Standard stroke (mm)
6	15, 30, 45, 60
10	15, 30, 45, 60, 75, 100
16	15, 30, 45, 60, 75, 100
20	15, 30, 45, 60, 75, 100
25	15, 30, 45, 60, 75, 100

* Strokes are available in 1mm increments by installing spacers in standard stroke cylinders.

Example: MQMLB10-20D

(10 mm width spacer is installed in MQMLB10-30D to adjust the stroke.)

Function

Nil	Standard type
H ^{Note)}	High speed/high frequency type (Without fixed orifice)

Note) Except for 6 mm bore size.

Port thread type

Nil	M thread	ø6 to ø16
	Rc	
TN	NPT	ø20, ø25
TF	G	

* The MQM series is not auto switch capable.

Mounting Type/Accessories

Mounting bracket		B: Basic	L: Foot	F: Rod side flange	G: Head side flange	C: Single clevis	D: Double clevis	Note
Standard	Mounting nut ^{Note 1)}	● (1 pc.)	● (2 pcs.)	● (1 pc.)	● (1 pc.)	— ^{Note 1)}	— ^{Note 2)}	
	Rod end nut	●	●	●	●	●	●	
	Clevis pin	—	—	—	—	—	●	
Option	T-bracket	—	—	—	—	—	●	With pin

Note 1) Mounting nut is not included with the integrated clevis, single clevis and double clevis types.

Note 2) Pin and retaining ring are packed with the double clevis type.

Mounting Bracket Part No.

Bore size (mm)	Foot ^{Note 1)}	Flange	Single clevis	Double clevis (with pin) ^{Note 2)}	T-bracket ^{Note 3)}
6	CJK-L016C	CJK-F016C	—	—	CJ-T010C
10	MQM-L010		—	—	
16	MQM-L016	CLJ-F016B	—	—	CJ-T016C
20	CM-L020B	CM-F020B	CM-C020B	CM-D020B	—
25	CM-L032B	CM-F032B	CM-C032B	CM-D032B	—

Note 1-1) Bore size 6 mm:

1 foot bracket is included.

When ordering foot brackets, order 1 piece per a cylinder unit.

Note 1-2) Bore size other than 6 mm (10, 16, 20 and 25 mm) (Same as CM series):

2 foot brackets and 1 mounting nut (1 set) are used for a cylinder unit.

When ordering foot brackets, order 2 pieces per a cylinder unit (shipped as a set).

Note 2) Clevis pin and retaining ring are included in package.

Note 3) T-bracket is applicable to the double clevis type (D).

REA

REB

REC

Smooth

Low Speed

MQ

RHC

RZQ

D-□

-X□



Symbol

Double acting, Single rod

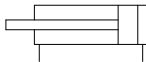

Specifications

Bore size (mm)		6	10	16	20	25
Seal construction		Metal seal				
Action		Double acting, Single rod				
Fluid		Air				
Proof pressure		1.05 MPa				
Maximum operating pressure		0.7 MPa				
Minimum operating pressure <small>Note 1)</small>	Standard type	0.02MPa	0.005 MPa			
	H (High speed/High frequency type)	—	0.01 MPa			
Ambient and fluid temperature		-10 to 80°C				
Cushion		Rubber bumper (Standard)				
Lubrication <small>Note 2)</small>		Not required (Non-lube)				
Stroke length tolerance		+1.0 0				
Piston speed <small>Note 3)</small>	Standard type	0.5 to 1000 mm/s (Refer to page 341.)				
	H (High speed/High frequency type)	—	5 to 3000 mm/s (Refer to page 341.)			
Total leakage <small>Note 4)</small>	Supply pressure 0.1 MPa	150 cm ³ /min	250 cm ³ /min	300 cm ³ /min	300 cm ³ /min	300 cm ³ /min
	Supply pressure 0.3 MPa	800 cm ³ /min	1000 cm ³ /min	1200 cm ³ /min	1200 cm ³ /min	1200 cm ³ /min
	Supply pressure 0.5 MPa	1500 cm ³ /min	2500 cm ³ /min	3000 cm ³ /min	3000 cm ³ /min	3000 cm ³ /min

Note 1) Value when horizontal. (Use clean, dry, and nonfreezing air) However, as the stroke increases, it will likely be affected by the mass of its moving parts and the pressure will likely increase by approx. 0.003 to 0.005 MPa due to an offset load from the mass of the rod.

Note 2) Refer to precautions on page 339 regarding lubrication. This product uses turbine oil (standard type) or lithium soap based grease (high speed/high frequency type) as an initial lubricant. Lubricant may seep out of the rod or the piping port.

Note 3) Control low speed actuation with differential pressure and a speed controller, etc. (Refer to recommended circuit examples on page 319 for further details.)

Note 4) The values are only for reference and are not guaranteed.

Weight: Standard Type, High Speed/High Frequency Type

Unit: g

Bore size (mm)	Cylinder stroke (mm)					
	15	30	45	60	75	100
6	52.5	60.7	68.9	77.1	—	—
10	92.4	102.7	113.0	123.3	133.6	143.9
16	152.4	175.2	198.0	220.8	243.6	266.4
20	349.8	392.6	435.4	478.2	521.0	563.8
25	460.8	510.0	559.2	608.4	657.6	706.8

* Refer to page 341 for moving parts mass.

Theoretical Output (Guide)



Unit: N

Bore size (mm)	Rod size (mm)	Direction	Piston area (mm ²)	Operating pressure (MPa)						
				0.1	0.2	0.3	0.4	0.5	0.6	0.7
6	4	IN	15.7	1.6	3.2	4.7	6.3	7.9	9.4	11.0
		OUT	28.3	2.8	5.7	8.5	11.3	14.2	17.0	19.8
10	4	IN	66.0	6.6	13.2	19.8	26.4	33.0	39.6	46.2
		OUT	78.5	7.9	15.7	23.6	31.4	39.3	47.1	55.0
16 (15.8)	5	IN	176.4	17.6	35.3	52.9	70.6	88.2	105.8	123.5
		OUT	196.1	19.6	39.2	58.9	78.4	98.1	117.8	137.3
20	8	IN	263.9	26.4	52.8	79.2	105.6	132.0	158.3	184.7
		OUT	314.2	31.4	62.8	94.3	125.7	157.1	188.5	219.9
25	10	IN	412.3	41.2	82.5	123.7	164.9	206.2	247.4	288.6
		OUT	490.9	49.1	98.2	147.3	196.4	245.5	294.5	343.6

Construction

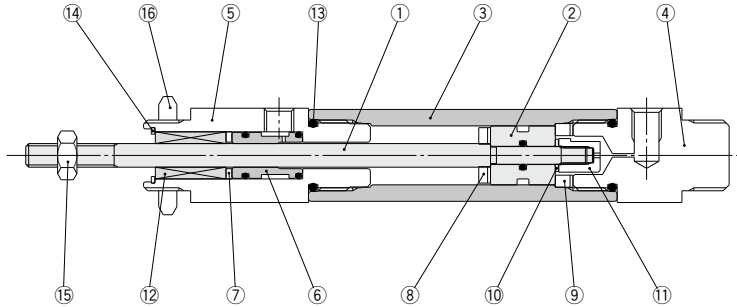

REA
REB
REC
Smooth
Low Speed
MQ
RHC
RZQ

Component Parts

No.	Description	Material	Note
1	Rod	Carbon steel	Hard chrome plated
2	Piston	Special stainless steel	
3	Tube	Special stainless steel	
4	Head cover	Aluminum alloy	Hard anodized
5	Rod cover	Aluminum alloy	Hard anodized
6	Sleeve	Special stainless steel	
7	Seat	NBR	
8	Bumper A	Polyurethane	
9	Bumper B	Polyurethane	
10	Bumper C	Polyurethane	
11	Nut	Aluminum alloy	
12	Ball bushing		
13	O-ring	NBR	
14	Retaining ring	Carbon tool steel	Phosphate coated
15	Rod end nut	Carbon steel	Chromated
16	Mounting nut	Brass/Carbon steel ^(Note)	

Note) Bore size: $\phi 6$, $\phi 10$, $\phi 16$Brass
Bore size: $\phi 20$, $\phi 25$Carbon steel

D-□
-X□

MQM Series

Dimensions

Basic type: MQMLB

ø6

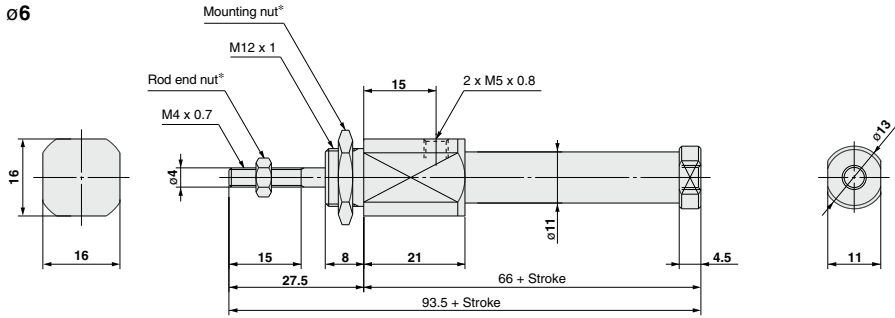

ø10, ø16, ø20, ø25

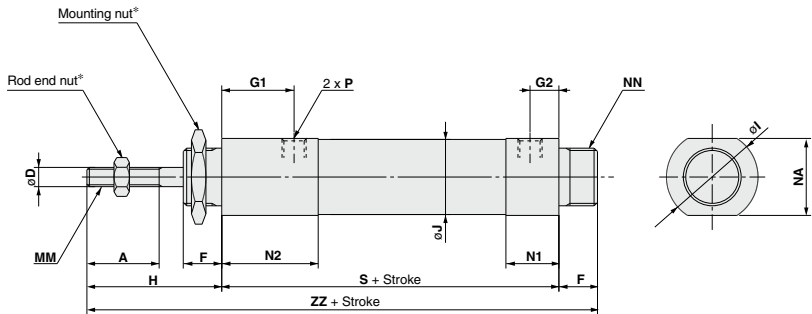

Bore size (mm)	A	D	F	G1	G2	H	I	J	MM	N1	N2	NA	NN	P			S	ZZ
														—	TN	TF		
10	15	4	8	15	6	28	18.5	16	M4 x 0.7	11	20	16	M12 x 1	M5 x 0.8	—	—	65	101
16	15	5	10	15	6	30	22	22	M5 x 0.8	12	21	19.5	M14 x 1	M5 x 0.8	—	—	74	114
20	18	8	13	25	8.5	40.5	31.5	28.5	M8 x 1.25	20.5	33	29	M20 x 1.5	Rc 1/8	NPT 1/8	G 1/8	97.5	151
25	18	10	13	30	8.5	44.5	34.5	32	M10 x 1.25	20.5	38	32	M26 x 1.5	Re 1/8	NPT 1/8	G 1/8	102.5	160

* Refer to page 338 for details regarding the rod end nut and the mounting nut.

Dimensions

Refer to the basic type on page 334 for other dimensions.

Foot type: MQMLL

ø6

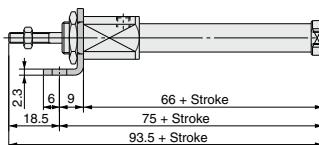
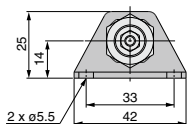

ø10, ø16, ø20, ø25

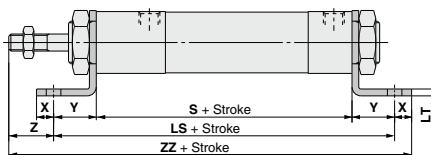
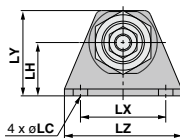

(mm)												
Bore size (mm)	LC	LH	LS	LT	LX	LY	LZ	S	X	Y	Z	ZZ
10	5.5	14	83	2.3	33	25	42	65	6	9	19	108
16	5.5	18	92	2.3	42	30	54	74	6	9	21	119
20	6.8	25	137.5	3.2	40	40	55	97.5	8	20	20.5	166
25	6.8	28	142.5	3.2	40	47	55	102.5	8	20	24.5	175

Rod side flange type: MQMLF

ø6

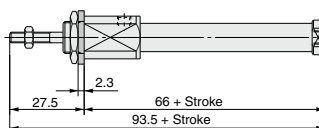
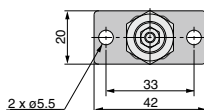

ø10, ø16, ø20, ø25

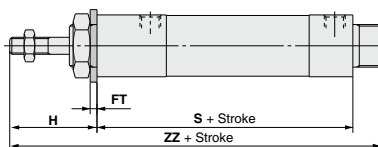
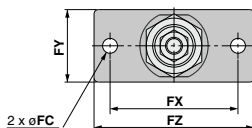

(mm)								
Bore size (mm)	FC	FT	FX	FY	FZ	H	S	ZZ
10	5.5	2.3	33	20	42	28	65	101
16	5.5	2.3	42	24	54	30	74	114
20	7	4	60	34	75	40.5	97.5	151
25	7	4	60	40	75	44.5	102.5	160

REA

REB

REC

Smooth

Low Speed

MQ

RHC

RZQ

D-□

-X□

MQM Series

Refer to the basic type on page 334 for other dimensions.

Dimensions

Head side flange type: MQMLG (Except for $\phi 6$)
 $\phi 10$, $\phi 16$, $\phi 20$, $\phi 25$

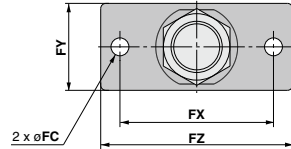
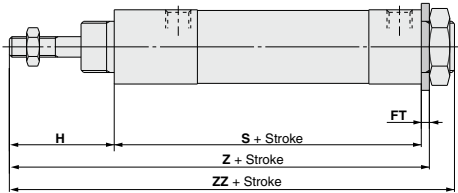

(mm)

Bore size (mm)	FC	FT	FX	FY	FZ	H	S	Z	ZZ
10	5.5	2.3	33	20	42	28	65	95.3	101
16	5.5	2.3	42	24	54	30	74	106.3	114
20	7	4	60	34	75	40.5	97.5	142	151
25	7	4	60	40	75	44.5	102.5	151	160

Single clevis type: MQMLC ($\phi 20$ and $\phi 25$ only)
 $\phi 20$, $\phi 25$ (Non-integrated type)

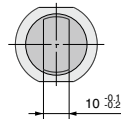
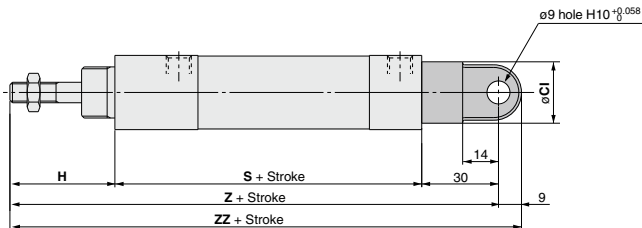

(mm)

Bore size (mm)	Cl	H	S	Z	ZZ
20	24	40.5	97.5	168	177
25	30	44.5	102.5	177	186

(Refer to the basic type on page 334 for other dimensions.)

Dimensions

Double clevis type: MQMLD ø6, ø10, ø16 (Integrated type)

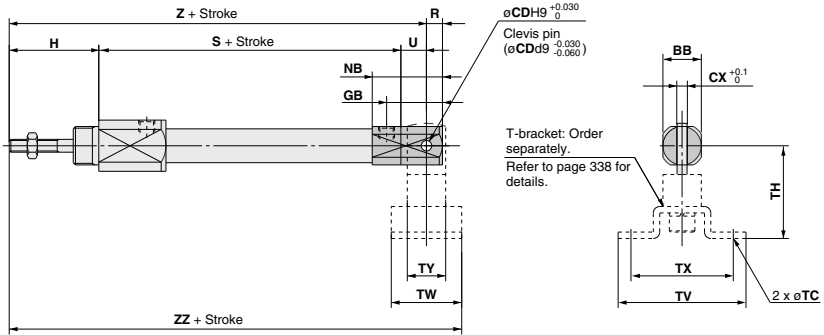

(mm)											
Bore size (mm)	BB	CD	CX	GB	H	NB	R	S	U	Z	ZZ
6	12	3.3	3.3	17.5	27.5	22	5	70.5	8	106	117
10	12	3.3	3.3	19	28	24	5	65	8	101	112
16	18	5	6.6	24	30	30	8	74	10	114	128

T-bracket Related Dimensions Note)

Part no.	Applicable bore size (mm)	TC	TH	TV	TW	TX	TY
CJ-T010C	6, 10	4.5	29	40	22	32	12
CJ-T016C	16	5.5	35	48	28	38	16

Note) Refer to page 338 for details.

ø20, ø25 (Non-integrated type)

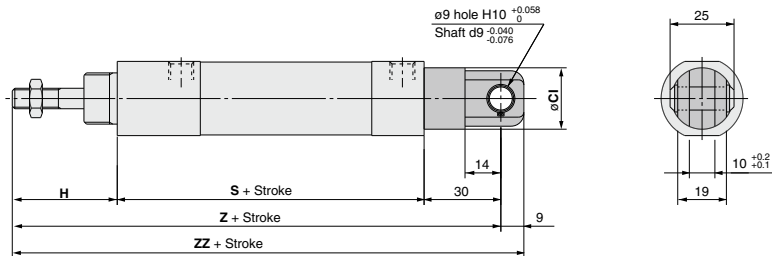

(mm)					
Bore size (mm)	CI	H	S	Z	ZZ
20	24	40.5	97.5	168	177
25	30	44.5	102.5	177	186

REA

REB

REC

Smooth

Low Speed

MQ

RHC

RZQ

D-□

-X□

Accessory Dimensions

Mounting nut

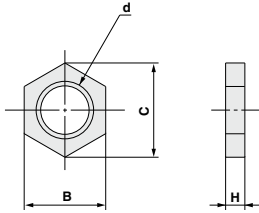

Part no.	Applicable bore size (mm)	B	C	d	H	Material
SNKJ-016C	6, 10	17	19.6	M12 x 1	4	Brass
SNLJ-016B	16	19	21.9	M14 x 1	5	Brass
SN-020B	20	26	30	M20 x 1.5	8	Carbon steel
SN-032B	25	32	37	M26 x 1.5	8	Carbon steel

Rod end nut

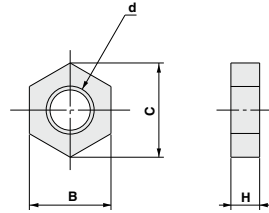

Material: Carbon steel

Part no.	Applicable bore size (mm)	B	C	D	H	Weight
NTJ-010C	6, 10	7	8.1	M4 x 0.7	3.2	1.0 g
NTJ-015C	16	8	9.2	M5 x 0.8	4	1.5 g
NT-02	20	13	15	M8 x 1.25	5	4.0 g
NT-03	25	17	19.6	M10 x 1.25	6	8.0 g

T-bracket

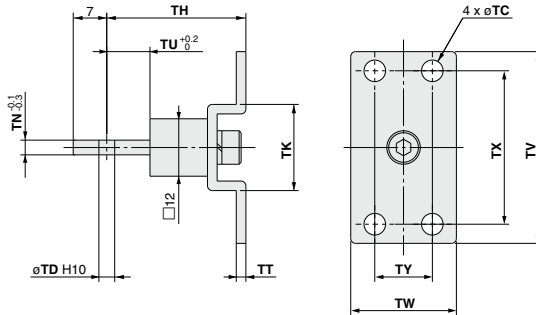

Part no.	Applicable bore size (mm)	TC	TD	TH	TK	TN	TT	TU	TV	TW	TX	TY
CJ-T010C	6, 10	4.5	3.3	29	18	3.1	2	9	40	22	32	12
CJ-T016C	16	5.5	5	35	20	6.4	2.3	14	48	28	38	16

Clevis pin

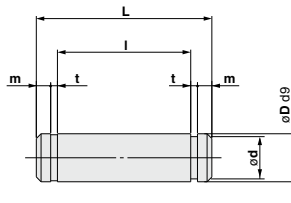

Part no.	Applicable bore size (mm)	d	D	l	L	m	t	Material	Applicable retaining ring
CD-J010	6, 10	3	3.3	12.2	15.2	1.2	0.3	Stainless steel	C type 3.2 for shaft
CD-2015	16	4.8	5	18.3	22.7	1.5	0.7	Stainless steel	C type 5 for shaft
CDP-1	20,25	8.6	9	19.2	25	1.75	1.15	Carbon steel	C type 9 for shaft

* C-type retaining ring for shaft is included.



MQQ/MQM Series

Specific Product Precautions 1

Be sure to read this before handling the products.

Refer to back page 50 for Safety Instructions and pages 3 to 12 for Actuator and Auto Switch Precautions.

Operation

Caution

1. When mounting, thoroughly flush out the connector piping and be sure that dirt and chips, etc., do not get inside the cylinder.
2. Install an air filter with a filtration degree of 5 μm or less on the air supply. Furthermore, when controlling for low speed or controlled output, use clean air (atmospheric pressure dew point temperature of -10°C). Installation of a mist separator (filtration degree 0.3 μm or less) is also recommended.

3. Use a metal seal type when using solenoid valves for cylinder actuation. If a rubber seal type is used, there may be an increase in operating resistance due to grease sprayed from the main valve.

4. Operate so that the load applied to the piston rod is normally in the axial direction.

In the event that a lateral load is unavoidable, do not exceed the range of the allowable lateral load at the rod end (refer to pages 340 and 341). (Use outside of the operating limits may cause an adverse effect on the life of the unit through problems such as looseness in the guide unit and a loss of precision.)

5. Take care not to scratch or gouge the sliding portion of the rod. This may cause malfunction or shorten the unit's life.

6. When attaching a work piece to the end of the rod, move the rod to the fully retracted position and use the wrench flats at the end of the rod. Fasten the work piece without applying a large amount of torque to the rod.

There are no wrench flats at the end of the rod in the MQM series, so use the attached rod end nut.

7. Be certain to connect a load so that the rod axis is aligned with the load and its direction of movement.

Especially when a cylinder rod is connected directly to a guide function (such as bearings, etc.) on the equipment side, the following is likely to occur. Either an offset load will occur and the sliding resistance will not be stable or galling will occur on the metal seal parts. Therefore, be sure to use a floating joint or a spherical joint.

8. When a piston rod is driven with a circuit from an external force such as force, control, tension control, etc., a stick-slip phenomenon will likely occur and sliding resistance will not be stable if the amount of displacement is 0.05 mm or less.

9. When it is used in locations where a constant vibration is applied, such as a polishing machine, etc., consult with us.

Disassembly

Caution

1. The component parts of the metal seal cylinder are manufactured to precision tolerances, and therefore cannot be disassembled.

Lubrication

Caution

1. Lubrication of non-lube type cylinder

Do not apply lubrication when controlling for low speed or controlled output. If lubrication is applied, there may be changes in operating resistance due to factors such as the viscosity and surface tension of the oil. Also, use a metal seal type when using solenoid valves for cylinder actuation. If a rubber seal type is used, there may be an increase in operating resistance due to grease sprayed from the main valve.

Lubrication is also unnecessary for high speed actuation, but in the event that lubrication is applied, use turbine oil class 1 (with no additives) ISO VG32. (Do not use spindle oil or machine oil.)

REA

REB

REC

Smooth

Low Speed

MQ

RHC

RZQ

D-□

-X□



MQQ/MQM Series Specific Product Precautions 2

Be sure to read this before handling the products.
Refer to back page 50 for Safety Instructions and pages 3 to 12 for Actuator and Auto Switch Precautions.

Selection

MQQ series

⚠ Caution Operating Speed

Load Mass and Maximum Speed: MQQT/MQQL

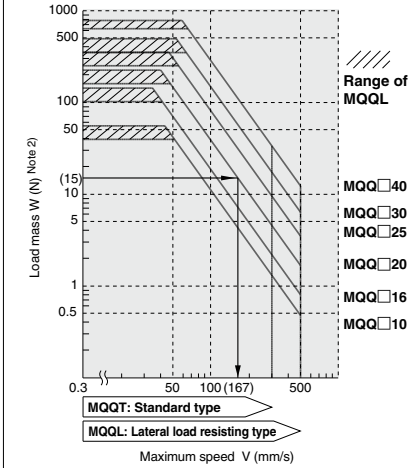

Example)
Driving a load of 15(N) using the MQQ□20 with a maximum speed of 167 (mm/sec)

Lateral load resisting type: MQQ□

Bore size (mm)	Allowable kinetic energy (J)
10	0.006
16	0.010
20	0.022
25	0.044
30	0.080
40	0.160

Note 1) When a load is attached to the rod end, adjust the speed so that the maximum speed is no more than that shown in the graph for the corresponding load mass.

Note 2) The mass of cylinder's moving parts is included in the load mass. (See the graph on the right.)

Moving Parts Mass

MQQ□ Moving Parts Mass

Bore size (mm)	MQQT□ Moving parts mass (g)	MQQL□ Moving parts mass (g)
10	Mass = 8.9 + (3.1 x (stroke/10))	Mass = 16.7 + (3.1 x (stroke/10))
16	Mass = 22.9 + (4.0 x (stroke/10))	Mass = 34.9 + (4.0 x (stroke/10))
20	Mass = 34.8 + (6.6 x (stroke/10))	Mass = 57.9 + (6.6 x (stroke/10))
25	Mass = 66.9 + (8.8 x (stroke/10))	Mass = 97.7 + (8.8 x (stroke/10))
30	Mass = 115.0 + (15.8 x (stroke/10))	Mass = 190.2 + (15.8 x (stroke/10))
40	Mass = 182.2 + (15.8 x (stroke/10))	Mass = 257.4 + (15.8 x (stroke/10))

Note) For the rod side flange type, add 10 mm to the stroke length of the MQQ□F

$$\text{Kinetic energy } E \text{ (J)} = \frac{(m1 + m2) V^2}{2}$$

m1 : Mass of cylinder movable parts kg
m2 : Load mass kg
V : Piston speed m/s

Allowable Lateral Load at Rod End

Standard Type: MQQTB

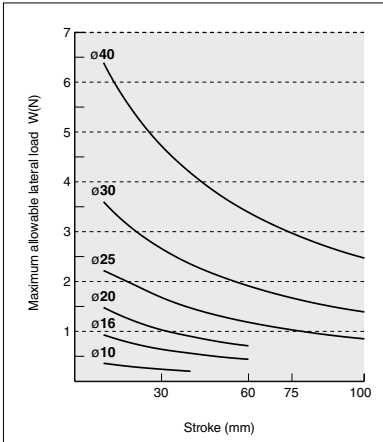

Lateral Load Resisting Type: MQQLB/Built-in Ball Bushing

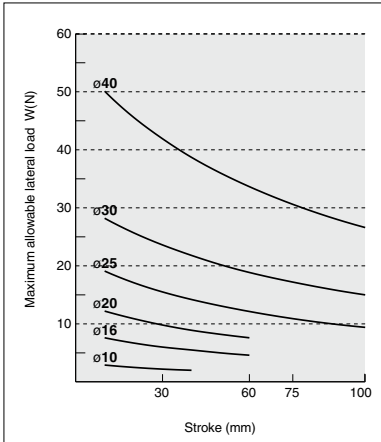

Note 1) The indicated allowable lateral load at the rod end is for the rod end female thread.

Note 2) The allowable lateral load varies depending on the size of a load (the distance to the load's center of gravity). Please contact SMC for further details.

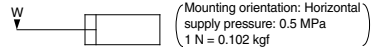



MQQ/MQM Series Specific Product Precautions 3

Be sure to read this before handling the products.

Refer to back page 50 for Safety Instructions and pages 3 to 12 for Actuator and Auto Switch Precautions.

Selection

MQM series

⚠ Caution Operating Speed

Load Mass and Maximum Speed: MQML/MQML□□H

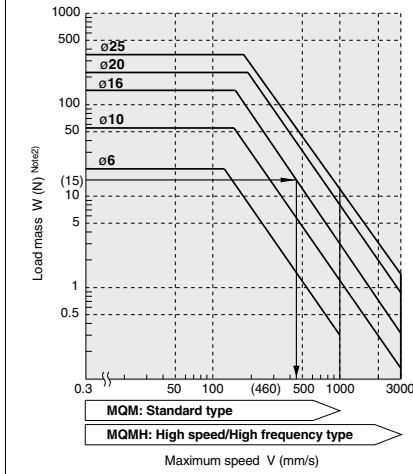

Example)
Driving a load of 15(N) using the MQM16 with a maximum speed of 460 (mm/sec)

Lateral load resisting type: MQML/MQML□□H

Bore size (mm)	Allowable kinetic energy (J)
6	0.015
10	0.059
16	0.161
20	0.386
25	0.597

Note 1) When a load is attached to the rod end, adjust the speed so that the maximum speed is no more than that shown in the graph for the corresponding load mass.

Note 2) The mass of cylinder's moving parts is included in the load mass. (See the graph on the right.)

Moving Parts Mass

MQM Moving Parts Mass

Bore size (mm)	Moving parts mass (g)
6	Mass = 8.2 + {1.6 x (stroke/15)}
10	Mass = 12.0 + {1.6 x (stroke/15)}
16	Mass = 28.6 + {2.2 x (stroke/15)}
20	Mass = 72.0 + {6.4 x (stroke/15)}
25	Mass = 117.6 + {9.2 x (stroke/15)}

Note) Rod end nut is not included in the moving parts mass.

$$\text{Kinetic energy } E \text{ (J)} = \frac{(m1 + m2) V^2}{2}$$

m1 : Mass of cylinder movable parts kg
m2 : Load mass kg
V : Piston speed m/s

Allowable Lateral Load at Rod End

Allowable Lateral Load at Rod End

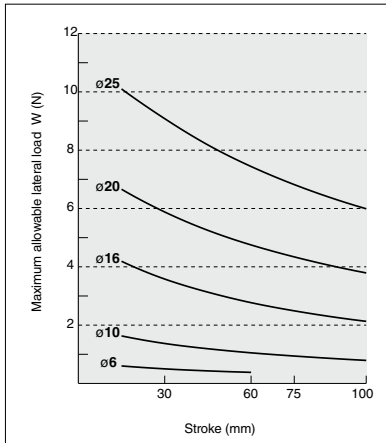

Note 1) The allowable lateral load varies depending on the size of a load (the distance to the load's center of gravity). Please contact SMC for further details.

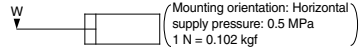

REA

REB

REC

Smooth

Low Speed

MQ

RHC

RZQ

D-□

-X□

Low Friction Cylinder (Single Acting)

MQP Series

ø4, ø6, ø10, ø16, ø20



How to Order

MQ P 10 - 10 S

- **Single acting specification**
- **Bore size**

4	4 mm
6	6 mm
10	10 mm
16	16 mm
20	20 mm
- **Action**

S	Special single acting (Piston retraction by external force)
---	---
- **Cylinder stroke**

10	10 mm
----	-------

* Cannot be used at the stroke end.

* The MQP series is not auto switch capable.

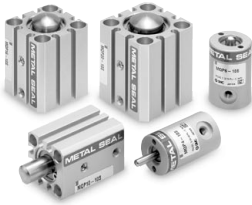

Symbol

Single acting (Pressing force)

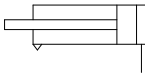

Specifications

Bore size (mm)	4	6	10	16	20
Seal construction	Metal seal				
Action	Special single acting (Piston retraction by external force)				
Proof pressure	1.05 MPa				
Maximum operating pressure	0.7 MPa				
Minimum operating pressure <small>Note 1)</small>	0.001 MPa				
Ambient and fluid temperature	+5 to +80°C				
Lubrication <small>Note 2)</small>	Not required (Non-lube)				
Stroke length tolerance	+1.0 0				
Total <small>Note 3)</small> leakage	Supply pressure 0.1 MPa	100 cm ³ /min			
	Supply pressure 0.3 MPa	500 cm ³ /min			
	Supply pressure 0.5 MPa	1000 cm ³ /min			

Note 1) Excluding the mass of moving parts.

Note 2) Refer to precautions on page 344 regarding lubrication. This product uses turbine oil as an initial lubricant. Lubricant may seep out of the rod or the piping port.

Note 3) The values are only for reference and are not guaranteed.

Moving Parts and Total Mass

Unit: g

Bore size (mm)	Moving parts mass	Total mass
4	4	43
6	8	55
10	24	96
16	62	161
20	103	239

Theoretical Output (Guide)

Unit: N

Bore size (mm)	Piston area (mm ²)	Operating pressure (MPa)						
		0.1	0.2	0.3	0.4	0.5	0.6	0.7
4	12.6	1.3	2.6	3.9	5.2	6.5	7.8	9.1
6	28.3	2.8	5.6	8.4	11.2	14.0	16.8	19.6
10	78.5	7.9	15.7	23.6	31.4	39.3	47.1	55.0
16	201.1	20.1	40.2	60.3	80.4	100.6	120.7	140.8
20	314.2	31.4	62.8	94.3	125.7	157.1	188.5	219.9

Construction

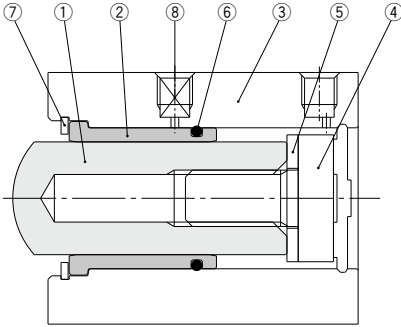

Component Parts

No.	Description	Material	Note
1	Piston rod	Special stainless steel	
2	Liner	Special stainless steel	
3	Cylinder tube	Aluminum alloy	Hard anodized
4	Bolt	Carbon tool steel	Chromated
5	Bumper	Polycarbonate	
6	O-ring	NBR	
7	Retaining ring	Carbon tool steel	Phosphate coated
8	Plug	Carbon tool steel	Chromated

REA

REB

REC

Smooth

Low Speed

MQ

RHC

RZQ

Dimensions

ø4, ø6

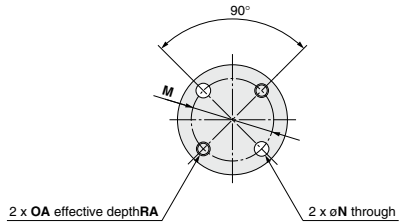
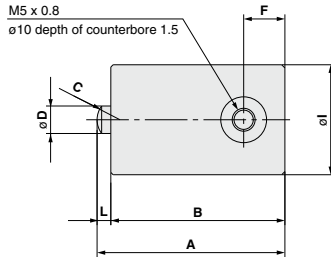

ø10, ø16, ø20

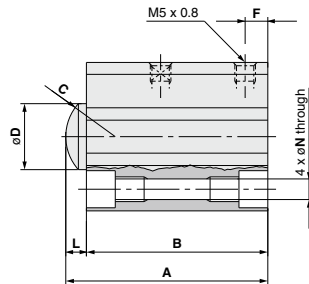
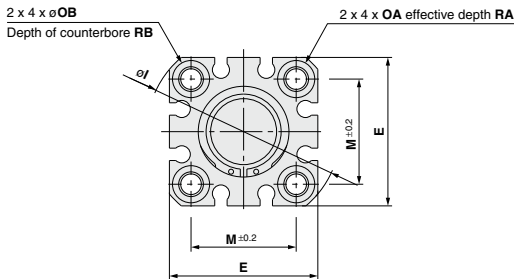

(mm)

Bore size (mm)	A	B	C	D ^{Note)}	E	F	I	L	M	N	OA	OB	RA	RB
4	41	38	SR3	4	—	9	22	3	16	3.2	M3 x 0.5	—	6	—
6	41	38	SR5	6	—	9	24	3	18	3.2	M3 x 0.5	—	6	—
10	46.5	41.5	SR8	10	29	5.5	38	5	20	3.5	M4 x 0.7	6.5	7	4
16	49	44	SR12	16	36	5.5	47	5	25.5	5.4	M6 x 1.0	9	10	7
20	52.5	47.5	SR15	20(19)	40	5.5	52	5	28	5.4	M6 x 1.0	9	10	7

Note) (): Rod end dimensions

D-□

-X□



MQP Series

Specific Product Precautions

Be sure to read this before handling the products.

Refer to back page 50 for Safety Instructions and pages 3 to 12 for Actuator and Auto Switch Precautions.

Operation

1. When mounting, thoroughly flush out the connector piping and be sure that dirt and chips, etc., do not get inside the cylinder.
2. Install an air filter with a nominal filtration degree of $5\ \mu\text{m}$ or less on the air supply. Furthermore, when controlling for low speed or controlled output, use clean air (atmospheric pressure dew point temperature of -10°C or less). Installation of a mist separator (nominal filtration degree $0.3\ \mu\text{m}$ or less) is also recommended.
3. Use a metal seal type when using solenoid valves for cylinder actuation. If a rubber seal type is used, there may be an increase in operating resistance due to grease sprayed from the main valve.
4. This cylinder cannot be used at the end of its stroke. Use it with an intermediate stroke of 10 mm.
5. The rod end should not come in direct contact with an equipment or workpiece. Also, make sure that the opposite side of the rod end is flat to make point-contact with the spherical surface of the rod end.

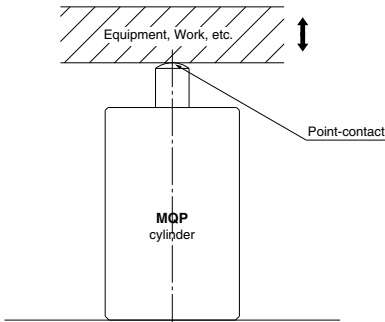

The material of the cylinder rod is heat-treated stainless steel (HRC60). The roughness of the spherical contact of the attaching part (Equipment, Work, etc) should be Rz6.3 and the material should be HB100 or greater (Aluminum material: 2000 line or 7000 line or equivalent) When higher precision or longer service life is required, we recommend using a heat-treated material + flat polished machined material (Rz0.8)

Also, although applying grease on the spherical contact parts will make the operation more smooth and reduce the abrasion, use caution to prevent any grease from being applied to the cylinder's sliding surface.

Operation

6. When connecting, be sure to align the rod axis with the load and the direction of movement.

The allowable angle of the cylinder's mounting surface in an equipment should be 3° or less.

(1° or less is recommended.) When not properly aligned, a lateral load will likely be applied to the rod and the spherical surface will likely skid. This will result in a reduction or dispersion of thrust and likely a malfunction.

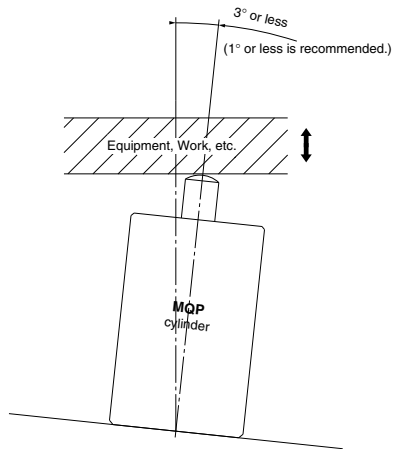

Disassembly

1. The component parts of the metal seal cylinder are manufactured to precision tolerances, and therefore cannot be disassembled.

Lubrication

1. Lubrication of non-lube type cylinder

Do not apply lubrication when controlling for low speed or controlled output. If lubrication is applied, there may be changes in operating resistance due to factors such as the viscosity and surface tension of the oil. Also, use a metal seal type when using solenoid valves for cylinder actuation. If a rubber seal type is used, there may be an increase in operating resistance due to grease sprayed from the main valve.

Lubrication is also unnecessary for high speed actuation, but in the event that lubrication is applied, use turbine oil class 1 (with no additives) ISO VG32. (Do not use spindle oil or machine oil.)