

Compact Guide Cylinder

MGQ Series

ø12, ø16, ø20, ø25, ø32, ø40, ø50, ø63, ø80, ø100

Air cylinder with guide integrated that has achieved anti-lateral load and high non-rotating accuracy.

Space-saving cylinder.
Suitable as stoppers or lifters in conveyor line.

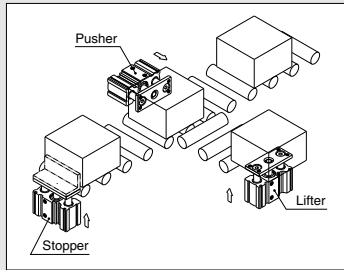

Cylinder position can be detected.

All models have built-in magnets for auto switches.



Two types of guide rod bearing for different applications

Slide bearing

Slide bearing Strength against side load is more than 2 times as compared current stopper cylinder (Compared to SMC RSQ series, round bar type).

Ball bushing bearing

Smooth operation is suitable for pushing, lifter and applications where high precision is required.

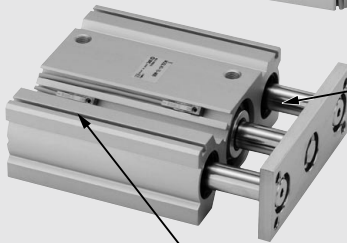

Non-rotating accuracy

Bore size (mm)	Non-rotating accuracy θ	
	MGQM	MGQL
12	$\pm 0.08^\circ$	$\pm 0.10^\circ$
16	$\pm 0.07^\circ$	$\pm 0.09^\circ$
20	$\pm 0.06^\circ$	$\pm 0.08^\circ$
25	$\pm 0.05^\circ$	$\pm 0.06^\circ$
32	$\pm 0.04^\circ$	$\pm 0.05^\circ$
40	$\pm 0.04^\circ$	$\pm 0.05^\circ$
50	$\pm 0.04^\circ$	$\pm 0.05^\circ$
63	$\pm 0.04^\circ$	$\pm 0.05^\circ$
80	$\pm 0.04^\circ$	$\pm 0.05^\circ$
100	$\pm 0.04^\circ$	$\pm 0.05^\circ$

Can be mounted from two directions

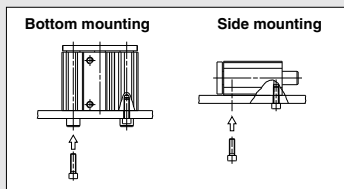

Auto switches, lead wires and terminals can be fixed in the groove of cylinder body.

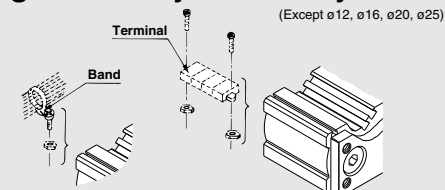

- MGJ
- JMGP
- MGP
- MGPW
- MGQ
- MGG
- MGC
- MGF
- MGZ
- MGT

- D-□
- X□

Compact Guide Cylinder

MGQ Series

ø12, ø16, ø20, ø25, ø32, ø40, ø50, ø63, ø80, ø100

How to Order

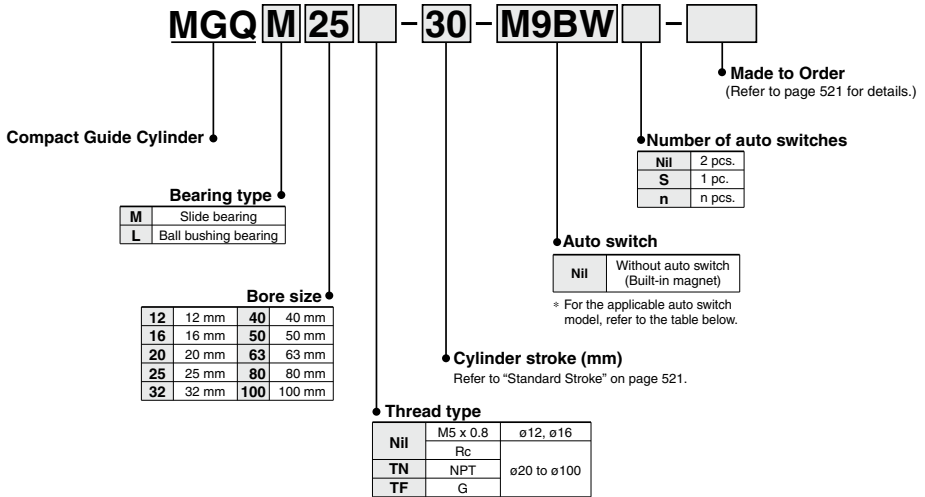

Applicable Auto Switches

Refer to pages 1119 to 1245 for further information on auto switches.

Type	Special function	Electrical entry	Indicator light	Wiring (Output)	Load voltage			Auto switch model		Lead wire length (m)				Pre-wired connector	Applicable load
					DC	AC		Perpendicular	In-line	0.5 (Nil)	1 (M)	3 (L)	5 (Z)		
Solid state auto switch	—	Grommet	Yes	3-wire (NPN)	24 V	—	M9NV	M9N	●	●	○	○	IC circuit	Relay, PLC	
				3-wire (PNP)			M9PV	M9P	●	●	○	○			
				2-wire			M9BV	M9B	●	●	●	○			
	3-wire (NPN)			M9NVW	M9NW	●	●	○	○						
	3-wire (PNP)			M9PVW	M9PW	●	●	○	○						
	2-wire			M9BWW	M9BWB	●	●	○	○						
Water resistant (2-color indicator)	Grommet	Yes	3-wire (NPN)	24 V	—	M9NAV *1	M9NA *1	○	○	●	○	IC circuit	Relay, PLC		
			3-wire (PNP)			M9PAV *1	M9PA *1	○	○	●	○				
			2-wire			M9BAV *1	M9BA *1	○	○	○	○				
Reed auto switch	—	Grommet	Yes	3-wire (NPN equivalent)	24 V	12 V	A96V	A96	●	—	●	—	IC circuit	—	
				No			2-wire	100 V	A93V *2	A93	●	●			●
						100 V or less	A90V	A90	●	—	●	—	—	IC circuit	

*1 Water resistant type auto switches can be mounted on the above models, but in such case SMC cannot guarantee water resistance.

Consult with SMC regarding water resistant types with the above model numbers.

*2 1 m type lead wire is only applicable to D-A93.

* Lead wire length symbols: 0.5 m Nil (Example) M9NV
 1 m M (Example) M9NVW
 3 m L (Example) M9NWL
 5 m Z (Example) M9NWX

* Solid state auto switches marked with "○" are produced upon receipt of order.

* Since there are other applicable auto switches than listed, refer to page 531 for details.

* For details about auto switches with pre-wired connector, refer to pages 1192 and 1193.

* Auto switches are shipped together (not assembled).

Air cylinder integrated with guide has achieved anti-lateral load and high non-rotating accuracy.

Space-saving and compact design

Suitable as stoppers or lifters in conveyor line

2 types of guide rod bearing are available depending upon the application

Slide bearing/Ball bushing bearing



Symbol
Rubberbumper

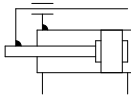

Made to Order: Individual Specifications
(For details, refer to pages 532 and 533.)

Symbol	Specifications
-X168	Helical insert thread
-X367	Bottom mounting type
-X399	Long bushing type
-X563	With anti-strong magnetic field switch (D-P4DW)

Made to Order Specifications

[Click here for details](#)

Symbol	Specifications
-XA□	Change of rod end shape
-XB6	Heat resistant cylinder (-10 to 150°C)
-XB9	Low speed cylinder (10 to 50 mm/s)
-XB10	Intermediate stroke (Using exclusive body)
-XC22	Fluororubber seals
-XC56	With knock pin holes
-XC79	Machining tapped hole, drilled hole, and pin hole additionally

Specifications

Bearing type	Slide bearing		Ball bushing bearing
Model	MGQM		MGQL
Bore size (mm)	12, 16, 20, 25, 32, 40, 50, 63, 80, 100		
Action	Double acting		
Fluid	Air		
Proof pressure	1.5 MPa		
Max. operating pressure	1.0 MPa		
Min. operating pressure	ø12, ø16	0.12 MPa	
	ø20 to ø100	0.1 MPa	
Ambient and fluid temperature	-10 to 60°C (No freezing)		
Piston speed	ø12 to ø63	50 to 500 mm/s	
	ø80, ø100	50 to 400 mm/s	
Cushion	Rubber bumper on both ends		
Lubrication	Non-lube		
Stroke length tolerance	+1.5 0 mm		

Standard Stroke

Model	Standard stroke (mm)	Intermediate stroke (mm)
MGQ $\frac{12}{16}$	10, 20, 30, 40, 50, 75, 100	As for the intermediate strokes other than the standard strokes at left are manufactured by means of installing a spacer. ø12 to ø32 Stroke available in 1 stroke increments ø40 to ø100 Stroke available in 5 stroke increments (Example) 1. For MGQM20-21 st, MGQM20-30 st is provided with a 5 mm + 4 mm ≤ 9 mm width spacer. 2. For MGQM50-40 st, MGQM50-50 st is provided with a 10 mm width spacer.
MGQ $\frac{16}{20}$	20, 30, 40, 50, 75, 100 125, 150, 175, 200	
MGQ $\frac{32, 40}{50, 63, 80, 100}$	25, 50, 75, 100, 125 150, 175, 200	

Theoretical Output



Bore size (mm)	Rod size (mm)	Operating direction	Piston area (mm ²)	Operating pressure (MPa)										
				0.2	0.3	0.4	0.5	0.6	0.7	0.8	0.9	1.0		
12	6	OUT	113	23	34	45	57	68	79	90	102	113		
		IN	85	17	26	34	43	51	60	68	77	85		
16	8	OUT	201	40	60	80	101	121	141	161	181	201		
		IN	151	30	45	60	76	91	106	121	136	151		
20	10	OUT	314	63	94	126	157	188	220	251	283	314		
		IN	236	47	71	94	118	142	165	189	212	236		
25	12	OUT	491	98	147	196	246	295	344	393	442	491		
		IN	378	76	113	151	189	227	265	302	340	378		
32	16	OUT	804	161	241	322	402	482	563	643	724	804		
		IN	603	121	181	241	302	362	422	482	543	603		
40	16	OUT	1257	251	377	503	629	754	880	1006	1131	1257		
		IN	1056	211	317	422	528	634	739	845	950	1056		
50	20	OUT	1963	393	589	785	982	1178	1374	1570	1767	1963		
		IN	1649	330	495	660	825	990	1154	1319	1484	1649		
63	20	OUT	3117	623	935	1247	1559	1870	2182	2494	2805	3117		
		IN	2803	561	841	1121	1402	1682	1962	2242	2523	2803		
80	25	OUT	5027	1005	1508	2011	2514	3016	3519	4022	4524	5027		
		IN	4536	907	1361	1814	2268	2722	3175	3629	4082	4536		
100	30	OUT	7854	1571	2356	3142	3927	4712	5498	6283	7069	7854		
		IN	7147	1429	2144	2859	3574	4288	5003	5718	6432	7147		

Note) Theoretical output (N) = Pressure (MPa) x Piston area (mm²)

MGJ

JMGF

MGP

MGPW

MGQ

MGG

MGC

MGF

MGZ

MGT

D-□

-X□

MGQ Series

Weight/Slide Bearing: MGQM12 to 100

(kg)

Bore size (mm)	Model	Standard stroke (mm)											
		10	20	25	30	40	50	75	100	125	150	175	200
12	MGQM12	0.23	0.27	—	0.31	0.34	0.38	0.48	0.58	—	—	—	—
16	MGQM16	0.34	0.39	—	0.45	0.50	0.55	0.68	0.80	—	—	—	—
20	MGQM20	—	0.54	—	0.61	0.69	0.76	0.94	1.09	1.24	1.39	1.54	1.69
25	MGQM25	—	0.83	—	0.93	1.04	1.13	1.44	1.68	1.92	2.16	2.40	2.64
32	MGQM32	—	—	1.51	—	—	1.91	2.29	2.69	3.09	3.49	3.89	4.29
40	MGQM40	—	—	1.65	—	—	2.24	2.46	2.87	3.28	3.69	4.10	4.51
50	MGQM50	—	—	2.54	—	—	3.09	3.65	4.21	4.77	5.33	5.89	6.45
63	MGQM63	—	—	3.01	—	—	3.63	4.23	4.85	5.47	6.09	6.71	7.33
80	MGQM80	—	—	5.66	—	—	6.59	7.49	8.41	9.33	10.25	11.17	12.09
100	MGQM100	—	—	8.96	—	—	10.27	11.57	12.90	14.23	15.56	16.89	18.22

Weight/Ball Bushing Bearing: MGQL12 to 100

(kg)

Bore size (mm)	Model	Standard stroke (mm)											
		10	20	25	30	40	50	75	100	125	150	175	200
12	MGQL12	0.23	0.26	—	0.29	0.35	0.38	0.46	0.53	—	—	—	—
16	MGQL16	0.35	0.39	—	0.44	0.52	0.57	0.70	0.82	—	—	—	—
20	MGQL20	—	0.54	—	0.60	0.70	0.75	0.90	1.04	1.18	1.32	1.46	1.60
25	MGQL25	—	0.84	—	0.93	1.08	1.17	1.37	1.58	1.79	2.00	2.21	2.42
32	MGQL32	—	—	1.32	—	—	1.67	2.09	2.45	2.81	3.17	3.53	3.89
40	MGQL40	—	—	1.46	—	—	1.82	2.27	2.63	2.99	3.35	3.71	4.07
50	MGQL50	—	—	2.11	—	—	2.59	3.19	3.68	4.17	4.66	5.15	5.64
63	MGQL63	—	—	2.65	—	—	3.19	3.85	4.39	4.93	5.47	6.01	6.55
80	MGQL80	—	—	5.49	—	—	6.38	7.95	8.79	9.63	10.47	11.31	12.15
100	MGQL100	—	—	8.34	—	—	9.53	11.78	12.96	14.14	15.32	16.50	17.68

Operating Conditions

Allowable Lateral Load (Ordinary load)

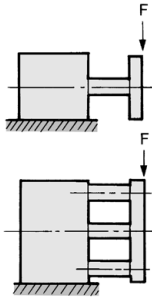

Bore size (mm)	Bearing type	Stroke (mm)											
		10	20	25	30	40	50	75	100	125	150	175	200
12	MGQM	21	18	—	15	13	12	9	8	—	—	—	—
	MGQL	27	22	—	17	21	19	15	13	—	—	—	—
16	MGQM	34	28	—	25	22	19	15	13	—	—	—	—
	MGQL	38	30	—	26	37	33	28	23	—	—	—	—
20	MGQM	—	51	—	44	38	34	57	49	42	37	33	30
	MGQL	—	55	—	47	78	69	53	44	30	26	23	21
25	MGQM	—	70	—	60	53	47	77	65	56	49	44	40
	MGQL	—	71	—	61	77	72	59	51	42	36	32	29
32	MGQM	—	—	196	—	—	167	137	108	87	77	69	63
	MGQL	—	—	88	—	—	59	275	216	156	136	121	109
40	MGQM	—	—	196	—	—	167	137	108	87	77	69	63
	MGQL	—	—	88	—	—	59	275	216	156	136	121	109
50	MGQM	—	—	294	—	—	255	215	176	138	123	111	101
	MGQL	—	—	137	—	—	88	392	313	207	182	162	146
63	MGQM	—	—	294	—	—	255	215	176	138	123	111	101
	MGQL	—	—	137	—	—	88	392	313	207	182	162	146
80	MGQM	—	—	353	—	—	304	255	206	168	151	137	126
	MGQL	—	—	235	—	—	157	863	686	465	411	368	333
100	MGQM	—	—	539	—	—	470	412	343	278	252	230	211
	MGQL	—	—	470	—	—	313	1370	1070	708	627	562	509

Allowable Rotational Torque of Plate

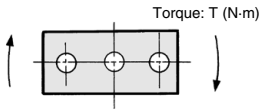

Bore size (mm)	Bearing type	Stroke (mm)											
		10	20	25	30	40	50	75	100	125	150	175	200
12	MGQM	0.29	0.24	—	0.21	0.18	0.16	0.13	0.10	—	—	—	—
	MGQL	0.48	0.39	—	0.31	0.37	0.33	0.27	0.23	—	—	—	—
16	MGQM	0.51	0.43	—	0.35	0.31	0.27	0.23	0.19	—	—	—	—
	MGQL	0.73	0.58	—	0.48	0.71	0.64	0.53	0.44	—	—	—	—
20	MGQM	—	0.91	—	0.78	0.71	0.63	1.04	0.88	0.77	0.68	0.60	0.55
	MGQL	—	1.26	—	1.06	1.77	1.58	1.22	1.01	0.69	0.60	0.53	0.48
25	MGQM	—	1.53	—	1.31	1.16	1.03	1.68	1.42	1.24	1.09	0.98	0.88
	MGQL	—	1.96	—	1.69	2.16	2.00	1.65	1.41	1.18	1.01	0.90	0.81
32	MGQM	—	—	3.92	—	—	2.94	2.45	3.46	1.72	1.53	1.37	1.24
	MGQL	—	—	1.96	—	—	0.98	5.88	4.41	3.12	2.72	2.42	2.18
40	MGQM	—	—	4.41	—	—	3.43	2.94	2.45	1.94	1.72	1.54	1.40
	MGQL	—	—	2.45	—	—	1.47	6.37	5.39	3.51	3.06	2.72	2.45
50	MGQM	—	—	7.35	—	—	5.88	4.90	4.41	3.43	3.06	2.77	2.52
	MGQL	—	—	3.43	—	—	2.20	10.78	8.33	5.18	4.55	4.05	3.65
63	MGQM	—	—	7.84	—	—	6.37	5.39	4.90	3.77	3.37	3.04	2.77
	MGQL	—	—	3.92	—	—	2.45	11.76	9.31	5.69	5.01	4.46	4.02
80	MGQM	—	—	11.76	—	—	9.80	7.84	6.86	5.88	5.28	4.79	4.39
	MGQL	—	—	9.31	—	—	5.88	31.36	24.50	16.28	14.39	12.88	11.66
100	MGQM	—	—	22.54	—	—	19.60	16.66	14.70	11.81	10.67	9.74	8.96
	MGQL	—	—	21.56	—	—	13.72	63.70	49.00	30.09	26.65	23.89	21.63

Non-rotating Accuracy of Plate

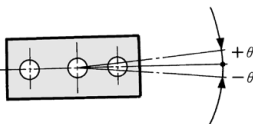

For non-rotating accuracy θ without load, use a value no more than the values in the table as a guide.

Bore size (mm)	Non-rotating accuracy θ	
	MGQM	MGQL
12		
16	$\pm 0.08^\circ$	$\pm 0.10^\circ$
20		
25	$\pm 0.07^\circ$	$\pm 0.09^\circ$
32		
40	$\pm 0.06^\circ$	$\pm 0.08^\circ$
50		
63	$\pm 0.05^\circ$	$\pm 0.06^\circ$
80		
100	$\pm 0.04^\circ$	$\pm 0.05^\circ$

- MGJ
- JMG P
- MG P
- MGP W
- MG Q
- MG G
- MG C
- MG F
- MG Z
- MG T

- D-□
- X□

Bore Size $\phi 12$ to $\phi 25$ /MGQM12 to 25 (Slide Bearing)

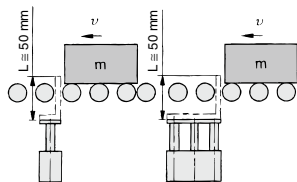

* When selecting a model with a longer L dimension, be sure to choose a bore size which is sufficiently large.

Caution on handling

Note 1) When using as a stopper, select a model with 30 stroke or less.

Note 2) Model MGQL (Ball bushing bearing) cannot be used as a stopper.

MGQM12 to 25 (Slide bearing)

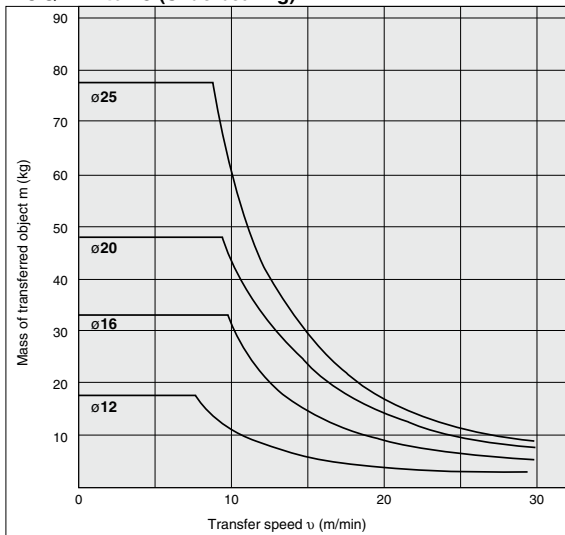

Bore Size $\phi 32$ to $\phi 100$ /MGQM32 to 100 (Slide Bearing)

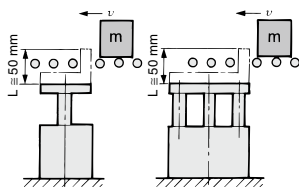

* When selecting a model with a longer L dimension, be sure to choose a bore size which is sufficiently large.

Caution on handling

Note 1) When using as a stopper, select a model with 50 stroke or less.

Note 2) Model MGQL (Ball bushing bearing) cannot be used as a stopper.

MGQM32 to 100 (Slide bearing)

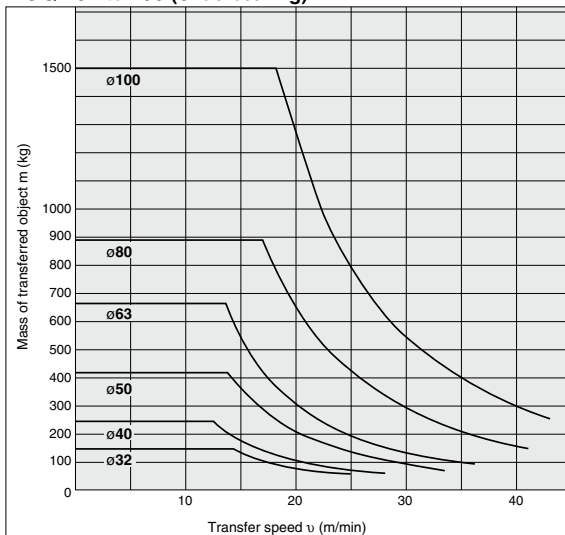

Operating Range when Used as Lifter

- Select the bore size so that the total load mass is below the theoretical output (see the table below).

Bore size (mm)	Theoretical output
12, 16	40% or below
20, 25	50% or below
32 to 100	60% or below

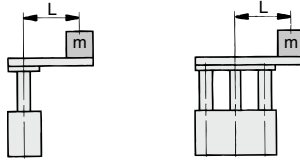

MGQM/Slide bearing

MGQM12 to 25-□

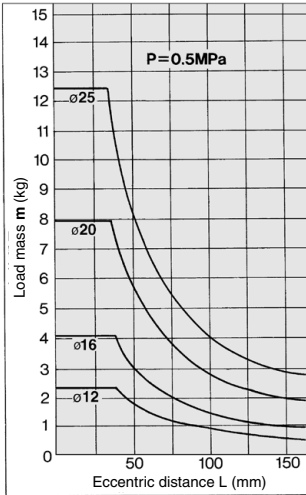

MGQL/Ball bushing bearing

MGQL12 to 25-¹⁰/₂₀-³⁰/₃₀ (10, 20, 30 Stroke)

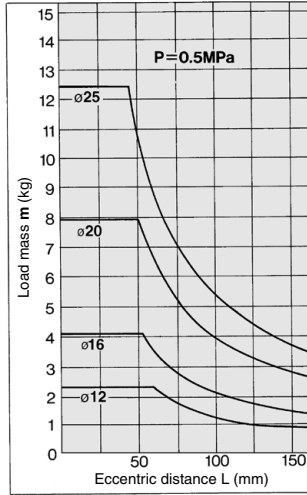

MGQL12 to 25-Over 30 stroke

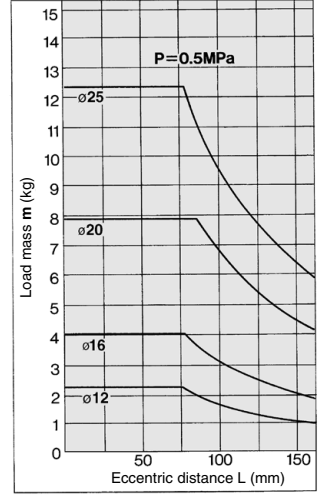

MGQM32 to 100 (Slide bearing)

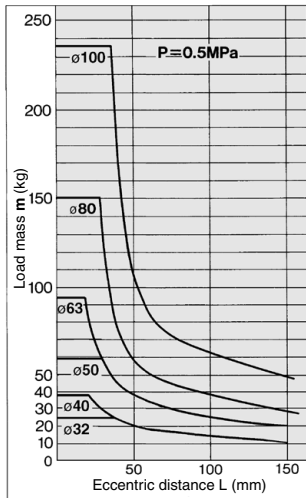

MGQL32 to 100-²⁵/₅₀ (25, 50 stroke)

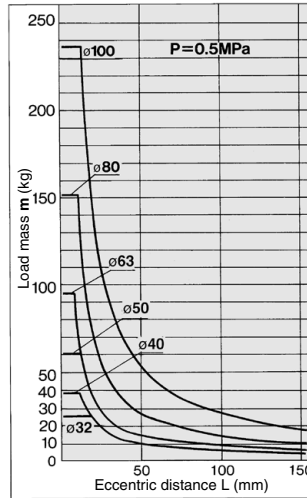

MGQL32 to 100-Over 50 stroke

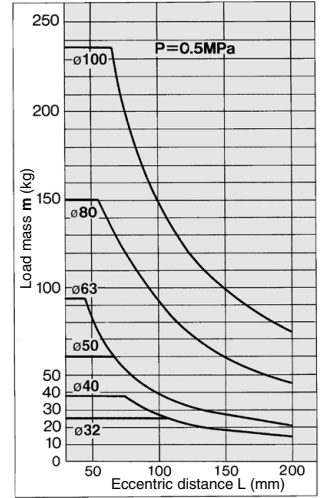

MGJ

JMGF

MGF

MGPW

MGQ

MGG

MGC

MGF

MGZ

MGT

D-□

-X□

MGQ Series

Construction/MGQM Series

MGQM12 to 25

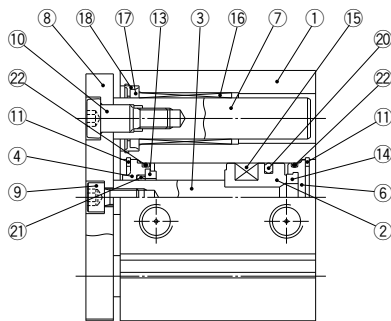

50 stroke or less

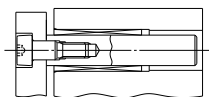

ø12, ø16

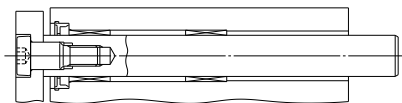

ø20, ø25 Over 50 stroke

MGQM32 to 100

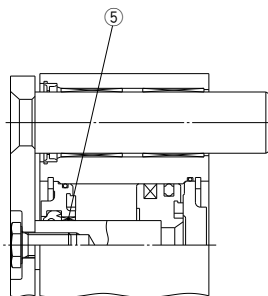
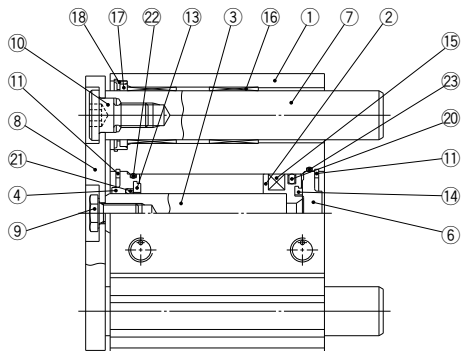

Over 50 stroke

Component Parts

No.	Description	Material	Note
1	Body	Aluminum alloy	Hard anodized
2	Piston	Aluminum alloy	
3	Piston rod	Stainless steel	ø12 to ø25
		Carbon steel	ø32 to ø100
4	Collar	Aluminum bearing alloy	ø12 to ø40
		Aluminum alloy casted	ø50 to ø100
5	Bushing	Bearing alloy	ø50 to ø100
6	Head cover	Aluminum alloy	ø12 to ø63
			ø80 to ø100
7	Guide rod	Carbon steel	Hard chrome plated
8	Plate	Carbon steel	Nickel plated
9	Plate mounting bolt	Carbon steel	Nickel plated
10	Guide bolt	Carbon steel	Nickel plated

No.	Description	Material	Note
11	Retaining ring	Carbon tool steel	Phosphate coated
12	Retaining ring	Carbon tool steel	Phosphate coated
13	Bumper A	Urethane	
14	Bumper B	Urethane	
15	Magnet	—	
16	Slide Bearing	Bearing alloy	
17	Felt	Felt	
18	Holder	Resin	
19	Ball bushing		
20*	Piston seal	NBR	
21*	Rod seal	NBR	
22*	Gasket A	NBR	
23*	Gasket B	NBR	

Replacement Parts: Seal Kit

Bore size (mm)	Kit no.	Description
12	MGQ12-PS	A set of ⑳, ㉑, ㉒ and ㉓ listed above
16	MGQ16-PS	
20	MGQ20-PS	
25	MGQ25-PS	
32	MGQ32-PS	

* Seal kit includes ㉒ to ㉓. Order the seal kit, based on each bore size.

Bore size (mm)	Kit no.	Description
40	MGQ40-PS	A set of ㉒, ㉑, ㉓ and ㉔ listed above
50	MGQ50-PS	
63	MGQ63-PS	
80	MGQ80-PS	
100	MGQ100-PS	

* Since the seal kit does not include a grease pack, order it separately.
Grease pack part no.: GR-S-010 (10 g)

Construction/MGQL Series

MGQL12 to 25

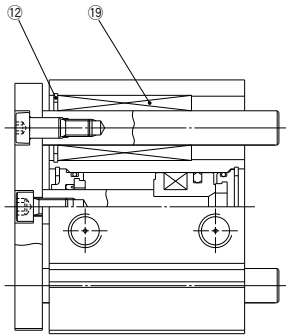

30 stroke or less

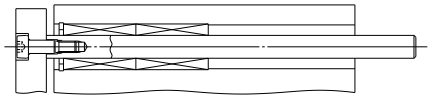

ø12, ø16 Over 30 stroke

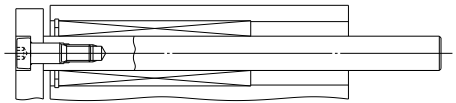

ø20, ø25 Over 30 stroke

MGQL32 to 100

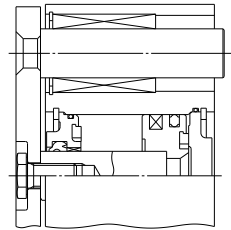
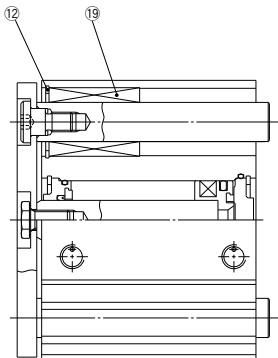

ø50 or more

- MGJ
- JMGP
- MGP
- MGPW
- MGQ**
- MGG
- MGC
- MGF
- MGZ
- MGT

- D-□
- X□

MGQ Series

Bore Size $\varnothing 12$ to $\varnothing 25$: MGQM, MGQL

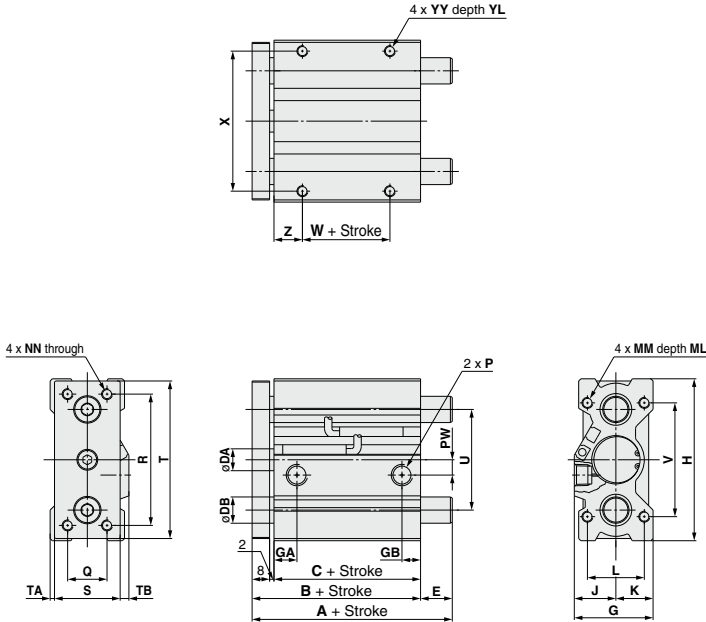

MGQM, MGQL Common Dimensions

Bore size (mm)	Standard stroke (mm)	B	C	DA	G	GA	GB	H	J	K	L	MM	ML	NN	P			PW	Q	R
															Nil	TN	TF			
12	10, 20, 30, 40, 50, 75, 100	39	29	6	29	11	7.5	58	16	13	18	M4 x 0.7	10	M4 x 0.7	M5 x 0.8	—	—	7	14	48
16	20, 30, 40, 50, 75, 100	43	33	8	33	11	8	64	18	15	22	M5 x 0.8	13	M5 x 0.8	M5 x 0.8	—	—	5	16	52
20	125, 150, 175, 200	47	37	10	36	10.5	8.5	74	19	17	26	M5 x 0.8	13	M5 x 0.8	Rc1/8	NPT1/8	G1/8	7	18	60
25		47.5	37.5	12	42	11.5	9	88	21	21	32	M6 x 1.0	15	M6 x 1.0	Rc1/8	NPT1/8	G1/8	8	26	70

Bore size (mm)	S	T	TA	TB	U	V	W	X	YY	YL	Z
12	22	56	2	5	36	40	5	50	M4 x 0.7	7	12
16	25	62	2.5	5.5	38	42	7	54	M5 x 0.8	8	13
20	30	72	2	4	46	52	10	64	M5 x 0.8	8	13
25	38	86	2	2	56	62	10	76	M6 x 1.0	9	14

MGQM (Slide bearing)/A, DB, E Dimensions (mm)

Bore size (mm)	A		DB	E	
	50 st or less	Over 50 st		50 st or less	Over 50 st
12	39		8	0	
16	43		10	0	
20	47	61.5	12	0	14.5
25	47.5	62	16	0	14.5

MGQL (Ball bushing bearing)/A, DB, E Dimensions (mm)

Bore size (mm)	A		DB	E	
	30 st or less	Over 30 st		30 st or less	Over 30 st
12	43	55	6	4	16
16	49	65	8	6	22
20	57	74	10	10	27
25	63.5	79.5	13	16	32

Note) For intermediate strokes other than standard strokes, refer to the Manufacture of Intermediate Stroke on page 521.

• Bore size 12 and 16 are only for the M5 x 0.8 port.

• For bore size 20 or more, Rc, NPT and G ports can be selected. (Refer to page 520.)

Bore Size $\phi 32$ to $\phi 100$: MGQM, MGQL

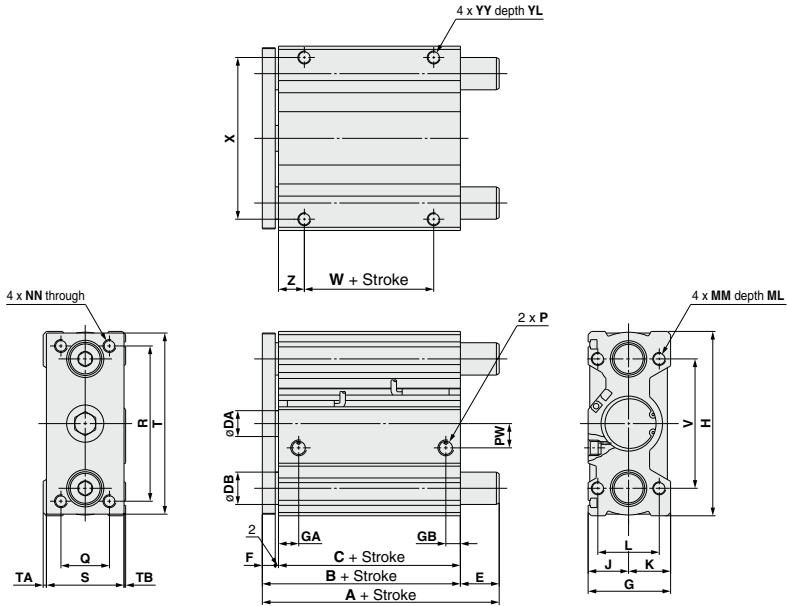

MGQM, MGQL Common Dimensions

Bore size (mm)	Standard stroke (mm)	B	C	DA	F	G	GA	GB	H	J	K	L	MM	ML	NN	P			PW	Q	R	S
																Nil	TN	TF				
32	25, 50, 75, 100, 125, 150, 175, 200	47.5	37.5	16	8	51	12.5	9	114	25	26	38	M8 x 1.25	20	M8 x 1.25	Rc1/8	NPT1/8	G1/8	15	30	96	48
40		54	44	16	8	51	14	10	124	25	26	38	M8 x 1.25	20	M8 x 1.25	Rc1/8	NPT1/8	G1/8	21	30	106	48
50		56	44	20	10	59	14	11	140	29	30	44	M10 x 1.5	25	M10 x 1.5	Rc1/4	NPT1/4	G1/4	27	40	120	56
63		61	49	20	10	72	16.5	13.5	150	35.5	36.5	44	M10 x 1.5	25	M10 x 1.5	Rc1/4	NPT1/4	G1/4	33	50	130	69
80		74.5	56.5	25	16	92	19	15.5	188	45.5	46.5	56	M12 x 1.75	30	M12 x 1.75	Rc3/8	NPT3/8	G3/8	37	60	160	88
100	84	66	30	16	112	23	19	224	55.5	56.5	62	M14 x 2	35	M14 x 2	Rc3/8	NPT3/8	G3/8	40	80	190	108	

Bore size (mm)	T	TA	TB	V	W	X	YY	YL	Z
32	112	2	1	80	5	100	M8 x 1.25	11	16
40	122	2	1	90	10	110	M8 x 1.25	11	17
50	138	2	1	100	10	124	M10 x 1.5	12.5	17
63	148	2	1	110	10	132	M10 x 1.5	15	19
80	185	2.5	1.5	140	15	166	M12 x 1.75	18	21
100	221	2.5	1.5	170	15	200	M14 x 2	21	25

MGQM (Slide bearing)/ A, DB, E Dimensions

Bore size (mm)	A, DB, E Dimensions		
	A	DB	E
32	71.5	20	24
40	71.5	20	17.5
50	81	25	25
63	81	25	20
80	93	28	18.5
100	105	36	21

MGQL (Ball bushing bearing)/ A, DB, E Dimensions

Bore size (mm)	A, DB, E Dimensions					
	A		DB	E		S
	50 st or less	Over 50 st		50 st or less	Over 50 st	
32	53	90	16	5.5	42.5	
40	54	90	16	0	36	
50	60	102	20	4	46	
63	61	102	20	0	41	
80	84	143	25	9.5	68.5	
100	89	153	30	5	69	

(Note) For intermediate strokes other than standard strokes, refer to the Manufacture of Intermediate Stroke on page 521.

• Rc, NPT and G ports can be selected. (Refer to page 520.)

Grooves (Except $\phi 12$, $\phi 16$, $\phi 20$, $\phi 25$)

Use groove section "a" and section "b" in the figure below of the cylinder body for firmly fixing in the following case. (Applicable bolt size is M3.)

- These grooves can be used for firmly fixing the tying bands of lead wires of the auto switch, etc., and also terminal boards, etc., to the main body of the cylinder.
- When the terminal block is fixed on a cylinder directly.

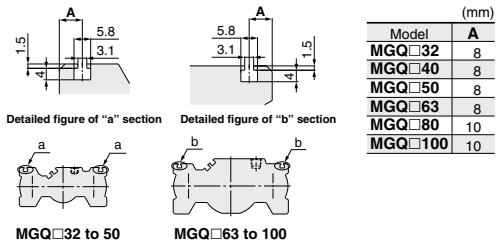

Auto Switch Mounting

Minimum Stroke for Auto Switch

Auto switch model	No. of auto switches mounted	ø12	ø16	ø20	ø25	ø32	ø40	ø50	ø63	ø80	ø100
D-A9□	1 pc.	5 (Note 1)					5				
	2 pcs.	10 (Note 1)					10				
D-A9□V D-M9□V	1 pc.					5					
	2 pcs.					10					
D-M9□	1 pc.	5 (Note 1)					5				
	2 pcs.	10 (Note 1)				10					
D-M9□W	1 pc.					5 (Note 2)					
	2 pcs.	10 (Note 2)				10					
D-M9□WV D-M9□AV	1 pc.					5 (Note 2)					
	2 pcs.					10					
D-M9□A	1 pc.					5 (Note 2)					
	2 pcs.					10 (Note 2)					
D-Z7□ D-Z80 D-Y59□ D-Y7P	1 pc.	5 (Note 1)					5				
	2 pcs.	10 (Note 1)				10					
D-Y69□ D-Y7PV	1 pc.					5					
	2 pcs.					5					
D-Y7□W D-Y7□WV D-Y7BA	1 pc.					5 (Note 2)					
	2 pcs.					10 (Note 2)					

Note 1) Confirm that it is possible to secure the bending radius of 10 mm of the auto switch lead wire before use.
 Note 2) Confirm that it is possible to securely set the auto switch(es) within the range of indicator green light ON range before use.
 For in-line entry type, please also consider Note 1) shown above.

Auto Switch Proper Mounting Position (Detection at Stroke End)

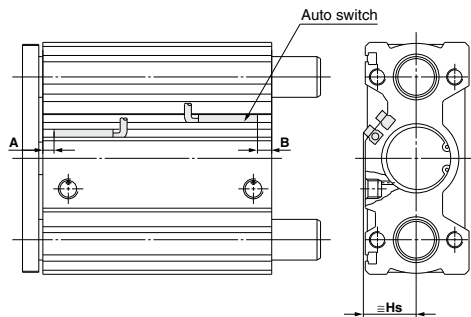

Auto Switch Proper Mounting Position

Auto switch model	Auto switch proper mounting position (mm)					
	D-M9□ D-M9□V D-M9□W D-M9□WV D-M9□A D-M9□AV		D-A9□ D-A9□V		D-Z7□/Z80 D-Y59□/Y7P D-Y69□/Y7PV D-Y7□W D-Y7□WV D-Y7BA	
	A	B	A	B	A	B
12	6	8	2	4	1	3
16	9	9	5	5	4	4
20	9.5	12.5	5.5	8.5	4.5	7.5
25	9.5	13	5.5	9	4.5	8
32	10.5	12	6.5	8	5.5	7
40	14.5	14.5	10.5	10.5	9.5	9.5
50	12.5	16.5	8.5	12.5	7.5	11.5
63	15	19	11	15	10	14
80	18	23.5	14	19.5	13	18.5
100	22.5	28.5	18.5	24.5	17.5	23.5

(Note) Adjust the auto switch after confirming the operating conditions in the actual setting.

Auto Switch Mounting Height

Auto switch model	Auto switch mounting height (mm)			
	D-A9□V		D-M9□V D-M9□WV D-M9□AV	D-Y69□ D-Y7PV D-Y7□WV
	Hs	Hs	Hs	Hs
12	16	18.5	20.5	17
16	18.5	21	23	19.5
20	19.5	22.5	24.5	20.5
25	21	23.5	26	22
32	24.5	27	28.5	25.5
40	24	26	27.5	25
50	28	30	31.5	29
63	34.5	36.5	39.5	35.5
80	44	46.5	48.5	45
100	52	54	56	52.5

Operating Range

Auto switch model	Bore size (mm)									
	12	16	20	25	32	40	50	63	80	100
D-A9□/A9□V	7	9.5	9	9	9	9	9	10.5	10	10.5
D-M9□/M9□V D-M9□W/M9□WV	4	5.5	5	5	5.5	5	5.5	5.5	6.5	7
D-Z7□/Z80	5	6	6	6.5	8.5	8.5	9	10	10	11.5
D-Y5□□/Y6□□/Y7□□										

Since the operating range is provided as a guideline including hysteresis, it cannot be guaranteed (assuming approximately ±30% dispersion). It may vary substantially depending on an ambient environment.

Auto Switch Mounting Bracket: Part No.

Auto switch model	Bore size (mm)
	ø12 to ø100
D-A9□/A9□V D-M9□/M9□V D-M9□W/M9□WV	BMG2-012

D-A9□(V)/M9□(V)/M9□W(V)

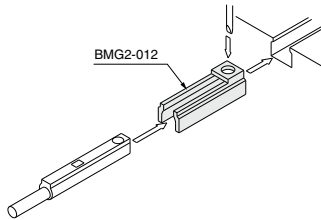

Other than the applicable auto switches listed in "How to Order", the following auto switches can be mounted. For detailed specifications, refer to pages 1119 to 1245.

Auto switch type	Model	Electrical entry (Fetching direction)	Features
Reed	D-Z73, Z76	Grommet (In-line)	—
	D-Z80		Without indicator light
Solid state	D-Y69A, Y69B, Y7PV	Grommet (Perpendicular)	—
	D-Y7NWV, Y7PWV, Y7BWV		Diagnostic indication (2-color indicator)
	D-Y59A, Y59B, Y7P	Grommet (In-line)	—
	D-Y7NW, Y7PW, Y7BW		Diagnostic indication (2-color indicator)
	D-Y7BA		Water resistant (2-color indicator)

* For solid state auto switches, auto switches with a pre-wired connector are also available. Refer to pages 1192 and 1193 for details.

* Normally closed (NC = b contact), solid state auto switch (D-F9G/F9H/Y7G/Y7H type) are also available. For details, refer to pages 1137 and 1139.

- MGJ
- JMGP
- MGP
- MGPW
- MGQ**
- MGG
- MGC
- MGF
- MGZ
- MGT

- D-□
- X□



1 Helical Insert Thread Specifications

Symbol
-X168

MGQ^M [Bore size] - [Stroke] - [Auto switch type] [Lead wire length] [No. of auto switches] -X168

Helical insert thread specifications

Mounting thread type has been changed to the helical insert thread type.

Specifications

Bearing type	Slide bearing	Ball bushing bearing
Series	MGQM	MGQL
Bore size (mm)	32, 40, 50, 63, 80, 100	
Lubrication	Non-lube	
Auto switch	Mountable	

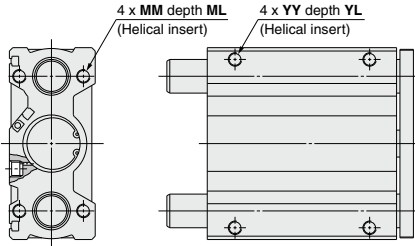

Bore size (mm)	MM	ML	YY	YL
32	M6 x 1.0	12	M6 x 1.0	9
40	M6 x 1.0	12	M6 x 1.0	9
50	M8 x 1.25	16	M8 x 1.25	12
63	M8 x 1.25	16	M8 x 1.25	12
80	M10 x 1.5	20	M10 x 1.5	15
100	M12 x 1.75	24	M12 x 1.75	18

Note) Other dimensions are the same as standard type.

2 Bottom Mounting Type (MGQM type is only available.)

Symbol
-X367

MGQ M 32 - 50 - -X367

Compact guide cylinder

Bearing type
M Slide bearing

Bore size (mm)

20	20 mm
25	25 mm
32	32 mm
40	40 mm
50	50 mm
63	63 mm
80	80 mm
100	100 mm

Port thread type

Auto switch

Cylinder stroke (mm)

Bore size (mm)	Applicable stroke (mm)
20 to 25	75, 100
32 to 100	25, 50, 75, 100

Suffix for auto switch

Bottom mounting type

Because the guide rods do not protrude from the bottom surface of the body, it is not necessary to machine relief holes for the guide rods.

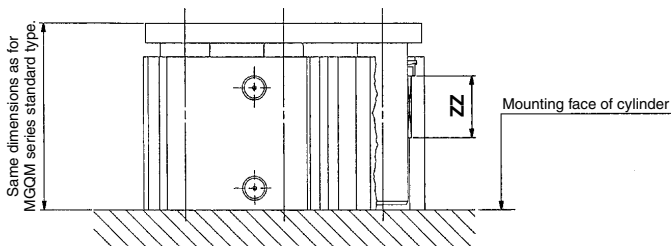

Note) Full length dimension of bushing for guide rod (ZZ) is shorter than the standard type.

3 Long Bushing Type (MGQL type is only available.)

Symbol

-X399

MGQL Bore size — Stroke — Auto switch type Lead wire length No. of auto switches — X399

ø32 to ø100/MGQL-X399: Long bushing type

Long bushing type

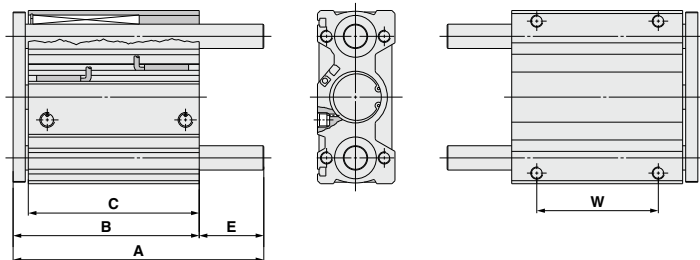

(mm)

Bore (mm)	Applicable stroke	A	B	C	E	W
32	5, 10, 15, 20, 25, 30, 40, 50	165	122.5	112.5	42.5	80
40		165	129	119	36	85
50		177	131	119	46	85
63		177	136	124	41	85
80		218	149.5	131.5	68.5	90
100		228	159	141	69	90

Note 1) Dimensions are the same as for standard type of 75 stroke.

Note 2) Applicable stroke is available at 5 mm intervals and the spacer is installed inside.

Note 3) Ball bushing bearing type with 50 stroke or less is twice as long as the normal bearing length to strengthen the guide.

4 Magnetic Field Resistant Auto Switch (D-P4DW)

Symbol

-X563

MGQ_L^M Bore size — Stroke — P4DW Lead wire length No. of auto switches — X563

Magnetic field resistant auto switch (D-P4DW)

Specifications

Bearing type	Slide bearing	Ball bushing bearing
Series	MGQM	MGQL
Bore size (mm)	40, 50, 63, 80, 100	
Lubrication	Non-lube	
Auto switch	Mountable	

Note) For 25, 50 stroke, the number of available auto switch is 1 pc.

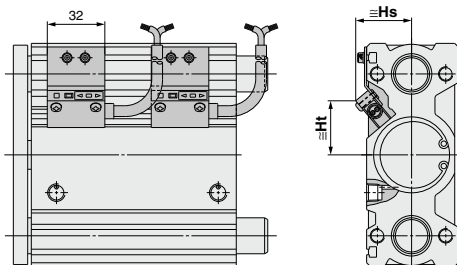

(mm)

Bore size (mm)	Hs	Ht
40	31.5	30.1
50	35.0	34.7
63	42.5	36.1
80	53.5	38.7
100	60.5	45.1

MGJ

JMP

MGP

MGPW

MGQ

MGG

MGC

MGF

MGZ

MGT

D-□

-X□



MGQ Series Specific Product Precautions

Be sure to read this before handling the products. Refer to back page 50 for Safety Instructions and pages 3 to 12 for Actuator and Auto Switch Precautions.

Mounting

Warning

1. Avoid placing your hands or fingers between the plate and the body.

- Be very careful to prevent your hands or fingers from getting caught in the gap between the cylinder body and the plate when air is applied.

Caution

1. Do not scratch or gouge the sliding portion of the piston rod and the guide rod.
- Damaged seals, etc. will result in leakage or malfunction.
2. Do not dent or scratch the mounting surface of a body and a plate.
- The flatness of the mounting surface may not be maintained, which would cause the sliding resistance to increase.
3. Make sure that the cylinder mounting surface has a flatness of 0.05 mm or less.
- If the flatness of the workpieces and brackets mounted on the plate is not appropriate, sliding resistance may increase.
4. When mounting on the bottom of the cylinder, the guide rod protrudes from the bottom at the retraction stroke end. Therefore, drill holes for the hexagon socket bolts used for mounting purposes, and relief holes for the guide rods. Moreover, in applications where impact occurs from a stopper, etc., the mounting bolts should be inserted to a depth of 2 d or more.

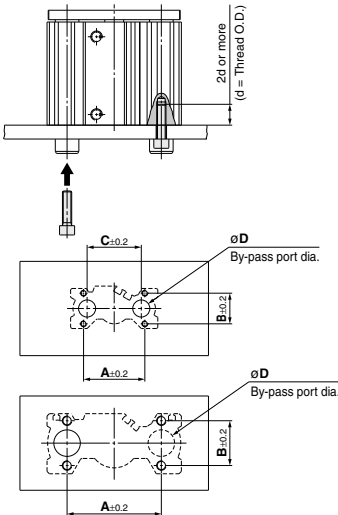

Bore size (mm)	A (mm)	B (mm)	C (mm)	øD (mm)		Hexagon socket head cap screw
				MGQM	MGQL	
12	40	18	36	10	8	M4 x 0.7
16	42	22	38	12	10	M5 x 0.8
20	52	26	46	14	12	M5 x 0.8
25	62	32	56	18	15	M6 x 1
32	80	38	—	22	18	M8 x 1.25
40	90	38	—	22	18	M8 x 1.25
50	100	44	—	27	22	M10 x 1.5
63	110	44	—	27	22	M10 x 1.5
80	140	56	—	31	28	M12 x 1.75
100	170	62	—	39	33	M14 x 2

C dimension for a bore size of 32 to 100 is identical to the A dimension.

Allowable Kinetic Energy

Load mass and cylinder speed should be observed within the range given in the graph below.

MGQ with a rubber bumper

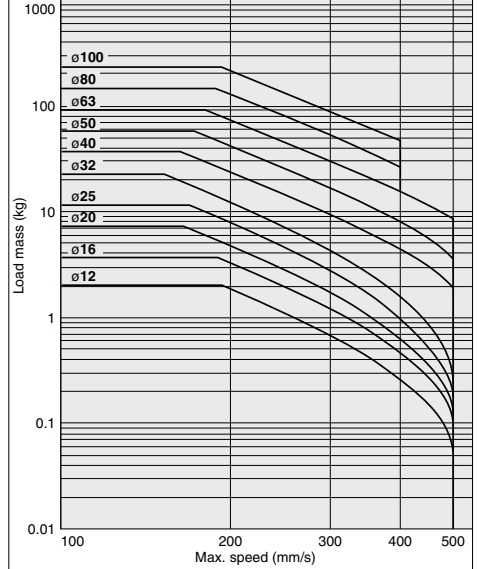

MGQ without a cushion (XB6, XC22)

