

Directional spool valves, direct operated,  
smoothly switching, with solenoid actuation

Type WE . .73...A12

**RE 23183**

Edition: 2013-06

Replaces: 04.05



- ▶ Size 6
- ▶ Component series 6X
- ▶ Maximum operating pressure 350 bar [5076 psi]
- ▶ Maximum flow 60 l/min [15.9 US gpm]
- ▶ Smooth switching behavior

## Features

- ▶ 4/2 or 4/3 directional design
- ▶ Porting pattern according to DIN 24340 form A
- ▶ Porting pattern according to ISO 4401-03-02-0-05 and NFPA T3.5.1 R2-2002 D03 (**with** locating hole)
- ▶ Wet-pin DC solenoids with detachable coil
- ▶ Solenoid coil can be rotated by 90°
- ▶ The coil can be changed without having to open the pressure-tight chamber
- ▶ Electrical connection as individual or central connection
- ▶ With concealed manual override

## Contents

Features	1
Ordering code	2, 3
Symbols	4
Function, section	5
Technical data	6, 7
Acceleration value	7
Characteristic curves	8
Performance limits	8
Dimensions	9 ... 11
Mating connectors	12
More information	12

## Ordering code

01	02	03	04	05	06	07	08	09	10	11	12	13	14	15	16
	<b>WE</b>	<b>6</b>		<b>-</b>	<b>6X</b>	<b>/</b>		<b>E</b>		<b>N9</b>	<b>/</b>	<b>A12</b>			<b>*</b>

01	3 main ports	<b>3</b>
	4 main ports	<b>4</b>
02	Directional valve	<b>WE</b>
03	Size 6	<b>6</b>
04	Symbols e.g. D73, E73, E73A, E73B etc; for possible design, see page 4	
05	Component series 60 ... 69 (60 ... 69: Unchanged installation and connection dimensions)	<b>6X</b>
06	<b>With</b> spring return	<b>no code</b>
	<b>Without</b> spring return with detent (only with symbol "D73")	<b>OF</b>
07	High-power wet-pin solenoid with detachable coil	<b>E</b>
08	Direct voltage 24 V	<b>G24</b>
	Direct voltage 205 V	<b>G205<sup>1)</sup></b>
	Possible voltages see page 7	
09	<b>With</b> concealed manual override	<b>N9</b>

### Electrical connection <sup>2)</sup>

10	<b>Individual connection</b>	
	<b>Without</b> mating connector; connector DIN EN 175301-803	<b>K4<sup>3)</sup></b>
	<b>Central connection</b>	
	Cable entry at the cover, with indicator light	<b>DL</b>
	Central plug-in connection at the cover, with indicator light (without mating connector); connector according to DIN EN 175201-804	<b>DK6L</b>
	For further electrical connections, see data sheet 08010	
11	Influencing the switching time	<b>A12</b>
12	<b>Without</b> throttle insert	<b>no code</b>
	Throttle insert Ø 0.8 mm [0.031 inch]	<b>B08</b>
	Throttle insert Ø 1.0 mm [0.039 inch]	<b>B10</b>
	Throttle insert Ø 1.2 mm [0.047 inch]	<b>B12</b>
	Use if flow higher than performance limit of the valve, effective in channel P	

### Clamping length

13	42 mm [1.65 inch] (standard)	<b>no code</b>
	22 mm [0.87 inch]	<b>Z</b>

### Seal material

14	NBR seals	<b>no code</b>
	FKM seals	<b>V</b>
	Attention: Observe compatibility of seals with hydraulic fluid used! (Other seals upon request)	
15	<b>Without</b> locating hole	<b>no code</b>
	<b>With</b> locating hole	<b>/60<sup>4)</sup></b>
16	Further details in the plain text	

Footnotes see page 3.

## Ordering code

- 1) For connection to the AC voltage mains, a DC solenoid **must** be used, which is controlled via a rectifier (see table below). In case of individual connections, a mating connector with integrated rectifier can be used (separate order, see page 12).
- 2) Also available with M12x1 plug-in connection (only design "G24"), see data sheet 08010.
- 3) Mating connectors, separate order, see page 12 and data sheet 08006.
- 4) Locking pin ISO 8752-3x8-St, material no. **R900005694** (separate order).

AC voltage mains (admissible voltage tolerance $\pm 10\%$ )	Nominal voltage of the DC solenoid in case of operation with alternating voltage	Ordering code
110 V – 50/60 Hz 120 V – 60 Hz	96 V	<b>G96</b>
230 V – 50/60 Hz	205 V	<b>G205</b>

Symbols

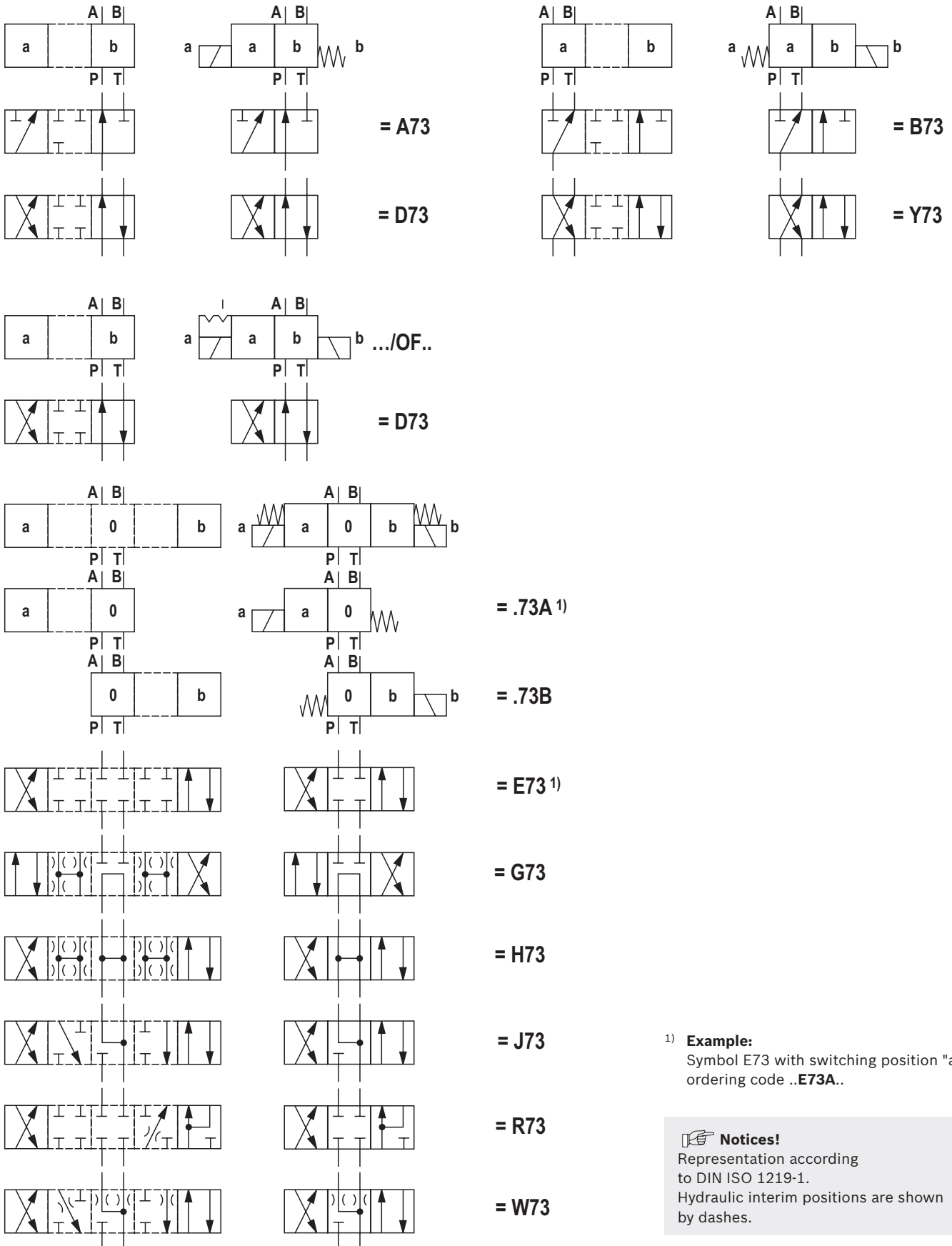

1) **Example:**  
Symbol E73 with switching position "a"  
ordering code **..E73A..**

**Notices!**  
Representation according to DIN ISO 1219-1.  
Hydraulic interim positions are shown by dashes.

## Function, section

Directional valves type WE . .73... are solenoid-actuated directional spool valves with smooth switching behavior. They control start, stop and direction of the flow. By means of structural design of the control spools and solenoids, switching shocks occurring when activating and deactivating the valves are significantly reduced. The switching shocks, measured as acceleration values **a**, can be reduced by up to approx. 85 % when compared to the standard valve depending on the design of the control spool (for this, see "Acceleration values" on page 7). The directional valves basically consist of the housing (1), one or two solenoids (2), the control spool (3), and one or two return springs (4). In the de-energized condition, the control spool (3) is held in the central position or in the initial position by the return springs (4) (except for impulse spools). The control spool (3) is actuated by wet-pin solenoids (2).

**To ensure proper functioning, make sure that the pressure chamber of the solenoid is filled with oil.**

The force of the solenoid (2) acts via the plunger (5) on the control spool (3) and pushes the latter from its rest position to the required end position. This enables the required direction of flow from P to A and B to T or P to B and A to T.

After the solenoid (2) is de-energized, the return spring (4) pushes the control spool (3) back to its rest position. A manual override (6) allows the control spool (3) to be moved without solenoid energization.

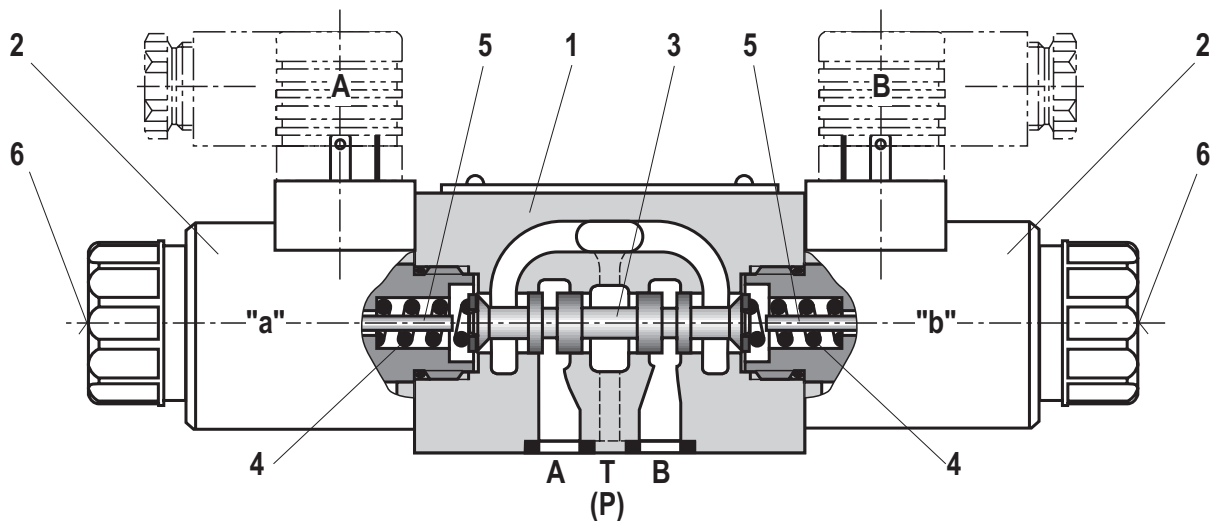

Type 4WE 6 E73-6X/E.../A12...

### Throttle insert

The use of a throttle insert is required when, due to prevailing operating conditions, flows can occur during the switching processes, which exceed the performance limit of the valve.

It is inserted in channel P of the directional valve.

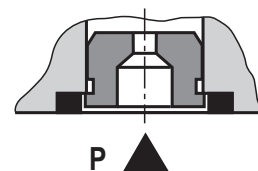

Type 4WE...73.../.../B..

**Technical data**

(for applications outside these parameters, please consult us!)

<b>general</b>			
Weight	- Valve with one solenoid	kg [lbs]	1.45 [3.2]
	- Valve with two solenoids	kg [lbs]	1.95 [4.3]
Installation position			Any <sup>1)</sup>
Ambient temperature range		°C [°F]	-30 ... +50 [-22... +122] (NBR seals) -20 ... +50 [-4... +122] (FKM seals)
Acceleration <b>a</b>		%	See "Acceleration values" page 7
MTTF <sub>d</sub> values according to EN ISO 13849		Years	150 (for further details, see data sheet 08012)

<b>hydraulic</b>			
Maximum operating pressure	- Port A, B, P	bar [psi]	350 [5076]
	- Port T	bar [psi]	210 [3046]
Maximum flow		l/min [US gpm]	60 [15.9]
Hydraulic fluid			See table below
Hydraulic fluid temperature range		°C [°F]	-30 ... +80 [-22... +176] (NBR seals) -15 ... +80 [-4... +176] (FKM seals)
Viscosity range		mm <sup>2</sup> /s [SUS]	2.8 ... 500 [13... 2317]
Maximum admissible degree of contamination of the hydraulic fluid - cleanliness class according to ISO 4406 (c)			Class 20/18/15 <sup>2)</sup>

Hydraulic fluid	Classification	Suitable sealing materials	Standards
Mineral oils	HL, HLP, HLPD, HVLP, HVLPD	NBR, FKM	DIN 51524
Bio-degradable	- insoluble in water	HETG	VDMA 24568
		HEES	
	- soluble in water	HEPG	VDMA 24568
	- water-free	HFDU, HFDR	ISO 12922
Flame-resistant	- containing water	HFC (Fuchs Hydrotherm 46M, Petrofer Ultra Safe 620)	ISO 12922

**Important information on hydraulic fluids!**

- ▶ For more information and data on the use of other hydraulic fluids, refer to data sheet 90220 or contact us.
- ▶ There may be limitations regarding the technical valve data (temperature, pressure range, life cycle, maintenance intervals, etc.)!
- ▶ The flash point of the hydraulic fluid used must be 40 K higher than the maximum solenoid surface temperature.

**▶ Flame-resistant – containing water:**

- Maximum pressure difference per control edge 50 bar
- Pressure pre-loading at the tank port > 20 % of the pressure differential, otherwise increased cavitation
- Life cycle as compared to operation with mineral oil HL, HLP 50 to 100 %

- ▶ **Bio-degradable:** When using bio-degradable hydraulic fluids that are simultaneously zinc-solvent, zinc may accumulate in the fluid (per pole tube 700 mg zinc).

<sup>1)</sup> With suspended installation, higher sensitivity to contamination. Horizontal installation is recommended.

<sup>2)</sup> The cleanliness classes specified for the components must be adhered to in hydraulic systems. Effective filtration prevents faults and at the same time increases the life cycle of the components.  
For the selection of the filters see [www.boschrexroth.com/filter](http://www.boschrexroth.com/filter).

## Technical data

(for applications outside these parameters, please consult us!)

electric		
Available voltages <sup>2)</sup>	V	12, 24, 96, 205
Voltage tolerance (nominal voltage)	%	±10
Power consumption	W	30
Duty cycle	%	100
Switching time according to ISO 6403	ms	Approx. 3 to 4 times longer than standard valve
Maximum switching frequency	1/h	7200
Maximum surface temperature of the coil <sup>3)</sup>	°C [°F]	150 [302]
Protection class according to DIN EN 60529		IP 65 (with mating connector mounted and locked)
Insulation class VDE 0580		F
Electrical protection		Every solenoid must be protected individually, using a suitable fuse with tripping characteristic K (inductive loads).
Behavior in case of errors		The specified solenoid surface temperature may be exceeded.

<sup>2)</sup> Special voltages on request

<sup>3)</sup> Possible surface temperature > 50 °C, provide contact protection!

**When establishing the electrical connection, the protective earthing conductor (PE  $\perp$ ) must be connected correctly.**

### Notices!

- ▶ The solenoid coils must not be painted.
- ▶ Operation of the manual override is only possible up to a tank pressure of approx. 50 bar [725 psi]. Avoid damage to the bore of the manual override! (Special tool for the operation, separate order, material no. **R900024943**). When the manual override is blocked, operation of the opposite solenoid must be disabled!
- ▶ The simultaneous operation of 2 solenoids of one valve must be disabled!
- ▶ Use cables that are approved for an operation temperature above 105 °C [221 °F].

- ▶ Valves with individual connection and supply voltage 12 V or 24 V can be operated with twice the voltage for reducing the switching time. For this purpose, the voltage has to be reduced to the nominal valve voltage after 100 ms by means of pulse width modulation. The maximum admissible switching frequency is 3 1/s.
- ▶ Due to possible overloads of the printed-circuit board, valves with central connection must not be operated with twice the voltage.
- ▶ If the standard ambient conditions in accordance with VDE 0580 cannot be complied with, the valve must be protected separately!

## Acceleration value $a$ (measured at the cylinder)

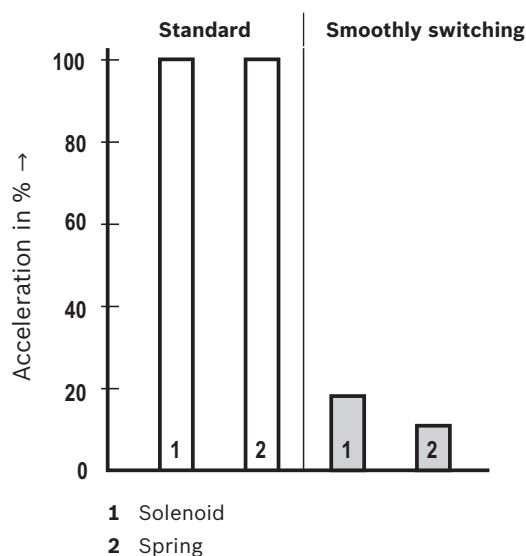

### Notice!

Damping significantly reduces switching shocks so that the acceleration values and acceleration noise (judder) at the actuator are reduced to approx. 20%. Within the pole tube, the switching off time is increased proportionally to the flow by 20 ... 30%, the run up time is increased by up to 20%.

### Characteristic curves

(measured with HLP46,  $\vartheta_{oil} = 40 \pm 5 \text{ }^\circ\text{C}$  [104 ± 9 °F])

$\Delta p$ - $q_v$  characteristic curves

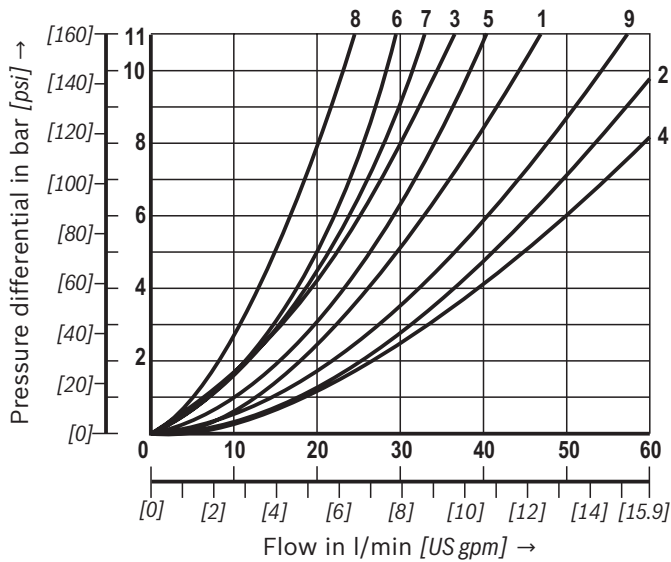

Symbol	Direction of flow					
	P - A	P - B	A - T	B - T	P - T	B - A
E73	1	1	1	1	-	-
J73	3	3	2	2	-	-
H73	1	1	1	1	5	-
A/B73	6	6	-	-	-	-
D/Y73	7	7	7	7	-	-
G73	8	8	8	8	5	
R73	9	6	9	-	-	6
W73	9	9	9	9	-	-

- 5 Symbol "R73" in switching position B - A (differential circuit)
- 6 Symbol "R73" in switching position P - B (differential circuit)

### Performance limits

(measured with HLP46,  $\vartheta_{oil} = 40 \pm 5 \text{ }^\circ\text{C}$  [104 ± 9 °F])

**Notice!**

The specified switching power limits are valid for operation with two directions of flow (e.g. from P to A and simultaneous return flow from B to T).

Due to the flow forces acting within the valves, the permissible switching power limit may be considerably lower with only one direction of flow (e.g. from P to A

while port B is blocked) the admissible switching power limit must be significantly lower!

In such cases of application, please consult us!

**The switching power limit was established while the solenoids were at operating temperature, at 10 % undervoltage, and without tank preloading.**

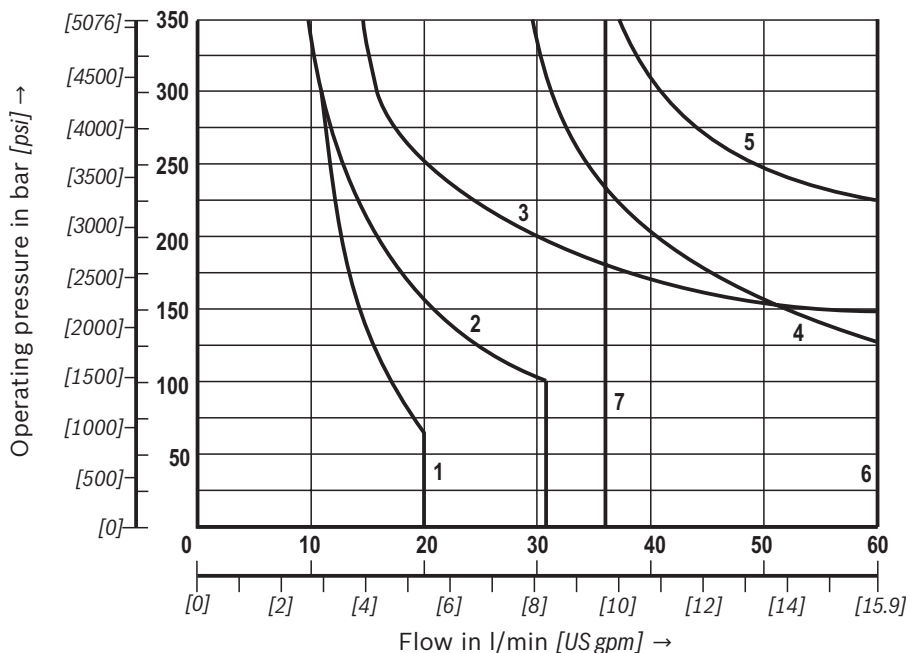

Characteristic curve	Symbol
1	A73, B73
2	G73
3	D73, Y73
4	J73
5	R73
6	E73, W73, D73/OF
7	H73



**Dimensions:** Individual connection  
(dimensions in mm [inch])

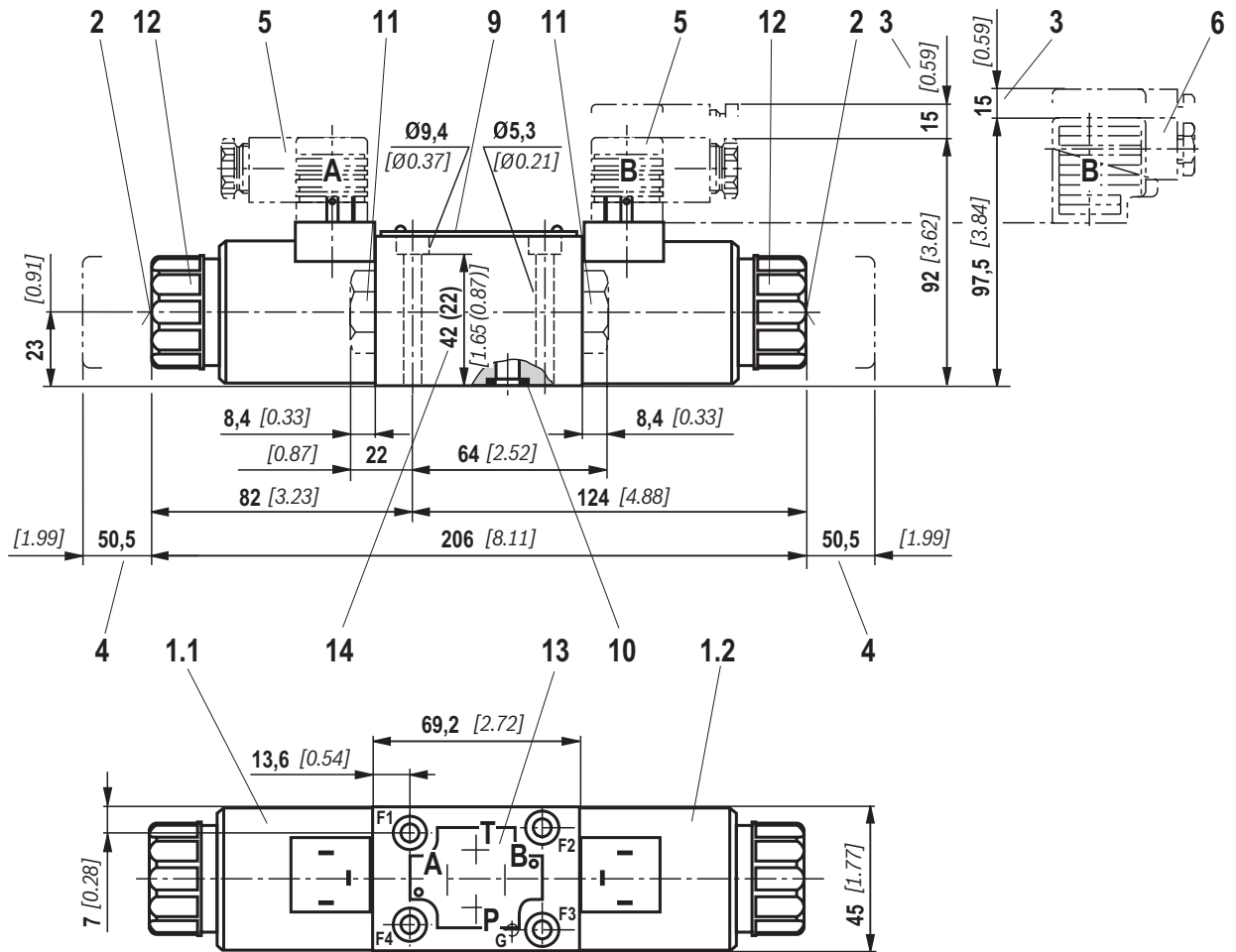

**Item explanations, valve mounting screws and subplates**  
see page 11.

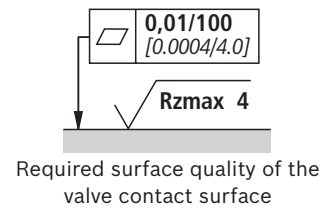

**Dimensions:** Central connection  
(dimensions in mm [inch])

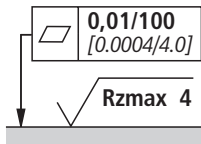
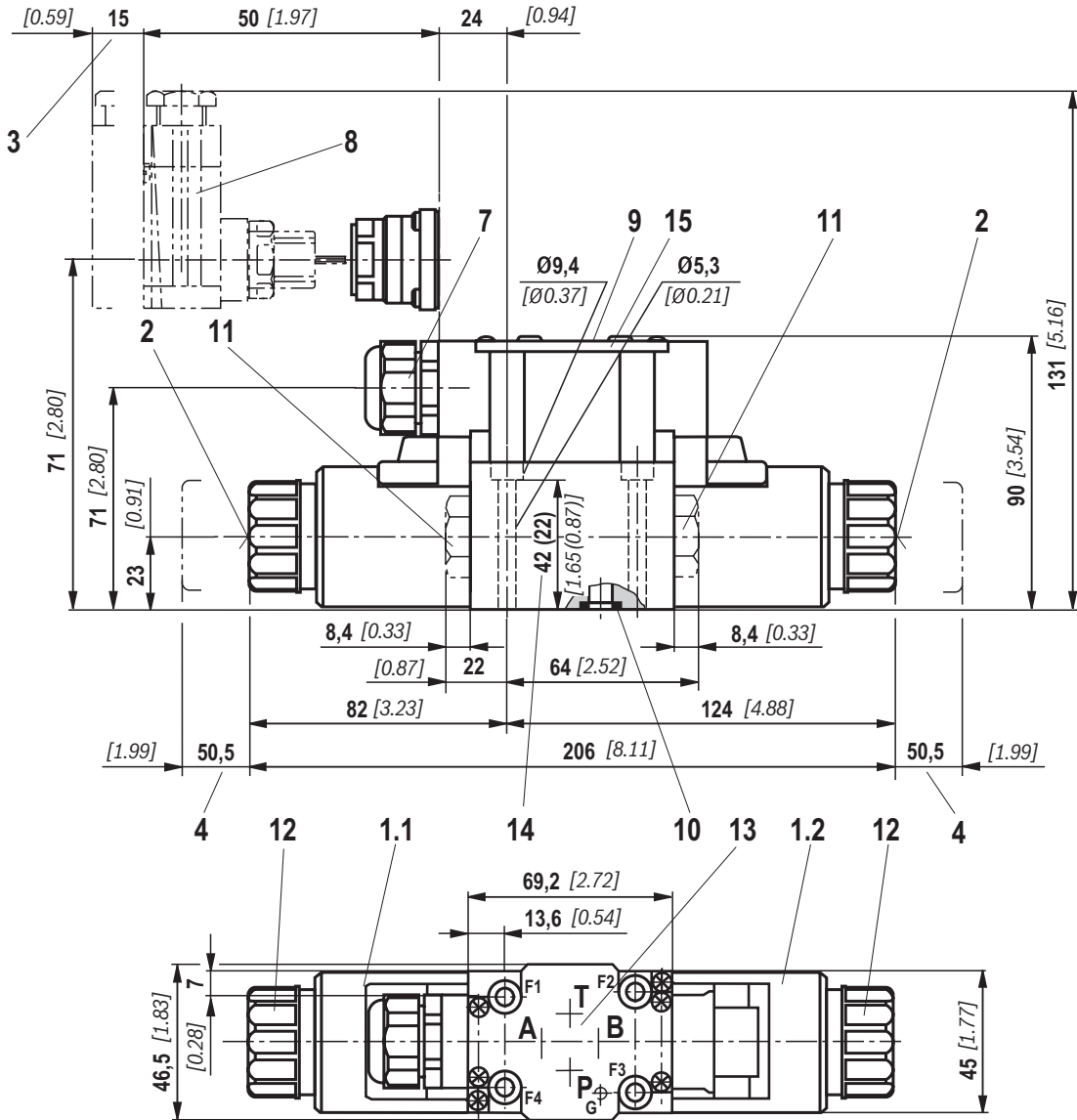

Required surface quality of the valve contact surface

**Terminal assignment with central connection:**

- ▶ **1 solenoid:**  
Always connect the solenoid to terminals 1 and 2, protective grounding conductor to terminal  $\ominus$  PE
- ▶ **2 solenoids:**  
Connect solenoid "a" to terminals 1 and 2, solenoid "b" to terminals 3 and 4, protective grounding conductor to terminal  $\ominus$  PE

**Item explanations, valve mounting screws and subplates** see page 11.

## Dimensions

- 1.1 Solenoid "a"
- 1.2 Solenoid "b"
  - 2 Concealed manual override "N9"
  - 3 Space required to remove the mating connector/angled socket
  - 4 Space required to remove the coil
  - 5 Mating connector **without** circuitry (separate order, see page 12 and data sheet 08006)
  - 6 Mating connector **with** circuitry (separate order, see page 12 and data sheet 08006)
  - 7 Cable gland Pg 16 [1/2" NPT] "DL"
  - 8 Mating connector for connector "DK6L"(separate order, see data sheet 08006)
  - 9 Name plate
- 10 Identical seal rings for ports A, B, P, T
- 11 Plug screw for valves with one solenoid
- 12 Mounting nut, tightening torque  $M_A = 4 \text{ Nm}$  [2.95 ft-lbs]
- 13 Porting pattern according to DIN 24340 form A (**without** locating hole), or ISO 4401-03-02-0-05 and NFPA T3.5.1 R2-2002 D03 (**with** locating hole for locking pin ISO 8752-3x8-St, material no. **R900005694**, separate order)
- 14 Alternative clamping length ( ): 22 mm [0.87 inch]
- 15 Cover

**Attention!** The valve may only be operated with properly mounted cover!

**Subplates** according to data sheet 45052 (separate order)

<b>(without</b> locating hole)	G 341/01 (G1/4)
	G 342/01 (G3/8)
	G 502/01 (G1/2)
<b>(with</b> locating hole)	G 341/60 (G1/4)
	G 342/60 (G3/8)
	G 502/60 (G1/2)
	G 341/12 (SAE-6) <sup>1)</sup>
	G 342/12 (SAE-8) <sup>1)</sup>
	G 502/12 (SAE-10) <sup>1)</sup>

<sup>1)</sup> Upon request

**Valve mounting screws** (separate order)

► Clamping length 42 mm:

**4 metric hexagon socket head cap screws**

**ISO 4762 - M5 x 50 - 10.9-flZn-240h-L**

(friction coefficient  $\mu_{\text{tot}} = 0.09$  to 0.14);

tightening torque  $M_A = 7 \text{ Nm}$  [5.2 ft-lbs]  $\pm 10 \%$ ,

material no. **R913000064**

or

**4 hexagon socket head cap screws**

**ISO 4762 - M5 x 50 - 10.9** (self-procurement)

(friction coefficient  $\mu_{\text{tot}} = 0.12$  to 0.17);

tightening torque  $M_A = 8.1 \text{ Nm}$  [6 ft-lbs]  $\pm 10 \%$

**4 hexagon socket head cap screws UNC 10-24 UNC x 2" ASTM-A574**

(friction coefficient  $\mu_{\text{tot}} = 0.19$  to 0.24);

tightening torque  $M_A = 11 \text{ Nm}$  [8.2 ft-lbs]  $\pm 15 \%$ ,

(friction coefficient  $\mu_{\text{tot}} = 0.12$  to 0.17);

tightening torque  $M_A = 8 \text{ Nm}$  [5.9 ft-lbs]  $\pm 10 \%$ ,

material no. **R978800693**

► Clamping length 22 mm:

**4 metric hexagon socket head cap screws**

**ISO 4762 - M5 x 30 - 10.9-flZn-240h-L**

(friction coefficient  $\mu_{\text{tot}} = 0.09$  to 0.14);

tightening torque  $M_A = 7 \text{ Nm}$  [5.2 ft-lbs]  $\pm 10 \%$ ,

material no. **R913000316**

or

**4 hexagon socket head cap screws**

**ISO 4762 - M5 x 30 - 10.9** (self-procurement)

(friction coefficient  $\mu_{\text{tot}} = 0.12$  to 0.17);

tightening torque  $M_A = 8.1 \text{ Nm}$  [6 ft-lbs]  $\pm 10 \%$

**4 hexagon socket head cap screws UNC 10-24 UNC x 1 1/4"**

(friction coefficient  $\mu_{\text{tot}} = 0.19$  to 0.24);

tightening torque  $M_A = 11 \text{ Nm}$  [8.2 ft-lbs]  $\pm 15 \%$ ,

(friction coefficient  $\mu_{\text{tot}} = 0.12$  to 0.17);

tightening torque  $M_A = 8 \text{ Nm}$  [5.9 ft-lbs]  $\pm 10 \%$ ,

material no. **R978802879**

## Mating connectors according to DIN EN 175301-803

For details and more mating connectors see data sheet 08006

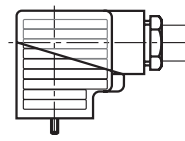
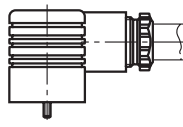

Port	Valve side	Color	Material number				
			without circuitry	with indicator light 12 ... 240 V	with indicator light and rectifier 12 ... 240 V	with rectifier 12 ... 240 V	with indicator light and Zener diode suppression circuit 24 V
M16 x 1.5	a	Gray	<b>R901017010</b>	-	-	-	-
	b	Black	<b>R901017011</b>	-	-	-	-
	a/b	Black	-	<b>R901017022</b>	<b>R901017029</b>	<b>R901017025</b>	<b>R901017026</b>
1/2" NPT (Pg 16)	a	Red/brown	<b>R900004823</b>	-	-	-	-
	b	Black	<b>R900011039</b>	-	-	-	-
	a/b	Black	-	<b>R900057453</b>	<b>R900057455</b>	<b>R900842566</b>	-

## More information

- ▶ Subplates Data sheet 45052
- ▶ Directional spool valve (standard) Data sheet 23178
- ▶ Mineral oil-based hydraulic fluids Data sheet 90220
- ▶ Reliability characteristics according to EN ISO 13849 Data sheet 08012
- ▶ Directional spool and seat valves with electrical actuation and M12x1 plug-in connection Data sheet 08010
- ▶ Mating connectors and cable sets for valves and sensors Data sheet 08006
- ▶ General product information on hydraulic products Data sheet 07008
- ▶ Installation, commissioning and maintenance of industrial valves Data sheet 07300
- ▶ Hydraulic valves for industrial applications Data sheet 07600-B
- ▶ Selection of the filters [www.boschrexroth.com/filter](http://www.boschrexroth.com/filter)

Bosch Rexroth AG  
Hydraulics  
Zum Eisengießer 1  
97816 Lohr am Main, Germany  
Phone +49 (0) 93 52/18-0  
[documentation@boschrexroth.de](mailto:documentation@boschrexroth.de)  
[www.boschrexroth.de](http://www.boschrexroth.de)

© This document, as well as the data, specifications and other information set forth in it, are the exclusive property of Bosch Rexroth AG. It may not be reproduced or given to third parties without its consent.  
The data specified above only serve to describe the product. No statements concerning a certain condition or suitability for a certain application can be derived from our information. The information given does not release the user from the obligation of own judgment and verification. It must be remembered that our products are subject to a natural process of wear and aging.