

Filter element, two-stage

Type 73. Filter elements

RE 51458

Edition: 11.13

Replaces 08.13



- ▶ Size 0110 to 0270
- ▶ Collapse pressure resistance up to 30 bar [435 psi]
- ▶ Filter rating: 3 to 10 μm
- ▶ Filter area: up to 4.8 m² [up to 7440 in²]
- ▶ Operating temperature: -10 °C to 100 °C [14 °F to 212 °F]

Features

- ▶ Low initial pressure differential (ISO 3968)
- ▶ Special filter element design with two filtration stages for wind turbines
- ▶ High dirt holding capacity and filtration performance due to multi-layer glass fiber technology and a low initial pressure differential (ISO 3968)
- ▶ Highly efficient filter materials

Contents

| | |
|--|---------|
| Features | 1 |
| Ordering code | 2 |
| Preferred types | 2 |
| Function, section | 3 |
| Filter variables | 4 |
| Filter media, technical data | 5 ... 7 |
| Compatibility with hydraulic fluids | 7 |
| Installation, commissioning, maintenance | 8 |
| Directives and standardization | 8 |

Ordering code

of the type 73 filter element.

| | | | | | | |
|-----|----|----|----|----|----|---------|
| 01 | 02 | 03 | 04 | 05 | 06 | 07 |
| 73. | | | - | A | 00 | - 0 - M |

Filter element

| | | |
|----|--------|-----|
| 01 | Design | 73. |
|----|--------|-----|

Size

| | | |
|----|-------------------------------|------|
| 02 | According to Rexroth standard | 0110 |
| | | 0120 |
| | | 0135 |
| | | 0145 |
| | | 0200 |
| | | 0270 |

Filter rating in μm

| | | | | | |
|----|----------------|-----------|--|--|-----|
| 03 | Filter element | 1st stage | = main filter, glass fiber media, absolute (ISO 16889) | H3XL | |
| | | | | H6XL | |
| | | | | H10XL | |
| | | 2nd stage | | = Protective filter, stainless steel wire mesh | G25 |
| | | | | | G40 |

Pressure differential

| | | |
|----|--|---|
| 04 | Maximum admissible pressure differential of the filter element: 30 bar [435 psi] | A |
|----|--|---|

Element design

| | | |
|----|-------------------|-------|
| 05 | Standard adhesive | 0... |
| | Standard material | ... 0 |

Bypass valve

| | | |
|----|------------------------------|---|
| 06 | Always 0 with filter element | 0 |
|----|------------------------------|---|

Seal

| | | |
|----|----------|---|
| 07 | NBR seal | M |
|----|----------|---|

Order example:

73.0110 H10XL/G40-A00-0-M

Material no.: R928047823

Preferred types

Filter elements

| Type | Material no. filter element, filter rating in μm | | |
|----------------------------|---|------------|------------|
| | H3XL | H6XL | H10XL |
| 73.0110 H...XL/G40-A00-0-M | R928052428 | R928052434 | R928047823 |
| 73.0120 H...XL/G40-A00-0-M | R928052427 | R928052433 | R928047828 |
| 73.0135 H...XL/G40-A00-0-M | R928052426 | R928052432 | R928047829 |
| 73.0145 H...XL/G40-A00-0-M | R928052425 | R928052431 | R928036180 |
| 73.0200 H...XL/G40-A00-0-M | R928052424 | R928052430 | R928036181 |
| 73.0270 H...XL/G40-A00-0-M | R928052423 | R928052429 | R928036182 |

Function, section

The filter element is the central component of a filter assembly.

The actual filtration process takes place in the filter element. The main filter variables, such as retention capacity, dirt holding capacity and pressure loss are determined by the filter elements and the filter media used in them.

These Rexroth Filter elements are used to filter lubricants in wind turbines. The series 73. filter elements consist of two separate filter elements which are designed in series so fluid flows through one filter followed by the second filter.

In order to achieve the cleanliness class, the outer filter element (1) made of glass fiber media serves as the main filter. The inner filter element (2) made of wire mesh serves as a protective filter in case of a cold start. The outer filter element consists of a multi-layer combination of star-like pleated filter media which are laid around a perforated supporting tube. The inner filter element has the same general design, except the filter material is different.

The bypass valve (3) (see schematic) is located in the filter head of the filter housing.

Possible operating conditions:

1. Normal operation with a clean filter element:

The fluid flows through the outer filter element (1). The bypass valve is closed. When the fluid flows to the filter outlet, it passes the inner filter element (2).

2. Cold start or highly contaminated outer filter element:

A very small portion of the fluid flows through the outer filter element (1). Nearly all of the fluid passes through the bypass valve, which is completely open. Through the open bypass valve (3), dirt particles get to the clean side of the outer filter element (1). But the inner filter element (2) still retains any coarse particles. Therefore, the downstream components are still protected, even under these bypass conditions.

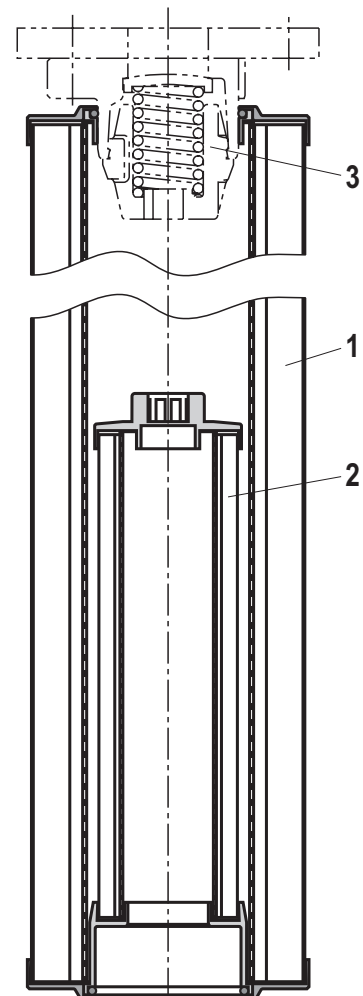

Filter variables

Filter rating and attainable oil cleanliness

The main goal when using industrial filters is not only the direct protection of machine components but also to attain the target oil cleanliness for the system.

Oil cleanliness is defined on the basis of oil cleanliness classes which classify how the amount of particles of the existing contamination is distributed in the operating fluid.

Filter performance

Filtration ratio $\beta_{x(c)}$ (β value)

The retention capacity of hydraulic filters in a hydraulic system is characterized by the filtration ratio $\beta_{x(c)}$. This variable is the most important performance characteristic of a hydraulic filter. It is measured in the multipass test, and is the average value of the specified initial and final differential pressure according to ISO 16889 using ISOMTD test dust.

The filtration ratio $\beta_{x(c)}$ is defined as the ratio of the particle count of the respective particle size on both sides of the filter.

Dirt holding capacity

It is also measured using the multipass test and determines the amount of test dust ISOMTD which is fed to the filter medium until a specified pressure increase has been reached.

Pressure loss (also pressure differential or delta p)

The pressure loss of the filter element is the relevant variable for the determination of the filter size. The pressure loss with a clean filter element is recommended by the filter manufacturer or defined by the system manufacturer. This variable depends on many factors, mainly: The rating of the filter media, its geometry and arrangement in the filter element, the filter area, the operating viscosity of the fluid, and the flow.

The term "delta p" is often also expressed with the symbol " Δp ".

When dimensioning the filter, an initial pressure loss is determined which must not be exceeded by the new filter element based on the the aforementioned conditions.

The following diagram shows the typical pressure loss behavior of filter elements with different filter media at different flows for a viscosity of $30 \text{ mm}^2/\text{s}$ [150 SUS].

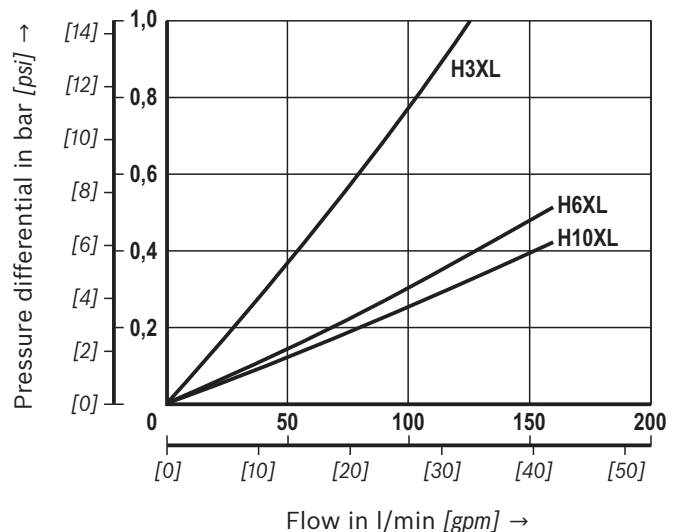
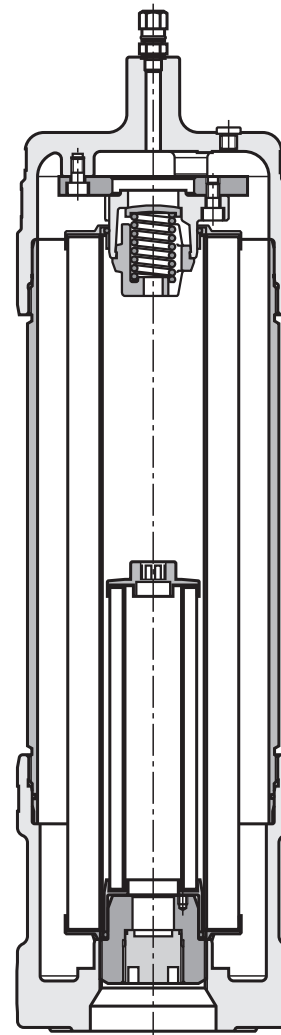

Filter media

Overview

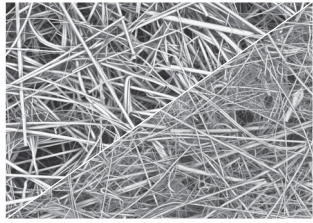
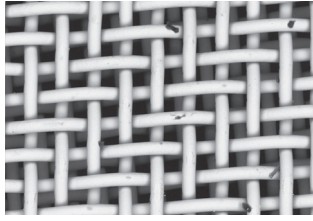
| Filter media/set-up | Electron microscope image |
|---|---|
| H...XL, Micro glass Depth filter, combination of inorganic micro glass filter medium High dirt holding capacity due to multi-layer technology. |  |
| G..., Stainless steel wire mesh Material 1.4401 or 1.4571 Surface filter made of stainless steel wire mesh with supporting tissue. |  |

Technical data

(For applications outside these parameters, please consult us!)

| general | | | | |
|------------------------------------|-------------------|---|--|-------------|
| Ambient temperature range | | °C [°F] | -40 ... +50 [-40 ... +122] | |
| Weight | | Size | 0110 | 0120 |
| | | kg [lbs] | 1.9 [4.2] | 3.3 [7.2] |
| | | Size | 0145 | 0200 |
| | | kg [lbs] | 3.7 [8.1] | 4.3 [9.4] |
| Material | - Cover | Steel (tin-coated) | | |
| | - Base | Aluminum | | |
| | - Filter frame | Steel (tin-coated) | | |
| | - Filter material | Glass fiber media/stainless steel wire mesh | | |
| | - Seal | NBR | | |
| hydraulic | | | | |
| Fluid temperature range | | °C [°F] | -10 ... +100 [+14 to +212] (for short time periods down to -20 [-4]) | |
| Minimum conductivity of the medium | | pS/m | 300 | |
| Filtration direction | | From the outside to the inside | | |

Filter media

Technical data

Glass fiber media, H...XL

If the Rexroth H...XL filter medium is properly dimensioned and applied, it will achieve a high degree of cleanliness for lubricants. Due to its designed retention capacity (ISO 16889), it offers highly effective protection for machine and system components which are sensitive to contamination.

- ▶ H...XL depth filter made of inorganic glass fiber material
- ▶ Absolute filtration/defined retention capacity according to ISO 16889
- ▶ High dirt holding capacity due to multi-layer construction
- ▶ Non-reusable filter (not cleanable due to the depth filtration effect)
- ▶ Attainable oil cleanliness classes according to ISO 4406 up to ISO code 12/8/3 and better

Filter rating and attainable oil cleanliness

| Recommended oil cleanliness according to ISO 4406 [SAE-AS 4059] | Recommended filter medium |
|---|---------------------------|
| ≤ 18/13/10 (5) | H3XL |
| ≤ 19/14/11 (6) | H6XL |
| ≤ 20/16/13 (8) | H10XL |

Filtration ratio $\beta_{x(c)}$ (β value)

Typical β values of up to 2.2 bar [31.9 psi] Δp pressure increase at the filter element ¹⁾

| Filter medium | Particle size "x" for different β values, measurement according to ISO 16889 | | |
|---------------|--|-------------------------|--------------------------|
| | $\beta_{x(c)} \geq 75$ | $\beta_{x(c)} \geq 200$ | $\beta_{x(c)} \geq 1000$ |
| H3XL | 4.0 $\mu\text{m}(c)$ | < 4.5 $\mu\text{m}(c)$ | 5.0 $\mu\text{m}(c)$ |
| H6XL | 4.8 $\mu\text{m}(c)$ | 5.5 $\mu\text{m}(c)$ | 7.5 $\mu\text{m}(c)$ |
| H10XL | 6.5 $\mu\text{m}(c)$ | 7.5 $\mu\text{m}(c)$ | 9.5 $\mu\text{m}(c)$ |

¹⁾ Filtration ratio $\beta_{x(c)}$ for other filter media upon request

Filtration ratio $\beta_{x(c)}$ as a function of the particle size $\mu\text{m}(c)$

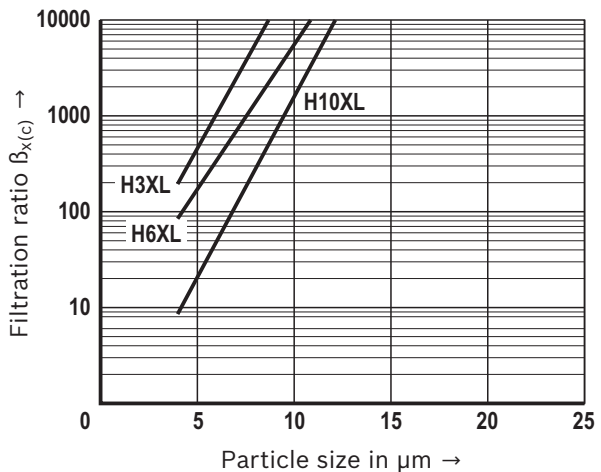

Filter media

For further information regarding Rexroth filter elements as well as to contamination and oil cleanliness control, see our publications or specific brochures (RE 51420).

Dirt holding capacity

Compared to conventional filter media with single layer technology, the Rexroth H...XL micro glass features a high dirt holding capacity because it is made of two separate filter layers connected in series.

Superior dirt holding capacity of H...XL filter elements

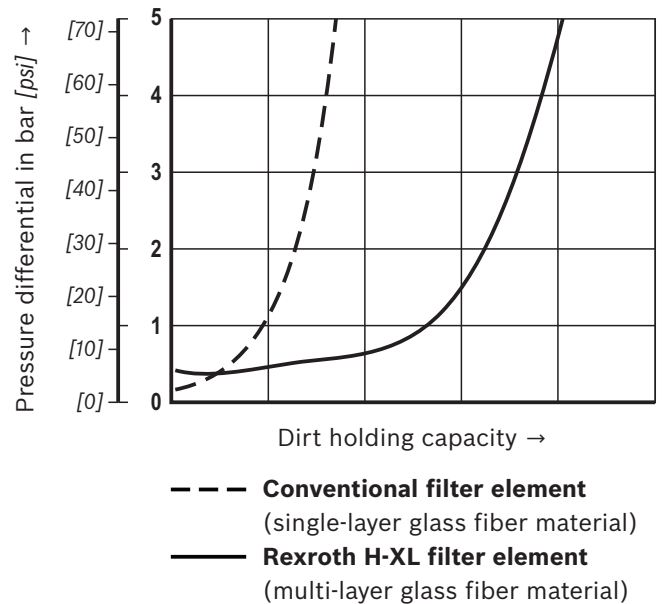

Stainless steel wire mesh, G...

Wire mesh G25 – G40

| Filter medium | Design | Mesh size | Attainable oil cleanliness ¹⁾ |
|---------------|------------|------------|---|
| G25 | Woven mesh | 25 µm nom. | No details, only suitable for coarse filtration (particle size ≥ 25 µm) |
| G40 | Woven mesh | 40 µm nom. | |

¹⁾ According to ISO 4406 for particles ≥ 4 µm(c), ≥ 6 µm(c) and ≥ 14 µm(c)

Compatibility with hydraulic fluids

| Hydraulic fluid | Classification | Suitable sealing materials | Standards |
|-------------------------------------|----------------|----------------------------|------------|
| Mineral oil | HLP | NBR | DIN 51524 |
| Bio-degradable – insoluble in water | HETG | NBR | VDMA 24568 |
| Flame-resistant – containing water | HFAS, HFAE | NBR | DIN 24320 |
| | HFC | NBR | VDMA 24317 |

Important information on hydraulic fluids!

- For more information and data on the use of other hydraulic fluids, please refer to data sheet 90220 or contact us.
- **Flame-resistant - containing water:** Due to possible chemical reactions with materials or surface coatings of machine or system components, the service life with these hydraulic fluids may be less than expected. Filter materials made of filter paper P... (cellulose) may not be used, filter elements with filter materials

made of glass fiber (HydroClean H...XL or wire mesh G...) have to be used instead.

- **Bio-degradable:** If filter materials made of filter paper P... are used instead of HydroClean H...XL, the filter life may be shorter than expected due to incompatibility of materials and swelling.

Installation, commissioning and maintenance

When does the filter element have to be replaced?

As soon as the dynamic pressure or the pressure differential set at the maintenance indicator is reached, the red button of the optical-mechanical maintenance indicator pops out. If there is an electronic switching element, an electric signal provides an output in addition. In this case, the filter element has to be replaced or cleaned. Filter elements should be replaced or cleaned after 6 months at minimum.

Notice!

Depending on the dimensioning of the filter size, the maintenance indicator may reach the set differential pressure or pressure differential during start-up. In this case, the optical-mechanical indicator must be manually reset. The electric signal will stop after the operating temperature has been reached.

If the maintenance indicator signal is ignored, the increasing pressure differential may damage the filter element causing it to collapse.

Replacing filter elements

- Switch off the system and discharge the filter on the pressure side.

Warning:

Filters are containers under pressure. Before opening the filter housing, check whether the system pressure in the filter has been decreased to ambient pressure. Only then may the filter housing be opened for maintenance.

Detailed instructions with regard to the replacement of filter elements can be found on the data sheet of the relevant filter series.

Directives and standardization

Rexroth filter elements are tested and quality-monitored according to various ISO test standards:

| | |
|--|-------------------|
| Filter performance test (multipass test) | ISO 16889:2008-06 |
| Δp (pressure loss) characteristic curves | ISO 3968:2001-12 |
| Compatibility with hydraulic fluid | ISO 2943:1998-11 |
| Collapse pressure test | ISO 2941:2009-04 |

The development, manufacture and assembly of Rexroth industrial filters and Rexroth filter elements is carried out within the framework of a certified quality management system in accordance with ISO 9001:2000.

Bosch Rexroth AG
Werk Ketsch
Hardtwaldstr. 43
68775 Ketsch, Germany
Telefon +49 (0) 62 02/603-0
filter-support@boschrexroth.de
www.boschrexroth.de

© This document, as well as the data, specifications and other information set forth in it, are the exclusive property of Bosch Rexroth AG. It may not be reproduced or given to third parties without its consent. The data specified above only serve to describe the product. No statements concerning a certain condition or suitability for a certain application can be derived from our information. The information given does not release the user from the obligation of own judgment and verification. It must be remembered that our products are subject to a natural process of wear and aging.