

# Linear Sensor Indicator K3HB-S

CSM\_K3HB-S\_DS\_E\_11\_4



## Linear Sensor Indicator for High-speed, High-precision Measurement and Discrimination

- Easy recognition of judgement results using color display that can be switched between red and green. \*
- Equipped with a position meter that represents measured amounts and relative positions.
- Develop a variety of measurement and discrimination applications using external event inputs.
- Series expanded to include DeviceNet models.
- Short body with depth of only 95 mm (from behind the front panel), or 97 mm for DeviceNet models.
- UL certification approval (Certification Mark License).
- CE Marking conformance by third party assessment body.
- Water-resistant enclosure conforms to NEMA 4X (equivalent to IP66).
- \* Visual confirmation of judgement results is not supported on models that do not have an output or models that do not support DeviceNet.  
You can change the display color by setting it, but you cannot switch it based on the judgement results.



For the most recent information on models that have been certified for safety standards, refer to your OMRON website.

Refer to *Safety Precautions for All Digital Panel Meters*.

## Model Number Structure

### Model Number Legend

Base Units and Optional Boards can be ordered individually or as sets.

#### Base Units

K3HB-S    
1 5

#### 1. Input Sensor Code

SD: DC Process input

#### 5. Supply Voltage

100-240 VAC: 100 to 240 VAC  
24 VAC/VDC: 24 VAC/VDC

#### Base Units with Optional Boards

K3HB-S  -      
1 2 3 4 5

#### 2. Sensor Power Supply/Output Type Code

- None: None
- CPA: Relay output (PASS: SPDT) + Sensor power supply (12 VDC +/-10%, 80 mA) (See note 1.)
- L1A: Linear current output (0 to 20 or 4 to 20 mA DC) + Sensor power supply (12 VDC +/-10%, 80 mA) (See note 2.)
- L2A: Linear voltage output (0 to 5, 1 to 5, or 0 to 10 VDC) + Sensor power supply (12 VDC +/-10%, 80 mA) (See note 2.)
- A: Sensor power supply (12 VDC +/-10%, 80 mA)
- FLK1A: Communications (RS-232C) + Sensor power supply (12 VDC +/-10%, 80 mA) (See note 2.)
- FLK3A: Communications (RS-485) + Sensor power supply (12 VDC +/-10%, 80 mA) (See note 2.)

- Note:** 1. CPA can be combined with relay outputs only.  
2. Only one of the following can be used by each Digital Indicator: RS-232C/RS-485 communications, a linear output, or DeviceNet communications.

#### Optional Board

##### Sensor Power Supply/Output Boards

K33-   
2

##### Relay/Transistor Output Boards

K34-   
3

##### Event Input Boards

K35-   
4

**Note:** The following combinations are not possible.

- Communications (FLK  A) + DeviceNet (DRT)
- Communications (FLK  A) + BCD output (BCD)
- Linear current/voltage (L  A) + DeviceNet (DRT)

#### 3. Relay/Transistor Output Type Code

- None: None
- C1: Relay contact (H/L: SPDT each)
- C2: Relay contact (HH/H/LL/L: SPST-NO each)
- T1: Transistor (NPN open collector: HH/H/PASS/L/LL)
- T2: Transistor (PNP open collector: HH/H/PASS/L/LL)
- BCD \*: BCD output + transistor output (NPN open collector: HH/H/PASS/L/LL)
- DRT: DeviceNet (See note 2.)
- \* A Special BCD Output Cable (sold separately) is required.

#### 4. Event Input Type Code

- None: None
- 1: 5 inputs (M3 terminal blocks), NPN open collector
- 2 \*: 8 inputs (10-pin MIL connector), NPN open collector
- 3: 5 inputs (M3 terminal blocks), PNP open collector
- 4 \*: 8 inputs (10-pin MIL connector), PNP open collector
- \* There is no bank selection for "None" and "DeviceNet" types of "Transistor Output Type Code".

## Accessories (Sold Separately)

K32-DICN: Special Cable (for event inputs, with 8-pin connector)

K32-BCD: Special BCD Output Cable

## Watertight Cover

| Model    |
|----------|
| Y92A-49N |

## Rubber Packing

| Model  |
|--------|
| K32-P1 |

**Note:** Rubber packing is provided with the Controller.

# Specifications

## ■ Ratings

|  |   |   |
|--|---|---|
| <b>Power supply voltage</b>                  |   | 100 to 240 VAC (50/60 Hz), 24 VAC/VDC, DeviceNet power supply: 24 VDC   |
| <b>Allowable power supply voltage range</b>  |   | 85% to 110% of the rated power supply voltage, DeviceNet power supply: 11 to 25 VDC   |
| <b>Power consumption (See note 1.)</b>       |   | 100 to 240 V: 18 VA max. (max. load)<br>24 VAC/DC: 11 VA/7 W max. (max. load)   |
| <b>Current consumption</b>                   |   | DeviceNet power supply: 50 mA max. (24 VDC)   |
| <b>Input</b>                                 |   | DC voltage/current  |
| <b>A/D conversion method</b>                 |   | Sequential comparison system  |
| <b>External power supply</b>                 |   | 12 VDC $\pm$ 10%, 80 mA (models with external power supply only)  |
| <b>Event inputs (See note 2.)</b>            | <b>Timing input</b>                     | NPN open collector or no-voltage contact signal<br>ON residual voltage: 3 V max.<br>ON current at 0 $\Omega$ : 17 mA max.<br>Max. applied voltage: 30 VDC max.<br>OFF leakage current: 1.5 mA max.  |
|  | <b>Startup compensation timer input</b> | NPN open collector or no-voltage contact signal<br>ON residual voltage: 2 V max.  |
|  | <b>Hold input</b>                       | ON current at 0 $\Omega$ : 4 mA max.  |
|  | <b>Reset input</b>                      | Max. applied voltage: 30 VDC max.<br>OFF leakage current: 0.1 mA max.   |
|  | <b>Forced-zero input</b>                |   |
| <b>Output ratings (depends on the model)</b> | <b>Relay output</b>                     | 250 VAC, 30 VDC, 5 A (resistive load)<br>Mechanical life expectancy: 5,000,000 operations, Electrical life expectancy: 100,000 operations   |
|  | <b>Transistor output</b>                | Maximum load voltage: 24 VDC, Maximum load current: 50 mA, Leakage current: 100 $\mu$ A max.  |
|  | <b>Linear output</b>                    | Linear output 0 to 20 mA DC, 4 to 20 mA DC:<br>Load: 500 $\Omega$ max, Resolution: Approx. 10,000, Output error: $\pm$ 0.5% FS<br>Linear output 0 to 5 VDC, 1 to 5 VDC, 0 to 10 VDC:<br>Load: 5 k $\Omega$ max, Resolution: Approx. 10,000, Output error: $\pm$ 0.5% FS<br>(1 V or less: $\pm$ 0.15 V; no output for 0 V or less)                         |
| <b>Display method</b>                        |   | Negative LCD (backlit LED) display<br>7-segment digital display (Character height: PV: 14.2 mm (green/red); SV: 4.9 mm (green))   |
| <b>Main functions</b>                        |   | Scaling function, 2-input calculation function, measurement operation selection, averaging, previous average value comparison, forced-zero, zero-limit, output hysteresis, output OFF delay, output test, teaching, display value selection, display color selection, key protection, bank selection, display refresh period, maximum/minimum hold, reset |
| <b>Ambient operating temperature</b>         |   | -10 to 55°C (with no icing or condensation)   |
| <b>Ambient operating humidity</b>            |   | 25% to 85%  |
| <b>Storage temperature</b>                   |   | -25 to 65°C (with no icing or condensation)   |
| <b>Altitude</b>                              |   | 2,000 m max.  |
| <b>Accessories</b>                           |   | Watertight packing, 2 fixtures, terminal cover, unit stickers, instruction manual. DeviceNet models also include a DeviceNet connector (Hirose HR31-5.08P-5SC(01)) and crimp terminals (Hirose HR31-SC-121) (See note 3.)   |

**Note: 1.** DC power supply models require a control power supply capacity of approximately 1 A per Unit when power is turned ON. Particular attention is required when using two or more DC power supply models. The OMRON S8VS-series DC Power Supply Unit is recommended.

**2.** PNP input types are also available.

**3.** For K3HB-series DeviceNet models, use only the DeviceNet Connector included with the product. The crimp terminals provided are for Thin Cables.

## ■ Characteristics

|  |             |   |
|--|-------------|---|
| Display range  |             | -19,999 to 99,999   |
| Sampling period  |             | One input: 0.5 ms; Two inputs: 1.0 ms   |
| Comparative output response times (transistor outputs) | One input   | OFF to ON: 1 ms max., ON to OFF: 1.5 ms max.<br>(The time until the comparative output is output when there is a forced sudden change in the input signal from 15% to 95% or 95% to 15%.)   |
|  | Two inputs  | OFF to ON: 2 ms max., ON to OFF: 2.5 ms max.<br>(The time until the comparative output is output when there is a forced sudden change in the input signal from 15% to 95% or 95% to 15%.)   |
| Linear output response time                            | One input   | 51 ms max.<br>(The time until the final analog output is reached when there is a forced sudden change in the input signal from 15% to 95% or 95% to 15%.)   |
|  | Two inputs  | 52 ms max.<br>(The time until the final analog output is reached when there is a forced sudden change in the input signal from 15% to 95% or 95% to 15%.)   |
| Insulation resistance                                  |             | 20 M $\Omega$ min. (at 500 VDC)   |
| Dielectric strength                                    |             | 2,300 VAC for 1 min between external terminals and case   |
| Noise immunity   |             | 100 to 240 VAC models:<br>±1,500 V at power supply terminals in normal or common mode<br>(waveform with 1-ns rising edge and pulse width of 1 $\mu$ s/100 ns)<br>24 VAC/VDC models:<br>±1,500 V at power supply terminals in normal or common mode<br>(waveform with 1-ns rising edge and pulse width of 1 $\mu$ s/100 ns)  |
| Vibration resistance                                   |             | Frequency: 10 to 55 Hz; Acceleration: 50 m/s <sup>2</sup> , 10 sweeps of 5 min each in X, Y, and Z directions   |
| Shock resistance                                       |             | 150 m/s <sup>2</sup> (100 m/s <sup>2</sup> for relay outputs) 3 times each in 3 axes, 6 directions  |
| Weight   |             | Approx. 300 g (Base Unit only)  |
| Degree of protection                                   | Front panel | Conforms to NEMA 4X for indoor use (equivalent to IP66)   |
|  | Rear case   | IP20  |
|  | Terminals   | IP00 + finger protection (VDE0106/100)  |
| Memory protection                                      |             | EEPROM (non-volatile memory)<br>Number of rewrites: 100,000   |
| Applicable standards                                   |             | UL61010-1, CSA C22.2 No. 61010-1-04<br>EN61010-1 (IEC61010-1): Pollution degree 2/Overvoltage category II<br>EN61326-1  |
| EMC  |             | EMI: EN61326-1 Industrial electromagnetic environment<br>Electromagnetic radiation interference<br>CISPR 11 Group 1, Class A<br>Terminal interference voltage<br>CISPR 11 Group 1, Class A<br>EMS: EN61326-1 Industrial electromagnetic environment<br>Electrostatic Discharge Immunity<br>EN61000-4-2: 4 kV (contact), 8 kV (in air)<br>Radiated Electromagnetic Field Immunity<br>EN61000-4-3: 10 V/m 1 kHz sine wave amplitude modulation (80 MHz to 1 GHz, 1.4 to 2 GHz)<br>Electrical Fast Transient/Burst Immunity<br>EN61000-4-4: 2 kV (power line), 1 kV (I/O signal line)<br>Surge Immunity<br>EN61000-4-5: 1 kV with line (power line), 2 kV with ground (power line)<br>Conducted Disturbance Immunity<br>EN61000-4-6: 3 V (0.15 to 80 MHz)<br>Power Frequency Magnetic Immunity<br>EN61000-4-8: 30 A/m (50 Hz) continuous time<br>Voltage Dips and Interruptions Immunity<br>EN61000-4-11: 0.5 cycle, 0°/180°, 100% (rated voltage) |

## ■ Input Ranges (Measurement Ranges and Accuracy)

| Input                                | Input type | Measurement range  | Indication range    | Input impedance   | Accuracy (at 23±5°C)                      | Maximum absolute rated input               |
|--------------------------------------|------------|--------------------|---------------------|-------------------|---|--|
| K3HB-SSD<br>DC voltage/current input | 0 to 20 mA | 0.000 to 20.000 mA | -2.000 to 22.000 mA | 120 $\Omega$ max. | One input:<br>±0.1% F.S.<br>±1 digit max. | ±31 mA                                     |
|                                      | 4 to 20 mA | 4.000 to 20.000 mA | 2.000 to 22.000 mA  | 1 M $\Omega$ min. |   | Two inputs:<br>±0.2% F.S.<br>±1 digit max. |
|                                      | 0 to 5 V   | 0.000 to 5.000 V   | -0.500 to 5.500 mA  |                   |   |  |
|                                      | 1 to 5 V   | 1.000 to 5.000 V   | 0.500 to 5.500 V    |                   |   |  |
|                                      | ±5 V       | ±5.000 V           | ±5.500 V            |                   |   |  |
|                                      | ±10 V      | ±10.000 V          | ±11.000 V           |                   | ±14.5 V                                   |  |

**Note:** The accuracy is for an ambient temperature of 23±5°C.

| Input type            |        | DC current input |        | Input type           |        | DC voltage input |        |         |        |
|-----------------------|--------|------------------|--------|----------------------|--------|------------------|--------|---------|--------|
| Connected terminals   |        | 0-20             | 4-20   | Connected terminals  |        | 0-5              | 1-5    | 5       | 10     |
| Input A               |        | E2 - E3          |        | Input A              |        | E4 - E3          |        |         |        |
| Input B               |        | E1 - E3          |        | Input B              |        | E5 - E3          |        |         |        |
| DC current range (mA) | 24.000 | 22.000           | 22.000 | DC voltage range (V) |        |                  |        |         |        |
|                       | 20.000 |                  |        |                      | 10.000 | 5.500            | 5.500  | 5.500   | 11.000 |
|                       | 16.000 |                  |        |                      | -0.500 | 0.500            |        |         |        |
|                       | 12.000 |                  |        |                      |        |                  | -5.500 |         |        |
|                       | 8.000  |                  |        |                      |        |                  |        |         |        |
|                       | 4.000  |                  |        |                      |        |                  |        |         |        |
|                       | 0.000  |                  | 2.000  |                      |        |                  |        |         |        |
|                       | -4.000 | -2.000           |        |                      |        |                  |        | -11.000 |        |

The range shown in dark shading indicates the factory setting.

## Sampling and Comparative Output Response Times

The K3HB-S sampling and comparative output response times depend on the calculation methods, timing hold type, and, for simple averaging, the averaging times. Refer to the following description for details.

### Output Refresh Period

The K3HB-S repeats input reads, calculation, and judgement output processing. The output refresh period differs depending on whether there are one or two inputs, as outlined below.

#### One Input

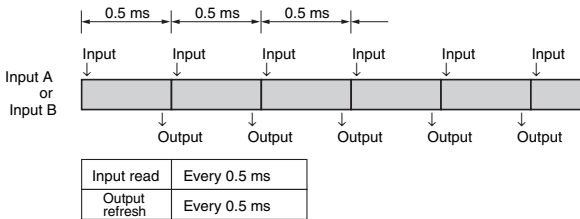

#### Two inputs

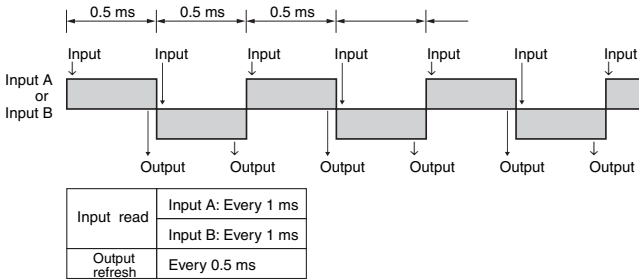

### Output Response Time

The comparative output response time is the sum of the data processing time and the output (relay or transistor) response time.

#### One Input

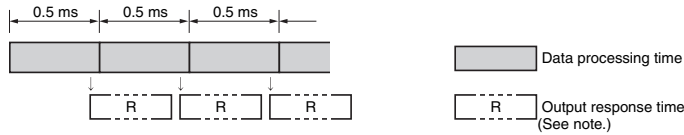

#### Two Inputs

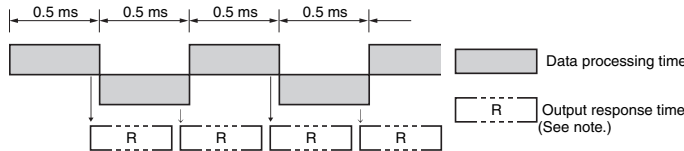

**Note:** For transistor outputs:  
 For one input: OFF to ON 1 ms and ON to OFF 1.5 ms  
 For two inputs: OFF to ON 2 ms and ON to OFF 2.5 ms  
 For relay outputs:  
 The relay operation time of 15 ms is added to the transistor output response times.

# Common Specifications

## ■ Event Input Ratings

| Input type | S-TMR, HOLD, RESET, ZERO, BANK1, BANK2, BANK4  | TIMING  |
|------------|--|---|
| Contact    | ON: 1 kΩ max., OFF: 100 kΩ min.  | ---   |
| No-contact | ON residual voltage: 2 V max.<br>OFF leakage current: 0.1 mA max.<br>Load current: 4 mA max.<br>Maximum applied voltage: 30 VDC max. | ON residual voltage: 3 V max.<br>OFF leakage current: 1.5 mA max.<br>Load current: 17 mA max.<br>Maximum applied voltage: 30 VDC max. |

## ■ Output Ratings

### Contact Output

| Item                       | Resistive loads<br>(250 VAC, $\cos\phi=1$ ;<br>30 VDC, L/R=0 ms) | Inductive loads<br>(250 VAC, closed<br>circuit, $\cos\phi=0.4$ ;<br>30 VDC, L/R=7 ms) |
|----------------------------|--|---|
| Rated load                 | 5 A at 250 VAC<br>5 A at 30 VDC                                  | 1 A at 250 VAC<br>1 A at 30 VDC   |
| Mechanical life expectancy | 5,000,000 operations   |   |
| Electrical life expectancy | 100,000 operations   |   |

### Transistor Output

|                      |             |
|----------------------|-------------|
| Maximum load voltage | 24 VDC      |
| Maximum load current | 50 mA       |
| Leakage current      | 100 μA max. |

### Linear Output

| Item                     | 0 to 20 mA     | 4 to 20 mA | 0 to 5 V  | 1 to 5 V | 0 to 10 V |
|--------------------------|----------------|------------|---|----------|-----------|
| Allowable load impedance | 500 Ω max.     |            | 5 kΩ min.   |          |           |
| Resolution               | Approx. 10,000 |            |   |          |           |
| Output error             | ±0.5%FS        |            | ±0.5%FS (1 V or less: no output for ±0.15 V; 0 V or less) |          |           |

### Serial Communications Output

| Item                   | RS-232C, RS-485              |
|------------------------|------------------------------|
| Communications method  | Half duplex                  |
| Synchronization method | Start-stop synchronization   |
| Baud rate              | 9,600, 19,200, or 38,400 bps |
| Transmission code      | ASCII                        |
| Data length            | 7 bits or 8 bits             |
| Stop bit length        | 2 bits or 1 bit              |
| Error detection        | Vertical parity and FCS      |
| Parity check           | Odd, even                    |

**Note:** For details on serial and DeviceNet communications, refer to the *Digital Indicator K3HB Communications User's Manual* (Cat.No. N129).

### BCD Output I/O Ratings (Input Signal Logic: Negative)

| I/O signal name |                      | Item                               | Rating                   |
|-----------------|----------------------|------------------------------------|--------------------------|
| Inputs          | REQUEST              | Input signal                       | No-voltage contact input |
|                 | HOLD                 | Input current for no-voltage input | 10 mA                    |
|                 | MAX                  | Signal level                       | ON voltage               |
|                 | MIN                  |                                    | OFF voltage              |
| RESET           |                      | 1.5 V max.<br>3 V min.             |                          |
| Outputs         | DATA                 | Maximum load voltage               | 24 VDC                   |
|                 | POLARITY             | Maximum load current               | 10 mA                    |
|                 | OVER                 | Leakage current                    | 100 μA max.              |
|                 | DATA VALID           |                                    |                          |
|                 | RUN                  |                                    |                          |
|                 |                      |                                    |                          |
| HH              | H<br>PASS<br>L<br>LL | Maximum load voltage               | 24 VDC                   |
|                 |                      | Maximum load current               | 50 mA                    |
|                 |                      | Leakage current                    | 100 μA max.              |
|                 |                      |                                    |                          |

**Note:** For details on serial and DeviceNet communications, refer to the *Digital Indicator K3HB Communications User's Manual* (Cat.No. N129).

**DeviceNet Communications**

| <b>Communications protocol</b>             |                                  | Conforms to DeviceNet  |                               |                       |                         |                               |          |               |     |      |          |               |     |      |          |               |     |       |
|--|----------------------------------|--|-------------------------------|-----------------------|-------------------------|-------------------------------|----------|---------------|-----|------|----------|---------------|-----|------|----------|---------------|-----|-------|
| <b>Supported communications</b>            | <b>Remote I/O communications</b> | Master-Slave connection (polling, bit-strobe, COS, cyclic)<br>Conforms to DeviceNet communications standards.  |                               |                       |                         |                               |          |               |     |      |          |               |     |      |          |               |     |       |
|  | <b>I/O allocations</b>           | Allocate any I/O data using the Configurator.<br>Allocate any data, such as DeviceNet-specific parameters and variable area for Digital Indicators.<br>Input area: 2 blocks, 60 words max.<br>Output area: 1 block, 29 words max.<br>(The first word in the area is always allocated for the Output Execution Enabled Flags.)  |                               |                       |                         |                               |          |               |     |      |          |               |     |      |          |               |     |       |
|  | <b>Message communications</b>    | Explicit message communications<br>CompoWay/F communications commands can be executed (using explicit message communications)  |                               |                       |                         |                               |          |               |     |      |          |               |     |      |          |               |     |       |
| <b>Connection methods</b>                  |                                  | Combination of multi-drop and T-branch connections (for trunk and drop lines)  |                               |                       |                         |                               |          |               |     |      |          |               |     |      |          |               |     |       |
| <b>Baud rate</b>                           |                                  | DeviceNet: 500, 250, or 125 Kbps (automatic follow-up)   |                               |                       |                         |                               |          |               |     |      |          |               |     |      |          |               |     |       |
| <b>Communications media</b>                |                                  | Special 5-wire cable (2 signal lines, 2 power supply lines, 1 shield line)   |                               |                       |                         |                               |          |               |     |      |          |               |     |      |          |               |     |       |
| <b>Communications distance</b>             |                                  | <table border="1"> <thead> <tr> <th>Baud rate</th> <th>Network length (max.)</th> <th>Drop line length (max.)</th> <th>Total drop line length (max.)</th> </tr> </thead> <tbody> <tr> <td>500 Kbps</td> <td>100 m (100 m)</td> <td>6 m</td> <td>39 m</td> </tr> <tr> <td>250 Kbps</td> <td>100 m (250 m)</td> <td>6 m</td> <td>78 m</td> </tr> <tr> <td>125 Kbps</td> <td>100 m (500 m)</td> <td>6 m</td> <td>156 m</td> </tr> </tbody> </table> <p>The values in parentheses are for Thick Cable.</p> | Baud rate                     | Network length (max.) | Drop line length (max.) | Total drop line length (max.) | 500 Kbps | 100 m (100 m) | 6 m | 39 m | 250 Kbps | 100 m (250 m) | 6 m | 78 m | 125 Kbps | 100 m (500 m) | 6 m | 156 m |
| Baud rate                                  | Network length (max.)            | Drop line length (max.)  | Total drop line length (max.) |                       |                         |                               |          |               |     |      |          |               |     |      |          |               |     |       |
| 500 Kbps                                   | 100 m (100 m)                    | 6 m  | 39 m                          |                       |                         |                               |          |               |     |      |          |               |     |      |          |               |     |       |
| 250 Kbps                                   | 100 m (250 m)                    | 6 m  | 78 m                          |                       |                         |                               |          |               |     |      |          |               |     |      |          |               |     |       |
| 125 Kbps                                   | 100 m (500 m)                    | 6 m  | 156 m                         |                       |                         |                               |          |               |     |      |          |               |     |      |          |               |     |       |
| <b>Communications power supply</b>         |                                  | 24-VDC DeviceNet power supply  |                               |                       |                         |                               |          |               |     |      |          |               |     |      |          |               |     |       |
| <b>Allowable voltage fluctuation range</b> |                                  | 11 to 25-VDC DeviceNet power supply  |                               |                       |                         |                               |          |               |     |      |          |               |     |      |          |               |     |       |
| <b>Current consumption</b>                 |                                  | 50 mA max. (24 VDC)  |                               |                       |                         |                               |          |               |     |      |          |               |     |      |          |               |     |       |
| <b>Maximum number of nodes</b>             |                                  | 64 (DeviceNet Configurator is counted as one node when connected)  |                               |                       |                         |                               |          |               |     |      |          |               |     |      |          |               |     |       |
| <b>Maximum number of slaves</b>            |                                  | 63   |                               |                       |                         |                               |          |               |     |      |          |               |     |      |          |               |     |       |
| <b>Error control checks</b>                |                                  | CRC errors   |                               |                       |                         |                               |          |               |     |      |          |               |     |      |          |               |     |       |
| <b>DeviceNet power supply</b>              |                                  | Supplied from DeviceNet communications connector   |                               |                       |                         |                               |          |               |     |      |          |               |     |      |          |               |     |       |

**Internal Block Diagram**

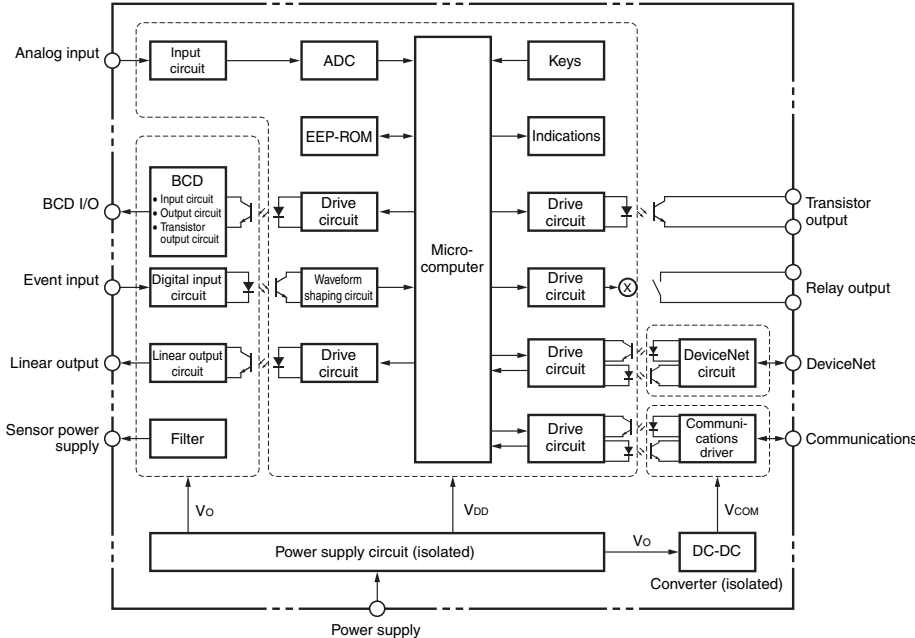

## Power Supply Derating Curve for Sensor (Reference Value)

With 12 V

With 10 V



- Note:** 1. The above values are for standard mounting. The derating curve differs depending on the mounting conditions.  
 2. Do not use the Sensor outside of the derating area (i.e., do not use it in the area labeled A in the above graphics). Doing so may occasionally cause deterioration or damage to internal components.

## Component Names and Functions

### Max/Min status indicator

Turns ON when the maximum value or minimum value is displayed in the RUN level.

### Level/bank display

In RUN level, displays the bank if the bank function is ON. (Turns OFF if the bank function is OFF.)  
 In other levels, displays the current level.

### Comparative output status indicators

Display the status of comparative outputs.

### Status indicators

| Display | Function   |
|---------|--|
| T-ZR    | Turns ON when the tare zero function is executed. Turns OFF if it is not executed or is cleared.                           |
| Zero    | Turns ON when the forced-zero function is executed. Turns OFF if it is not executed or is cleared. (Excluding the K3HB-H.) |
| Hold    | Turns ON/OFF when hold input turns ON/OFF.   |

### PV display

Displays PVs, maximum values, minimum values, parameter names, and error names.

### Position meter

Displays the position of the PV with respect to a desired scale.

### SV display

Displays SV and monitor values.

### SV display status indicators

| Display      | Function  |
|--------------|---|
| TG           | Turns ON when the timing signal turns ON. Otherwise OFF.                              |
| T            | Turns ON when parameters for which teaching can be performed are displayed.           |
| HH, H, L, LL | In RUN level, turn ON when the comparative set values HH, H, L, and LL are displayed. |



### MAX/MIN Key

Used to switch the display between the PV, maximum value, and minimum value and to reset the maximum and minimum values.

### LEVEL Key

Used to switch level.

### MODE Key

Used to switch the parameters displayed.

### SHIFT Key

Used to change parameter settings. When changing a set value, this key is used to move along the digits.

### UP Key

When changing a set value, this key is used to change the actual value. When a measurement value is displayed, this key is used to execute or clear the forced-zero function or to execute teaching.

# BCD Output Timing Chart

A REQUEST signal from a Programmable Controller or other external device is required to read BCD data.

## Single Sampling Data Output



The data is set in approximately 30 ms from the rising edge of the REQUEST signal and the DATA VALID signal is output. When reading the data from a Programmable Controller, start reading the data when the DATA VALID signal turns ON. The DATA VALID signal will turn OFF 40 ms later, and the data will turn OFF 16 ms after that.

## Continuous Data Output



Measurement data is output every 64 ms while the REQUEST signal remains ON.

**Note:** If HOLD is executed when switching between data 1 and data 2, either data 1 or data 2 is output depending on the timing of the hold signal. The data will not go LOW.



**Note:** Leave 20 ms min. between DATA VALID turning OFF and the REQUEST signal.

## Programmable Controller Connection Example

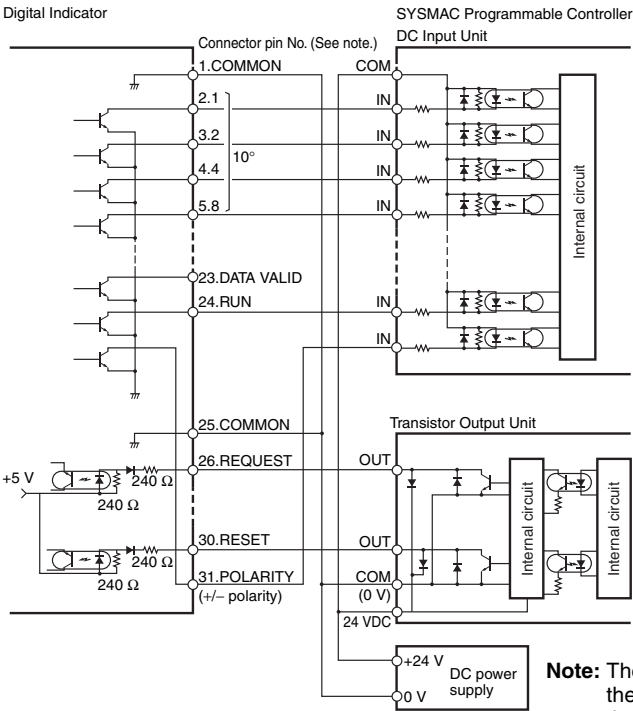

## Display Unit Connection Example

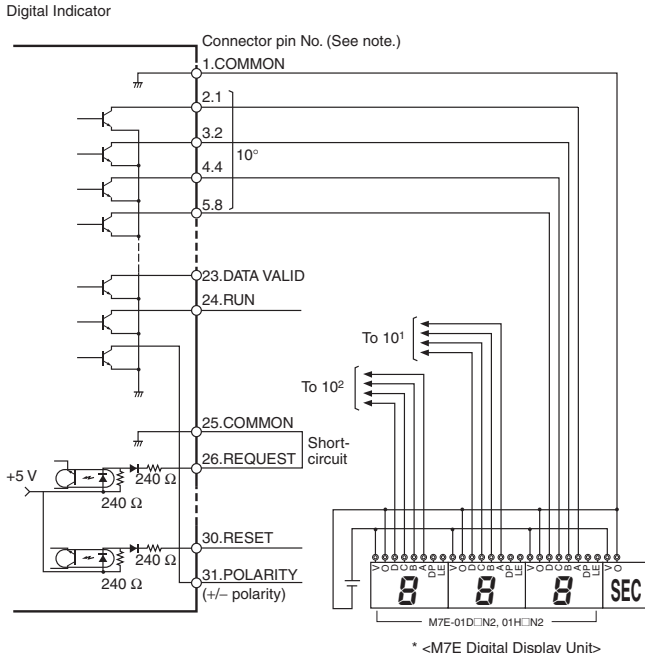

**Note:** The BCD output connector pin number is the D-sub connector pin number when the BCD Output Cable (sold separately) is connected. This number differs from the pin number for the Digital Indicator narrow pitch connector (manufactured by Honda Tsushin Kogyo Co., Ltd.).

\*M7E series were discontinued at the end of March, 2020.

Refer to the following User's Manual for application precautions and other information required when using the Digital Indicator:  
 K3HB-S/-X/-V/-H Digital Indicator User's Manual (Cat. No. N128)  
 The manual can be downloaded from the following site in PDF format: OMRON Industrial Web <http://www.fa.omron.co.jp>



# Connections

## Terminal Arrangement

**Note:** Insulation is used between signal input, event input, output, and power supply terminals.

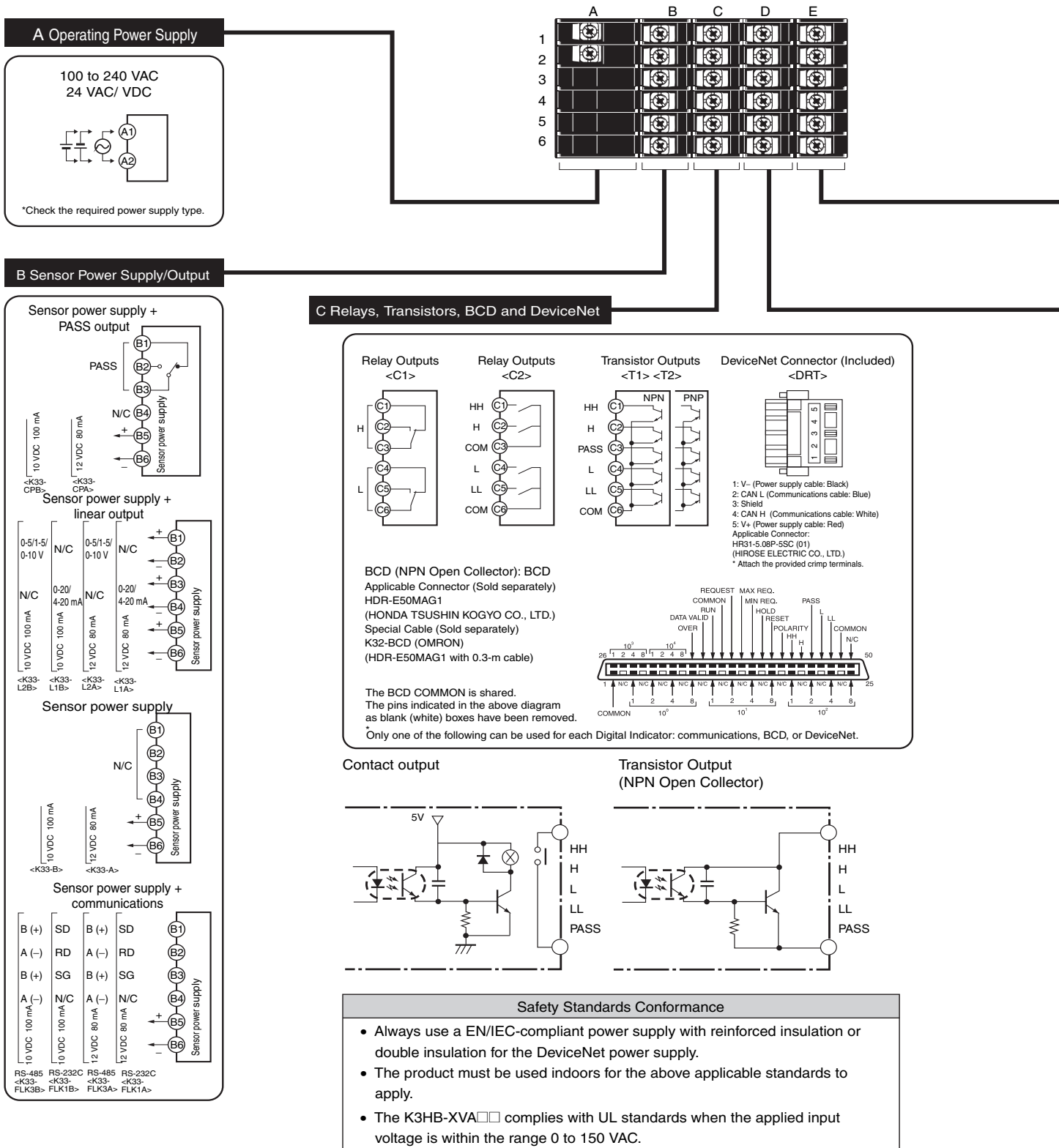

E Analog Input

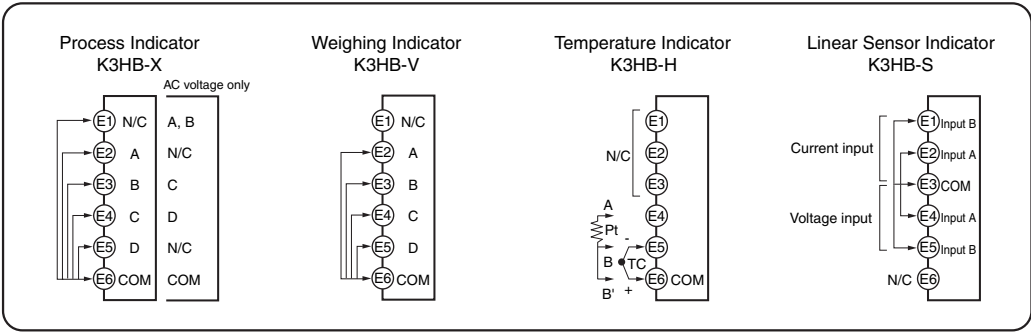

D Event Input

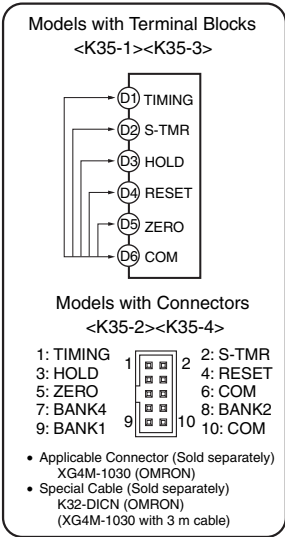

- Use terminal pin D6 as the common terminal.
- Use NPN open collector or no-voltage contacts for event input. PNP types are also available.

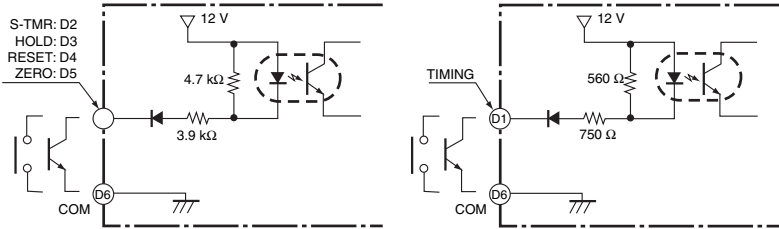

BCD Output Cable

| Model   | Shape   | Pin arrangement  |
|---------|---|--|
| K32-BCD | <p>Cover: HDR-E50LPA5 (manufactured by Honda Tsushin Co., Ltd.)<br/>Connector: HDR-E50MAG1 (manufactured by Honda Tsushin Co., Ltd.)</p> <p>D-sub connector (37-pin female)<br/>Cover: 17JE-37H-1A (manufactured by DDK)<br/>Connector: Equivalent to 17JE-13370-02 (manufactured by DDK)<br/>Stand: 17L-002A (manufactured by DDK)</p> | <p>COMMON → 1, 2, 4, 8, 10<sup>1</sup>, 10<sup>2</sup>, 10<sup>3</sup>, 10<sup>4</sup></p> <p>4, 8, 10<sup>4</sup></p> <p>OVER<br/>DATA VALID<br/>RUN<br/>COMMON<br/>REQUEST<br/>MAX REQ.<br/>MIN REQ.<br/>HOLD<br/>RESET<br/>POLARITY<br/>HH<br/>H<br/>PASS<br/>L<br/>LL<br/>COMMON</p> |

Note: The BCD Output Cable has a D-sub plug. Cover: 17JE-37H-1A (manufactured by DDK); Connector: equivalent to 17JE-23370-02 (D1) (manufactured by DDK)

Special Cable (for Event Inputs with 8-pin Connector)

| Model    | Appearance  | Wiring   |         |             |   |        |   |       |   |      |   |       |   |      |   |     |   |       |   |       |   |       |    |     |
|----------|-------------|--|---------|-------------|---|--------|---|-------|---|------|---|-------|---|------|---|-----|---|-------|---|-------|---|-------|----|-----|
| K32-DICN |             | <table border="1"> <thead> <tr> <th>Pin No.</th> <th>Signal name</th> </tr> </thead> <tbody> <tr><td>1</td><td>TIMING</td></tr> <tr><td>2</td><td>S-TMR</td></tr> <tr><td>3</td><td>HOLD</td></tr> <tr><td>4</td><td>RESET</td></tr> <tr><td>5</td><td>ZERO</td></tr> <tr><td>6</td><td>COM</td></tr> <tr><td>7</td><td>BANK4</td></tr> <tr><td>8</td><td>BANK2</td></tr> <tr><td>9</td><td>BANK1</td></tr> <tr><td>10</td><td>COM</td></tr> </tbody> </table> | Pin No. | Signal name | 1 | TIMING | 2 | S-TMR | 3 | HOLD | 4 | RESET | 5 | ZERO | 6 | COM | 7 | BANK4 | 8 | BANK2 | 9 | BANK1 | 10 | COM |
| Pin No.  | Signal name |  |         |             |   |        |   |       |   |      |   |       |   |      |   |     |   |       |   |       |   |       |    |     |
| 1        | TIMING      |  |         |             |   |        |   |       |   |      |   |       |   |      |   |     |   |       |   |       |   |       |    |     |
| 2        | S-TMR       |  |         |             |   |        |   |       |   |      |   |       |   |      |   |     |   |       |   |       |   |       |    |     |
| 3        | HOLD        |  |         |             |   |        |   |       |   |      |   |       |   |      |   |     |   |       |   |       |   |       |    |     |
| 4        | RESET       |  |         |             |   |        |   |       |   |      |   |       |   |      |   |     |   |       |   |       |   |       |    |     |
| 5        | ZERO        |  |         |             |   |        |   |       |   |      |   |       |   |      |   |     |   |       |   |       |   |       |    |     |
| 6        | COM         |  |         |             |   |        |   |       |   |      |   |       |   |      |   |     |   |       |   |       |   |       |    |     |
| 7        | BANK4       |  |         |             |   |        |   |       |   |      |   |       |   |      |   |     |   |       |   |       |   |       |    |     |
| 8        | BANK2       |  |         |             |   |        |   |       |   |      |   |       |   |      |   |     |   |       |   |       |   |       |    |     |
| 9        | BANK1       |  |         |             |   |        |   |       |   |      |   |       |   |      |   |     |   |       |   |       |   |       |    |     |
| 10       | COM         |  |         |             |   |        |   |       |   |      |   |       |   |      |   |     |   |       |   |       |   |       |    |     |

## Main Functions

### Measurement

#### Input Calculation

- Two input circuits are provided. The input ranges for these circuits can be set independently. For example, one can be set to 4 to 20 mA and the other can be set to 1 to 5 V.
- In addition to calculations such as K (constant)-A (input for one circuit), it is possible to perform calculations based on the inputs for both circuits, such as A+B and A-B, making it possible to perform thickness measurement and level-difference measurement using displacement and length-measuring sensors.

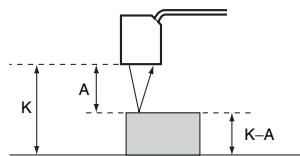

#### Timing Hold

##### Normal

- Continuously performs measurement and always outputs based on comparative results.

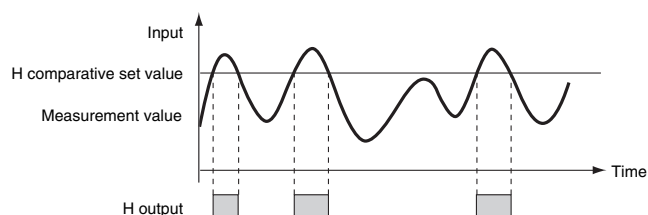

##### Sampling Hold

- Holds the measurement at the rising edge of the TIMING signal.

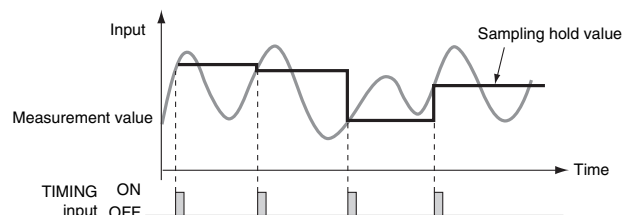

##### Peak Hold/Bottom Hold

- Measures the maximum (or minimum) value in a specified period.

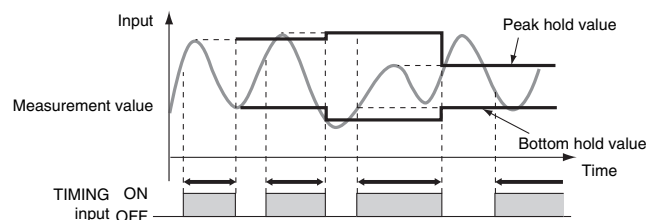

##### Peak-to-peak Hold

- Measures the difference between the maximum and minimum values in a specified period.

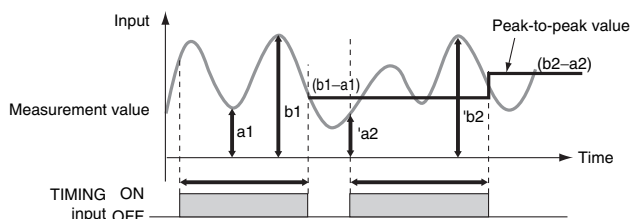

#### Scaling

Scaling converts input signals in any way required before displaying them. The values can be manipulated by shifting, inverting, or +/- reversing.

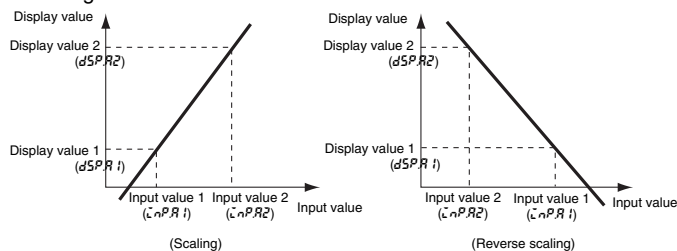

#### Teaching

Settings for scaling can be made using the present measurement values instead of inputting values with the SHIFT and UP Keys. This is a convenient function for making the settings while monitoring the operating status.

#### Standby Sequence

Turns the comparative output OFF until the measurement value enters the PASS range.

#### Average Processing

Average processing of input signals with extreme changes or noise smooths out the display and makes control stable.

#### Previous Average Value Comparison

Slight changes can be removed from input signals to detect only extreme changes.

## Input Compensation/Display

### Forced-zero

Forces the present value to 0. (Convenient for setting reference values or deducting tares for weight measurement.)

### Tare Zero

Shifts the current value measured with a forced zero to 0 again. It is possible to measure two or more compounds separately and then, by releasing the tare zero and forced-zero, measure the combined total.

### Zero-trimming

Compensates for mild fluctuations in input signals due to factors such as sensor temperature drift, based on OK (PASS) data at measurement. (This function can be used with sampling hold, peak hold, or bottom hold.)

### Zero-limit

Changes the display value to 0 for input values less than the set value. It is enabled in normal mode only. (This function can be used, for example, to stop negative values being displayed or to eliminate flickering and minor inconsistencies near 0.)

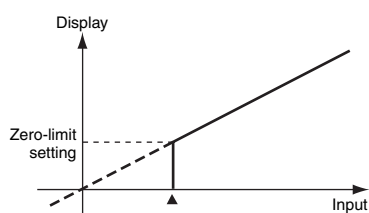

### Interruption Memory

- The minimum and maximum values when the power supply is turned OFF can be saved if interruption memory is turned ON.
- If interruption memory is ON, the maximum and minimum values after the last resetting will be displayed.
- If interruption memory is OFF, the maximum and minimum values will be displayed after the power supply is turned ON (or after the reset input is performed).

### Display Refresh Period

The display refresh period can be lengthened to reduce flickering and thereby make the display easier to read.

### Display Color Selection

Values can be displayed in either red or green. With comparative output models, the display color can also be set to change according to the status of comparative outputs (e.g., green to red or red to green).

Example) Setting: Green

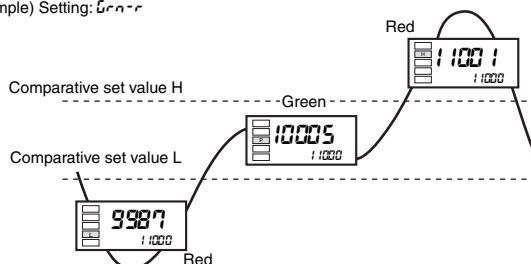

### Display Value Selection

The current display value can be selected from the present value, the maximum value, and the minimum value.

### Step Value

It is possible to specify (i.e., restrict) the values that the smallest displayed digit can change by. For example, if the setting is 2, the smallest digit will only take the values 0, 2, 4, 6, or 8 and if the setting is 5, it will only take the values 0 or 5. If the setting is 10, it will only take the value of 0.

## Output

### Comparative Output Pattern

The output pattern for comparative outputs can be selected. In addition to high/low comparison with set values, output based on level changes is also possible. (Use the type of output pattern appropriate for the application.)

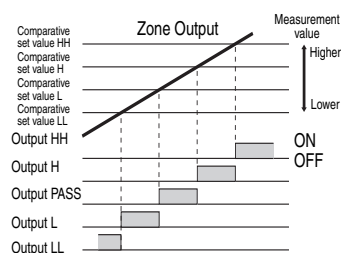
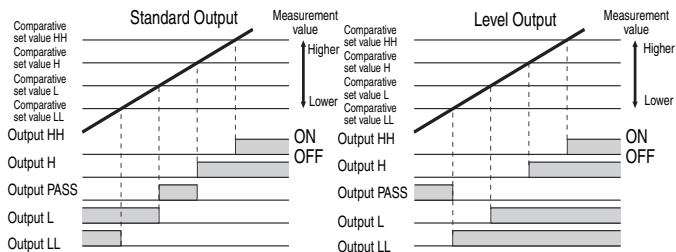

### Output Logic

Reverses the output operation of comparative outputs for comparative results.

### Hysteresis

Prevents comparative output chattering when the measurement value fluctuates slightly near the set value.

Example: Comparative Output Pattern (Standard Output)

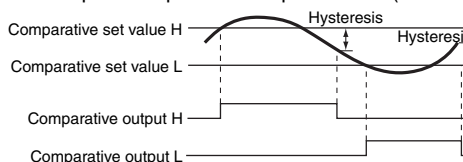

### Startup Compensation Timer

Measurement can be stopped for a set time using external input.

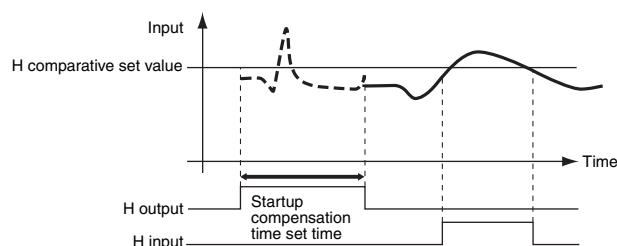

### PASS Output Change

Comparative results other than PASS and error signals can be output from the PASS output terminal.

## Dimensions

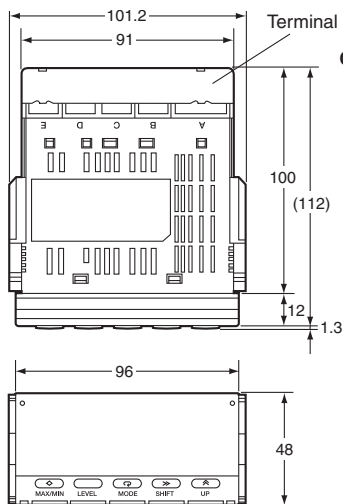

### Character Size for Main Display (mm)

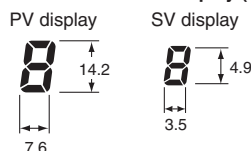

### Panel Cutout Dimensions

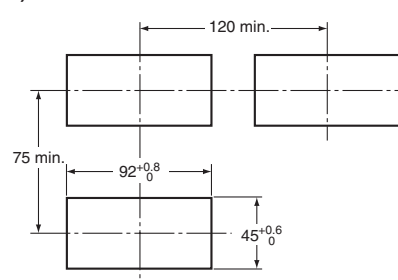

Mounting Recommended Panel Thickness 1 to 8 mm. Mount the product horizontally.

\*DeviceNet models: 97 mm Terminal: M3, Terminal Cover: Accessory

## Wiring Precautions

- For terminal blocks, use the crimp terminals suitable for M3 screws.
- Tighten the terminal screws to the recommended tightening torque of approx. 0.5 N·m.
- To prevent inductive noise, separate the wiring for signal lines from that for power lines.

## Wiring

- Use the crimp terminals suitable for M3 screws shown below.

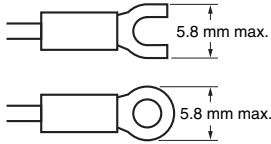

## Unit Stickers

- Select the appropriate units from the unit sticker sheets provided and attach the sticker to the Indicator.

|       |       |     |    |     |    |                |   |
|-------|-------|-----|----|-----|----|----------------|---|
| V     | A     | V   | A  | %   | J  | Pa             | Ω |
| s     | /     | N   | m  | W   | °C | m <sup>3</sup> | k |
| °F    | g     | min | mm | rpm |    |                |   |
| VA    | mV    | mA  | Hz |     |    |                |   |
| m/min | OMRON |     |    |     |    |                |   |
| OUT   | OUT   |     |    |     |    |                |   |

**Note:** When using for meters, such as weighing meters, use the units specified by regulations on weights and measures.

## Mounting Method

1. Insert the K3HB into the mounting cutout in the panel.
2. Insert watertight packing around the Unit to make the mounting watertight.

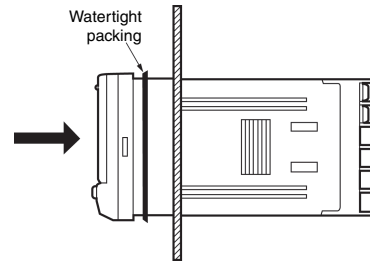

3. Insert the fixture into the grooves on the left and right sides of the rear case and push until it reaches the panel and is fixed in place.

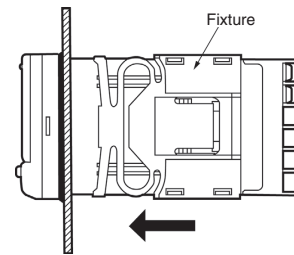

## LCD Field of Vision

The K3HB is designed to have the best visibility at the angles shown in the following diagram.

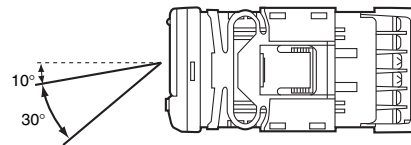

## Watertight Cover

Y92A-49N

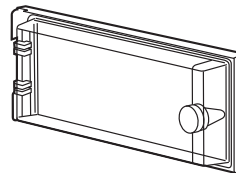

## Rubber Packing

K32-P1

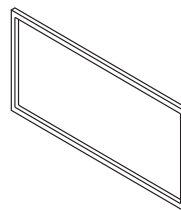

If the rubber packing is lost or damaged, it can be ordered using the following model number: K32-P1.

(Depending on the operating environment, deterioration, contraction, or hardening of the rubber packing may occur and so, in order to ensure the level of waterproofing specified in NEMA4, periodic replacement is recommended.)

**Note:** Rubber packing is provided with the Controller.

ALL DIMENSIONS SHOWN ARE IN MILLIMETERS.

To convert millimeters into inches, multiply by 0.03937. To convert grams into ounces, multiply by 0.03527.

In the interest of product improvement, specifications are subject to change without notice.

## Terms and Conditions Agreement

### Read and understand this catalog.

Please read and understand this catalog before purchasing the products. Please consult your OMRON representative if you have any questions or comments.

### Warranties.

(a) Exclusive Warranty. Omron's exclusive warranty is that the Products will be free from defects in materials and workmanship for a period of twelve months from the date of sale by Omron (or such other period expressed in writing by Omron). Omron disclaims all other warranties, express or implied.

(b) Limitations. OMRON MAKES NO WARRANTY OR REPRESENTATION, EXPRESS OR IMPLIED, ABOUT NON-INFRINGEMENT, MERCHANTABILITY OR FITNESS FOR A PARTICULAR PURPOSE OF THE PRODUCTS. BUYER ACKNOWLEDGES THAT IT ALONE HAS DETERMINED THAT THE PRODUCTS WILL SUITABLY MEET THE REQUIREMENTS OF THEIR INTENDED USE.

Omron further disclaims all warranties and responsibility of any type for claims or expenses based on infringement by the Products or otherwise of any intellectual property right. (c) Buyer Remedy. Omron's sole obligation hereunder shall be, at Omron's election, to (i) replace (in the form originally shipped with Buyer responsible for labor charges for removal or replacement thereof) the non-complying Product, (ii) repair the non-complying Product, or (iii) repay or credit Buyer an amount equal to the purchase price of the non-complying Product; provided that in no event shall Omron be responsible for warranty, repair, indemnity or any other claims or expenses regarding the Products unless Omron's analysis confirms that the Products were properly handled, stored, installed and maintained and not subject to contamination, abuse, misuse or inappropriate modification. Return of any Products by Buyer must be approved in writing by Omron before shipment. Omron Companies shall not be liable for the suitability or unsuitability or the results from the use of Products in combination with any electrical or electronic components, circuits, system assemblies or any other materials or substances or environments. Any advice, recommendations or information given orally or in writing, are not to be construed as an amendment or addition to the above warranty.

See <http://www.omron.com/global/> or contact your Omron representative for published information.

### Limitation on Liability: Etc.

OMRON COMPANIES SHALL NOT BE LIABLE FOR SPECIAL, INDIRECT, INCIDENTAL, OR CONSEQUENTIAL DAMAGES, LOSS OF PROFITS OR PRODUCTION OR COMMERCIAL LOSS IN ANY WAY CONNECTED WITH THE PRODUCTS, WHETHER SUCH CLAIM IS BASED IN CONTRACT, WARRANTY, NEGLIGENCE OR STRICT LIABILITY.

Further, in no event shall liability of Omron Companies exceed the individual price of the Product on which liability is asserted.

### Suitability of Use.

Omron Companies shall not be responsible for conformity with any standards, codes or regulations which apply to the combination of the Product in the Buyer's application or use of the Product. At Buyer's request, Omron will provide applicable third party certification documents identifying ratings and limitations of use which apply to the Product. This information by itself is not sufficient for a complete determination of the suitability of the Product in combination with the end product, machine, system, or other application or use. Buyer shall be solely responsible for determining appropriateness of the particular Product with respect to Buyer's application, product or system. Buyer shall take application responsibility in all cases.

NEVER USE THE PRODUCT FOR AN APPLICATION INVOLVING SERIOUS RISK TO LIFE OR PROPERTY OR IN LARGE QUANTITIES WITHOUT ENSURING THAT THE SYSTEM AS A WHOLE HAS BEEN DESIGNED TO ADDRESS THE RISKS, AND THAT THE OMRON PRODUCT(S) IS PROPERLY RATED AND INSTALLED FOR THE INTENDED USE WITHIN THE OVERALL EQUIPMENT OR SYSTEM.

### Programmable Products.

Omron Companies shall not be responsible for the user's programming of a programmable Product, or any consequence thereof.

### Performance Data.

Data presented in Omron Company websites, catalogs and other materials is provided as a guide for the user in determining suitability and does not constitute a warranty. It may represent the result of Omron's test conditions, and the user must correlate it to actual application requirements. Actual performance is subject to the Omron's Warranty and Limitations of Liability.

### Change in Specifications.

Product specifications and accessories may be changed at any time based on improvements and other reasons. It is our practice to change part numbers when published ratings or features are changed, or when significant construction changes are made. However, some specifications of the Product may be changed without any notice. When in doubt, special part numbers may be assigned to fix or establish key specifications for your application. Please consult with your Omron's representative at any time to confirm actual specifications of purchased Product.

### Errors and Omissions.

Information presented by Omron Companies has been checked and is believed to be accurate; however, no responsibility is assumed for clerical, typographical or proofreading errors or omissions.

2020.4

In the interest of product improvement, specifications are subject to change without notice.

**OMRON Corporation**  
Industrial Automation Company

<http://www.ia.omron.com/>

(c)Copyright OMRON Corporation 2020 All Right Reserved.